

Table of Contents

INTRODUCTION 1

About this Manual 1-1
Safety Messages Used in this Manual 1-1
Owner InfoCase 1-2
Chassis Owner’s Manual 1-2
Pre-Delivery Inspection 1-2
Front Axle Tire Alignment 1-2
Service and Assistance 1-2
Reporting Safety Defects 1-2
Vehicle Certification Label 1-3
Body and Chassis Specifications 1-4
Tank Capacities 1-5
Owner Information 1-6
Emergency Information 1-6
2006 New Vehicle Limited Warranty 1-7

SAFETY & PRECAUTIONS 2

General Warnings 2-1
Driving 2-1
Formaldehyde Information 2-1
LP Gas Leak Detector 2-1
Carbon Monoxide Warning 2-2
Carbon Monoxide Alarm 2-2
Smoke Alarm 2-3
Fire Extinguisher 2-3
Emergency Exits 2-4
Roadside Emergency 2-4
Jump Starting 2-5
Engine Overheat 2-6
Effects of Prolonged Occupancy 2-6

DRIVING YOUR MOTOR HOME 3

Seats 3-1
Seat Belts 3-2
Child Restraints 3-3
Power Door Locks 3-3
Power Electric Mirrors 3-4
Rearview Monitor System 3-6

Electronic Compass and Outside Thermometer	3-6
Power Sunvisors	3-6
Vehicle Information Center	3-6
Parking Brakes	3-7
Exhaust Restriction Braking System	3-7
Map Light Switch	3-8
Hazard Warning Lights	3-8
Signal Lever/Headlight Hi/Lo Beam	3-9
Steering Column Tilt/Telescope	3-9
Aux Start Switch	3-9
Auto Air Conditioner/Heater	3-10
Aux Fan Switch	3-10
In-Dash Radio	3-10
Fuel Selection	3-11
Filling the Fuel Tank	3-11
Starting and Stopping Engine	3-11
Engine Block Heater	3-12
Engine Access Grille – Rear	3-12
Engine Top Access Covers – Rear	3-12
Fuel/Water Separator	3-13
Engine Cooling System	3-14
Chassis Battery Cutoff Switch	3-14
Automotive 12-Volt Fuses and Circuit Breakers	3-14
Windshield Washers and Wipers	3-15
Tires	3-15
Suspension Alignment and Tire Balance	3-15
Lights	3-16
Loading the Vehicle	3-16
Roof Loading	3-17
Weighing Your Loaded Vehicle	3-17
Car or Trailer Towing	3-18
Trailer Wiring Connector	3-20
Towing Guidelines	3-20
Mountain Driving	3-20
Tool and Ladder Storage	3-21
Storage Compartment Doors	3-22
Air Hose Connector	3-22

APPLIANCES & SYSTEMS 4

Refrigerator	4-1
Ice Maker	4-1
Refrigerator Service Access Compartment	4-1

Range and Oven	4-2
Microwave Oven	4-2
Range Hood	4-3
OnePlace Systems Monitor Panel	4-3
Solar Charger Panel	4-5
Powerline Energy Management System	4-5
Gas/Electric Water Heater	4-6
Pressure-Temperature Relief Valve	4-6
Motor Aid Water Heater	4-7
Water Heater By-pass Valve	4-8
LP Gas Furnace	4-8
Electronic Thermostat	4-8
Thermostat Operation	4-10
Heat Pump	4-10
Central Air Conditioner	4-11
Air Conditioner Filter	4-11
Electric Entrance Step	4-12
Stepwell Cover	4-12
Windows	4-13
Power Roof Vent	4-13
LP GAS 5	
LP Gas Supply	5-1
Safe Use of the LP Gas System	5-2
LP Gas Warnings and Precautions	5-3
Pressure Regulator	5-4
ELECTRICAL 6	
Electrical Cautions	6-1
110-Volt AC System	6-1
External Power Cord	6-1
Power Center	6-3
Inverter/Charger Unit - 2000W	6-4
110-Volt Circuit Breakers	6-4
110-Volt Receptacles (Outlets)	6-5
Ground Fault Circuit Interrupter	6-5
Auxiliary 110-Volt Generator	6-6
12-Volt DC System	6-7
Battery Information	6-7
Auxiliary Battery (Aux Batt) Switch	6-7
Battery Access	6-7
Battery Care	6-8
12-Volt Fuses and Circuit Breakers	6-9

PLUMBING 7

Fresh Water System 7-1

Water Pump 7-2

Water Purifier System 7-3

Disinfecting Fresh Water Systems on RV's 7-4

Shower Hose Vacuum Breaker 7-5

Exterior Shower 7-5

Toilet 7-5

Waste Water System (Holding Tanks) 7-5

Utility Light 7-8

Water Drain Valves 7-8

Winterizing Procedure 7-9

Water System Drain Valve Locations 7-14

ENTERTAINMENT 8

Video Control Center 8-1

Front TV Ignition Switch Interlock 8-1

DVD/VCR Combo Player and Home Theater Surround Sound 8-1

DC-AC Inverter - 600 Watt 8-2

TV Antenna 8-2

Portable Satellite Dish, Cable TV and Phone Hook-ups (Input) 8-3

FURNITURE & SOFTGOODS 9

Swivel Glider Lounge Chair 9-1

Sleeping Facilities 9-2

Dinette/Bed Conversion 9-2

Rest Easy Multi-Position Lounge 9-3

Nighter Pleated Blinds 9-5

Wood Furniture and Cabinetry 9-5

SLIDEOUT ROOMS 10

Slideout Room Extension 10-1

Slideout Room Troubleshooting 10-3

Slideout Room Emergency Retraction Procedures 10-4

Checking Hydraulic Oil Level 10-7

MAINTENANCE & STORAGE 11

Sealants 11-1

Roof 11-1

Underbody 11-1

Exterior Finish 11-2

Care of Decals 11-2

Front End Masks and Paint Damage 11-2

Headlights and Exterior Lights 11-3

Plastic Parts - Cleaning	11-3
Interior Softgoods	11-4
Cabinetry	11-5
Vinyl Wallboard	11-5
Care and Maintenance of your Solid Surface Countertop	11-5
Galley Sink	11-6
Range and Refrigerator	11-6
Bathroom	11-6
Doors and Windows	11-6
Nighter Blinds	11-7
Preparing Vehicle for Storage	11-7
Removal From Storage	11-8
Chassis Service and Maintenance	11-9
Coach Maintenance Chart	11-10
Recommended Sealant Application	11-13

SECTION 1 INTRODUCTION

Congratulations! We welcome you to the exciting world of motor home travel and camping. You will find it convenient and enjoyable to have all the comforts of home and still enjoy the great outdoors wherever you choose to go.

Your motor home has been carefully designed, engineered and manufactured to provide dependability as well as safety. Before sliding into the driver's seat, please become familiar with operations and features. This manual was prepared to aid you in the proper care and operation of the vehicle and equipment. We urge you to read it completely. In addition, spend some time with the dealer when you take delivery to learn all you can about your new motor home.

ABOUT THIS MANUAL

Please read this operator's manual completely to understand how everything in your coach works before taking it on its "maiden voyage."

NOTE: This manual describes many features of your motor home and includes instructions for its safe use. This manual, including photographs and illustrations, is of a general nature only. Some equipment and features described or shown in this manual may be optional or unavailable on your model. Because of Winnebago Industries' continuous program of product improvement, it is possible that recent product changes and information may not be included. The instructions included in this manual are intended as a guide, and in no way extend the responsibilities of Winnebago Industries beyond the standard written warranty as presented in this manual. The descriptions, illustrations, and specifications in this manual were correct at the time of printing. We reserve the right to change specifications

or design without notice, and without incurring obligation to install the same on products previously manufactured.

SAFETY MESSAGES USED IN THIS MANUAL

Throughout this manual, certain items are labeled Danger, Warning, Caution or Note. These terms alert you to precautions that may involve damage to your vehicle or a risk to your personal safety. Read and follow them carefully.



DANGER

DANGER indicates a directly hazardous situation which, if not avoided, will result in death or serious personal injury.



WARNING

WARNING indicates a potentially hazardous situation which, if not avoided, could result in death or serious personal injury.



CAUTION

CAUTION indicates a potentially hazardous situation which, if not avoided, could result in damage mainly to equipment or property, but in some cases may also result in minor or moderate personal injury.

NOTE: A 'Note' is not necessarily safety related but indicates a recommendation or special point of information that could assist in understanding the use or care of a feature item.

OWNER INFOCASE

The materials in your Owner InfoCase contain warranty information and operating and maintenance instructions for the various appliances and components in your motor home.

NOTE: Many of the instruction sheets and manuals for the various appliances and components have been incorporated into the Operator Manual Supplement for your convenience. Throughout the Operator's Manual when referred to the InfoCase keep in mind that much of this information will be found in the Operator Manual Supplement. Please read the FAQ in section 1 of the Operator Manual Supplement for more details.

CHASSIS OWNER'S MANUAL

Throughout this manual, frequent reference is made to the vehicle chassis owner's manual that is provided by the manufacturer of the chassis on which this motor home is built (e.g., Freightliner). Consult the chassis owner's manual for operating safety and maintenance instructions pertaining to the chassis section of the motor home.

PRE-DELIVERY INSPECTION

This motor home has been thoroughly inspected before shipment. Your dealer is responsible for performing a complete pre-delivery inspection of the chassis and all motor home components.

As a part of the pre-delivery inspection procedure, the dealer is responsible for road testing the motor home; noting and correcting any problems before delivery.

FRONT AXLE TIRE ALIGNMENT

We recommend that you have the front suspension and steering alignment checked and adjusted after you have fully loaded the vehicle

according to your needs. Thereafter, have alignment inspected periodically to maintain vehicle steering performance and prevent uneven tire wear.

SERVICE AND ASSISTANCE

Your dealer will be glad to provide any additional information you need, as well as answer any questions you might have about operating the equipment in your motor home. When it comes to service, remember that your dealer knows your vehicle best and is interested in your satisfaction. Your dealer will provide quality maintenance and any other assistance that you may require during your ownership of this vehicle.

If you need warranty repairs while traveling you may take your motor home to any authorized Winnebago or Itasca dealership and request their assistance.

See the dealership directory in your Owner InfoCase.

REPORTING SAFETY DEFECTS

If you believe that your vehicle has a defect which could cause a crash or could cause injury or death, you should immediately inform the National Highway Traffic Safety Administration (NHTSA) in addition to notifying Winnebago Industries, Inc.

If NHTSA receives similar complaints, it may open an investigation, and if it finds that a safety defect exists in a group of vehicles, it may order a recall and remedy campaign. However, NHTSA cannot become involved in individual problems between you, your dealer, or Winnebago Industries.

To contact NHTSA, you may either call the Auto Safety Hotline toll-free at 1-800-424-9393 (or 366-0123 in Washington, D.C. area) or write to: NHTSA, U.S. Department of Transportation, Washington, D.C. 20590. You can also obtain other information about motor vehicle safety from the Hotline.

VEHICLE CERTIFICATION LABEL

This label contains vehicle identification and other important reference information. The label is affixed to the armrest panel or wall to the left of the driver seat.

EXPLANATION OF DATA

1. Chassis manufacturer.
2. Chassis manufacture date.
3. Month and year of manufacture at Winnebago Industries.
4. Gross Vehicle Weight Rating: Total permissible weight of the vehicle, including driver, passengers, total cargo carried (including all liquids) and equipped with all options.
5. Gross Axle Weight Rating: Total permissible weight allowed for the front and rear axles (listed in pounds and kilograms).
6. Suitable Tire Choice: Tires recommended to meet handling and safety requirements. When replacing any of the tires on your vehicle, always replace with a tire that meets these specifications.
7. Suitable Rim Choice: Wheel rims recommended to meet handling and safety requirements. When replacing any of the rims on your vehicle, always replace with a rim that meets these specifications.
8. Cold Inflation Pressure: Inflation pressures at Gross Axle Weight Ratings recommended (while Cold) for the tires originally equipped on your vehicle. These pressure levels must be maintained to assure proper handling, safety and fuel economy.
9. Rear Axle Wheel Configuration: Single or Dual as it relates to the inflation.
10. Serial Number: This is the serial number assigned to the completed vehicle by Winnebago Industries.
11. Vehicle Identification Number (VIN): This number identifies the chassis on which the motor home is built. The 10th digit of the VIN designates the chassis model year. (5=2005, 6=2006, etc.). This information is useful when ordering chassis repair parts.
12. Type: States the NHTSA designated usage classification for your motor home. MPV signifies a Multi-purpose Passenger Vehicle.
13. Model: Lists the Winnebago product model number of your vehicle.
14. Color: Signifies the color code number of the decor used throughout the vehicle. This number is necessary for ordering replacement cushions, curtains, carpet, etc.

BODY AND CHASSIS SPECIFICATIONS

Model	36SG
Length (Bumper to Bumper)	36' 6"
Interior Width	8' 0.5"
Exterior Width	8' 5.5"
Interior Height	6' 8"
Exterior Height *	11' 8"*
Exterior Storage (cu. ft.)	121.9
5-Speed GCWR (lbs.)	33,000
GVWR (lbs.)	27,910
GAWR - Front (lbs.)	10,410
GAWR - Rear (lbs.)	17,500
Wheelbase	228"
6-Speed GCWR (lbs.)	37,910
GVWR (lbs.)	27,910
GAWR - Front (lbs.)	10,410
GAWR - Rear (lbs.)	17,500
Wheelbase	228"

Note: The height of each model is based on the curb weight of a typically equipped unit and is measured to the highest standard feature on the roof. The actual height of a vehicle may vary by several inches depending on equipment variations. Refer to Section 3 for Towing Guidelines.

*If equipped with digital satellite dish, add 3".
If equipped with In-Motion dome, add 7".

TANK CAPACITIES

Chassis Fuel Tank

Freightliner - Diesel fuel - dual fills (all models) 90 gal.

LP Gas Tank

Model 36SG 23.6 gal.* (30 gal. w.c.)

Fresh Water Tank

Model 36SG 82 gal.

Water Heater

Model 36SG 10 gal.

HT1 - Black Water Holding Tank

Model 36SG (Toilet) 54 gal.

HT2 - Gray Water Holding Tank

Model 36SG (Galley, Shower & Lavatory) 54 gal.

**LP Gas tank capacity shown is the usable “full” LP gas capacity, which is 80% of the tank manufacturer’s listed water capacity (w.c. shown in parenthesis). An LP tank must have at least 20% of tank volume free to allow for expansion and proper vaporization of the liquid fuel. The tank is also equipped with mandatory safety shut-off equipment that prevents filling above this level.*

NOTE: Capacities shown are approximate volumes based on computer design calculations. Usable capacities may vary according to fabrication and installation of tanks and compartments.

**SECTION 1
INTRODUCTION**

Journey SE

OWNER INFORMATION

Owner's Name _____

Street Address _____

City and State (or Province in Canada) _____

Motor Home Serial Number _____

Vehicle Chassis Identification Number (VIN) _____

Vehicle Mileage at Time of Delivery _____

Selling Dealer Name and Address _____

EMERGENCY INFORMATION

YOUR WINNEBAGO INDUSTRIES DEALER

Name _____

Address _____

Contact Person _____

Phone _____

CHASSIS DEALER/SERVICE CENTER

Name _____

Address _____

Contact Person _____

Phone _____

INSURANCE POLICY

Company _____

Policy Number _____

Phone _____

**2006 NEW VEHICLE LIMITED WARRANTY
WINNEBAGO INDUSTRIES, INC.**



WARRANTY COVERAGE TO OWNER

Winnebago Industries, Inc. of Forest City, Iowa warrants each new Winnebago Industries motor home to the owner for use in the U.S.A. and Canada as follows:

WARRANTY PERIOD

The Warranty Period for all coverages begins on the date the vehicle is delivered to the first retail purchaser or first placed in service as a demonstrator or company vehicle.

BASIC COVERAGE

The basic Warranty Period is 12 months or 15,000 miles (24,135 kilometers), on the odometer, whichever occurs first. This is the only warranty authorized by Winnebago. There are no other promises, representations or warranties concerning the matters set forth herein. Winnebago Industries does not authorize any person to create for it any other obligations or liability in connection with this vehicle. ANY IMPLIED WARRANTY OF MERCHANTABILITY OR FITNESS FOR A PARTICULAR PURPOSE APPLICABLE TO THIS VEHICLE IS LIMITED IN DURATION TO THE DURATION OF THIS WRITTEN WARRANTY AS HEREINBEFORE OR HEREINAFTER PROVIDED. THE PERFORMANCE OF REPAIRS IS THE EXCLUSIVE REMEDY UNDER THIS WRITTEN WARRANTY OR ANY IMPLIED WARRANTY. WINNEBAGO INDUSTRIES SHALL NOT BE LIABLE FOR INCIDENTAL OR CONSEQUENTIAL DAMAGES FOR LOSS OF TIME, INCONVENIENCE, OR OTHER CONSEQUENTIAL DAMAGE INCLUDING EXPENSE FOR GASOLINE, TELEPHONE, TRAVEL, LODGING, LOSS OR DAMAGE TO PERSONAL PROPERTY, OR LOSS OF REVENUE RESULTING FROM BREACH OF THIS WRITTEN WARRANTY OR ANY IMPLIED WARRANTY. Some states do not allow limitations on how long an implied warranty will last or the exclusion or limitation of incidental or consequential damages, so the above limitations or exclusions may not apply to you.

ITEMS NOT SUBJECT TO WARRANTY COVERAGE.

- Chassis, Drivetrain and related components*
- Wheels*
- Tires*
- Service Items, such as Windshield Wiper Blades, Lubricants, Fluids & Filters
- Adjustments

*These items are covered under the manufacturer's individual warranty.

This warranty gives you specific legal rights and you may also have other rights which vary from state to state.

Also, this warranty shall not apply to failures, damage or malfunctions resulting from normal wear, misuse, abuse, negligence, alteration, accident, fire, improper repair of the vehicle or failure to follow recommended maintenance requirements.

36 MONTHS/36,000 MILE STRUCTURAL WARRANTY

At the expiration of the Basic Coverage and for the remainder of the period of 36 months or 36,000 miles (57,924 kilometers), on the odometer, whichever occurs first, Winnebago Industries warrants the following:

1. Structural defects of the subfloor, floor, and slide-out room assembly. Floor lamination failure and lamination failure of the subfloor panels and risers are covered by the structural warranty.
2. Body Thermo-Panel® Lamination of the sidewalls and backwall against delamination. Body Thermo-Panel® Lamination is the bonding of the exterior skin and the interior paneling to an insulating core material. Delamination (separation of layers)

caused by other factors such as physical damage or failure to properly maintain sealants is not covered by this warranty.

WINNEBAGO INDUSTRIES' RESPONSIBILITY

Any part of the vehicle subject to warranty which is found to be defective in material or workmanship, will be repaired or replaced at Winnebago Industries' option upon notice of the defect without charge to the customer for parts or labor. While any Winnebago Industries motor home dealer can perform warranty service, we recommend you return to the dealership that sold you your vehicle. If you are touring or have moved, contact any Winnebago Industries motor home dealer in the United States or Canada for warranty service.

CUSTOMER RESPONSIBILITY WHEN REPAIRS ARE NEEDED

If a part of the system covered by this warranty fails to function or requires service during the warranty period:

1. Promptly take the vehicle to the selling dealer for repair or inspection.
2. Written notice of defects must be given to the selling dealer or manufacturer no later than 10 days after the expiration of the warranty.
3. If the dealer is incapable of making the repairs, request that he contact Winnebago Industries, Inc.
4. If, after the above steps are completed and the repair is not made, the customer should contact Winnebago Industries, Inc., P.O. Box 152, Forest City, Iowa 50436, Attention: Owner Relations Department (800-537-1885) and furnish the following information:
 - The complete serial number of the vehicle
 - Date of retail purchase
 - Selling dealer's name
 - Nature of the service problem, and a brief explanation of the steps or service the dealer has performed, and the results obtained. The customer may be directed to another dealer or service center for repairs to be completed, if such a dealer or service center is better able to complete the repair.

Winnebago Industries may, at its option, request the vehicle be returned to Forest City, Iowa for repair. If the customer refuses to allow repairs to be performed at the Forest City, Iowa facility, the warranty on that repair will be voided.

5. If after the above steps are completed and the repairs are not satisfactory, the customer may contact the Service Administration Manager of Winnebago Industries, and request a customer relations board meeting to resolve the problem. This action, however, is not mandatory.
6. Certain components are covered beyond the 12 months/15,000 miles basic warranty coverage by the individual manufacturer's warranty. Please refer to the component's information supplied in the owner's information InfoCase for any additional warranty coverage after the basic warranty has expired.

DEALER'S REPRESENTATIONS EXCLUDED

Winnebago Industries, Inc. does not undertake the responsibility to any purchaser of its products for any undertaking, representation, or warranty made by dealers selling its product beyond those herein expressed.

INSTALLATION NOT COVERED

Winnebago Industries, Inc. cannot, however, and does not accept any responsibility in connection with any of its motor homes for additional equipment or accessories installed at any dealership or other place of business, or by any other party other than Winnebago Industries, Inc. Such installation of equipment or accessories by any other party will not be covered by the terms of this warranty.

CARE AND MAINTENANCE

It is the owner's responsibility to perform the care, maintenance and proper load distribution described in the owner's manual which accompanies your motor home. Any damage which results to your vehicle as a result of your failure to perform such duties, is not covered.

Damage to appearance items such as fiberglass, metal, paint, fabrics and trim, may occur during manufacturing or transporting. Normally, any factory defect or damage is corrected at the factory. In addition, dealers are obligated to inspect each vehicle upon delivery to them and prior to delivery to you. You should also immediately inspect appearance items and advise your selling dealer of any discrepancies. Damage and normal deterioration due to use and exposure is not covered by this warranty.

CHANGES IN DESIGN

Winnebago Industries, Inc. reserves the right to make changes in design and changes or improvements upon its products without imposing any obligation upon itself to install the same upon its products theretofore manufactured.

NEW YORK:

If your motor home has been repaired three or more times for the same nonconformity, defect, or condition, or if your motor home has been out of service by reason of repair for twenty-one days, Section 198-a of the General Business Law of the State of New York requires you to provide written notice by certified mail, return receipt requested, to Winnebago Industries or its authorized dealer before making any claim under that section of the law. If you do have problems with your motor home, you should provide written notice to Winnebago Industries at the following address:

Winnebago Industries, Inc.
P.O. Box 152
Forest City, Iowa 50436
Atten: Owner Relations

CALIFORNIA:

Winnebago Industries participates in the Consumer Arbitration Program for Recreation Vehicles (CAP-RV). This third-party dispute resolution program is available, at no charge to you, to settle unresolved warranty disputes for recreational vehicles. This dispute resolution program reviews eligible product and service related complaints involving warranty covered components.

To find out more about the program, or to request an application/brochure, please call the Arbitration Administration office toll-free 800-279-5343.

The CAP-RV program operates as a certified mechanism under the review of the California Arbitration Certification Program. You must utilize the arbitration program before claiming rights conferred by 15 USC section 2310 (Uniform Commercial Code) or Civil Code section 1793.22(b) (Tanner Consumer Protection Act). You are not required to use the program if you choose to seek redress by pursuing rights and remedies not created by those laws.

SECTION 2 SAFETY & PRECAUTIONS

GENERAL WARNINGS

- Only seats equipped with seat belts are to be occupied while the vehicle is moving.
- Make sure all passengers have seat belts fastened in a low and snug position so the force exerted by the belt in a collision will be spread across the strong hip area. Pregnant women should wear a lap-shoulder belt whenever possible, with the lap belt portion worn low and snug throughout the pregnancy.
- All moveable or swiveling seats should be placed and locked in forward facing positions while the vehicle is moving.
- Never let passengers stand or kneel on seats while the vehicle is moving.
- Sleeping facilities are not to be utilized while vehicle is moving.
- Examine the escape window and be familiar with its operation.
- Inspect the fire extinguisher monthly for proper charge and operating condition. This should also be done before beginning a vacation or any extended trip.

DRIVING

- Do not attempt to adjust the driver's seat while the vehicle is moving.
- Do not adjust tilt steering in a moving vehicle.
- Do not operate the cruise control on icy or extremely wet roads, winding roads, in heavy traffic, or in any other traffic situation where a constant speed cannot be maintained.
- Use care when accelerating or decelerating on a slippery surface. Abrupt speed changes can cause skidding and loss of control.
- Driving through water deep enough to wet the brakes may affect stopping distance or cause the vehicle to pull to one side. Check brake operation in a safe area to be sure they have

not been affected. Never operate any vehicle if a difference in braking efficiency is noticeable.

- Adverse weather conditions and extremes in terrain may affect handling and/or performance of your vehicle. Refer to your chassis manual for related information.

FORMALDEHYDE INFORMATION



WARNING

Some components in this vehicle contain formaldehyde based adhesives which may release formaldehyde fumes into the air for an unknown period of time until total dissipation occurs. Individuals who are allergic to formaldehyde gas fumes may experience irritation to eyes, ears, nose and throat. Reaction in infants may be more severe. Although long range effects are not well understood, testing to date has not revealed any serious health effects in humans at the level of emission from these products.

LP GAS LEAK DETECTOR

Your coach is equipped with an LP gas leak detector which sounds an alarm if an unsafe amount of LP gas is present inside the coach. Because LP gas is heavier than air, the detector is located on a cabinet face near the floor of the coach.

See the LP Gas Leak Detector manufacturer's information in your Owner InfoCase for complete instructions.



LP Gas Leak Detector



WARNING

Never use an open flame to test for gas leaks. When testing for gas line leaks with a soapy water solution, DO NOT use a detergent containing ammonia or chlorine. These substances may generate a chemical reaction causing corrosion to gas lines, resulting in dangerous leak conditions.

Power Connection

The LP gas leak detector is powered by the coach batteries. If the auxiliary battery switch is shut off or the battery cable is disconnected from the batteries, the alarm will not work. The LP gas leak detector circuit breaker is located in the 12-volt house circuit breaker panel.

Because the LP gas leak detector is connected to the auxiliary battery, it is always drawing a small amount of current. Even though this current draw is slight, it could drain the coach battery during storage periods when the house battery will not be charged regularly by the engine or shoreline. Turn the Aux. Batt switch OFF to avoid current drain during storage periods.

Further Information

See the manufacturer's information in your Owner InfoCase for further instructions on nuisance alarms and care and testing of the LP gas leak detector.

**CARBON MONOXIDE
WARNING**



WARNING

Avoid inhaling exhaust gases, as they contain carbon monoxide, which is a colorless, odorless and poisonous gas.

The best protection against carbon monoxide entry into the vehicle body is a properly maintained engine exhaust and ventilation system. It is recommended that the exhaust system and body be inspected by a qualified motor home service center.

- Each time the vehicle is serviced for an oil change.
- Whenever a change in the sound of the exhaust system is noticed.
- Whenever the exhaust system, underbody or rear of the vehicle is damaged.

To allow proper operation of the vehicle's ventilation system, keep front ventilation inlet grill clear of snow, leaves or other obstructions at all times. **DO NOT OCCUPY A PARKED VEHICLE WITH ENGINE RUNNING FOR AN EXTENDED PERIOD.**

Do not run engine in confined areas, such as a garage, except to move vehicle into or out of area.

CARBON MONOXIDE ALARM

Your coach is equipped with a carbon monoxide (CO) alarm located on the ceiling in the bedroom area. The CO alarm is powered by a 9-volt battery and has a sensor that is designed to detect toxic carbon monoxide gas fumes resulting from incomplete combustion of fuel. It will detect CO gas from any combustion source such as the furnace, gas range/oven, water heater, refrigerator, chassis engine, and electric generator engine.

Press button to test

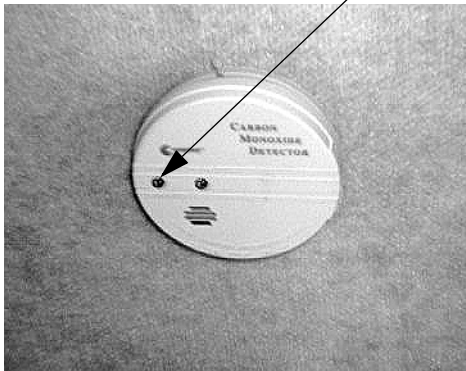

Carbon Monoxide Alarm

Further Information

Please read the information provided by the manufacturer, which is included in your Owner InfoCase. It includes information on precautions, operational testing, and battery replacement.

Press button to test

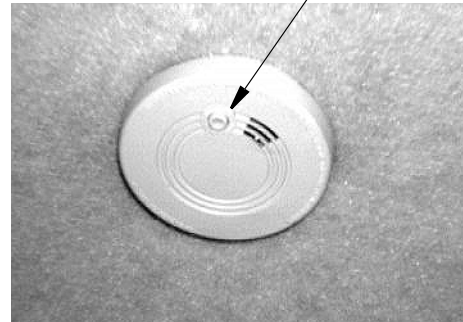

Smoke Alarm

Further Information

See the manufacturer’s information in your Owner InfoCase for further instructions on battery replacement and testing of the smoke alarm.

SMOKE ALARM

Your motor home is equipped with a smoke alarm located on the ceiling in the galley area. This alarm meets U.L. Standard 217 and NFPA Standard 74 for operation of smoke detection devices.

The following label is affixed either to the smoke alarm or on the ceiling near the smoke alarm.

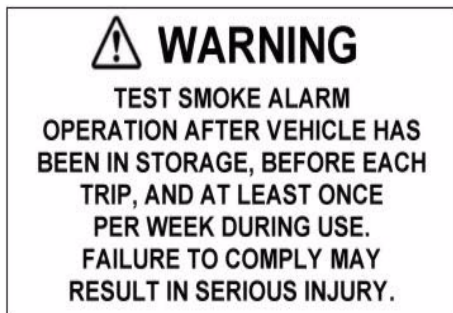

FIRE EXTINGUISHER

A dry chemical fire extinguisher is located near the main entrance door.



We recommend that you become thoroughly familiar with the operating instructions displayed on the side of the fire extinguisher or in the information supplied in your Owner InfoCase.

We also recommend that you inspect the fire extinguisher for proper charge at least once a month in accordance with National Fire Protection Association (NFPA) recommendations as stated on the label.

If the charge is insufficient, the fire extinguisher must be replaced.

 **WARNING**

Do not test the fire extinguisher by discharging it. Partial discharge can cause leakage of pressure or contents which would render the unit inoperative when needed. When using the fire extinguisher, aim the spray at the base of the fire.

 **WARNING**

This window should be kept closed while driving to avoid drawing dangerous exhaust gases into the vehicle.

EMERGENCY EXITS

 **WARNING**

Use care when exiting emergency window, as broken glass may be present in the exit area.

Escape Window

The bedroom escape window is secured by two red safety latches at the bottom of the window.

To open, lift both latches up and toward the center of the window, then push outward near the bottom of the window.



Lift latch handles upward to open.
Escape Window

**Using Slider Windows As
Emergency Exits**

Most slider windows along the side of the motor home can also be used as emergency exits, should the need arise.

To use a slider windows as an exit, first slide the window open, then slide the screen open or push the screen material out, depending on window type.

Coaches that are required to have a slider window as an alternate exit window will be marked EXIT and have a red handled latch.



Pull latch outward to slide window open

ROADSIDE EMERGENCY

Because of the size and weight of this vehicle and its tires, and the possible complications involved in tire changing, we strongly advise obtaining professional road service to change a flat tire whenever possible. However, if an emergency requires you to change the tire yourself, please exercise extreme caution and read all tire changing information in the chassis operating guide.

Never get beneath a vehicle that is held up by a jack only.

If You Get A Flat Tire

- DO NOT panic.
- Grip the steering wheel firmly and steer the vehicle as straight as possible. Avoid quick maneuvers. You may need to counter-steer to compensate for “pull” created by the failed tire.
- DO NOT stomp on the brake. This abruptly shifts the vehicle’s weight forward, making it nose-dive and pull toward the blown-out side.
- DO NOT jerk your foot off the accelerator. Just ease back on the accelerator slowly and gently to continue momentum. The deflated tire will slow the vehicle.
- If you must change lanes to get to a safe stopping place, use your signals to warn other motorists and change lanes smoothly and carefully after you are certain the lane is clear.
- Let the vehicle coast to a stop, gently steering to a safe stopping place off the traffic lanes of the road. Don’t worry about damaging the tire or wheel rim by driving on it. A tire or wheel replacement is cheaper than damaging the vehicle or injuring yourself.
- When you have come to a stop, activate your hazard flashers to warn other motorists, then exit the vehicle carefully.
- Set out flares or other warning devices.

Check your tires for proper inflation before each trip and at least once a month with an accurate tire gauge.

Recovery Towing

When calling a professional towing service, we recommend that you advise them of your coach length and approximate front axle weight listed on your Vehicle Certification Label. This will allow the towing operator to determine the proper towing equipment to use.

We recommend that you ask for an underlift (wheel lift or frame lift) type towing assembly for safe towing.

Winnebago Industries does not assume responsibility for damage incurred while towing this vehicle.

NOTE: Consult the chassis owner’s manual for any additional towing instructions or precautions provided by the chassis manufacturer.

	CAUTION
Do not lift on bumper. Damage will result to front end body parts.	

	WARNING
Stay out from beneath the motor home while it is suspended by the towing assembly unless the vehicle is adequately supported by safety stands. Do not allow passengers to occupy a towed vehicle.	

JUMP STARTING

If your coach will not start from the automotive batteries, try using the Battery Boost Switch to divert power from the coach batteries to the starter. (See Battery Boost Switch in Section 3). If you wish to try jump starting the engine using another vehicle or booster system, see your chassis owner’s manual for connecting jumper cables to the automotive electrical system.

	WARNING
Do not attempt to push-start this vehicle. Damage to the transmission or other parts of the vehicle could occur.	

ENGINE OVERHEAT

If you see or hear steam escaping from the engine compartment or have any other reason to suspect an extreme engine overheating condition, pull the vehicle over to the roadside as soon as it is safe to do so, stop the engine and get all passengers out of the vehicle.

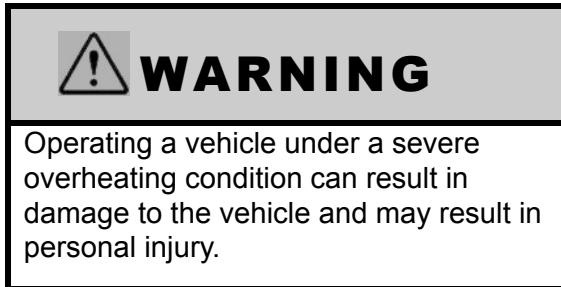

For information on what to do in case of overheating, consult your chassis operating guide.

EFFECTS OF PROLONGED OCCUPANCY

Your motor home was designed primarily for recreational use and short term occupancy. If you expect to occupy your coach for an extended period, be prepared to deal with condensation and humid conditions that may be encountered.

Humidity and Condensation

Moisture condensing on the inside of windows is a visible indication that there is too much humidity inside the coach. Excessive moisture can cause water stains or mildew which can damage interior items such as upholstery and cabinets.

When you recognize the signs of excessive moisture and condensation in your coach, you should take immediate action to minimize their affects.

You can help reduce excessive moisture inside the motor home by taking the following steps:

Ventilate with Outside Air

Partially open one or more windows and a roof vent to circulate outside air through the coach. In cold weather, this ventilation may increase use of the furnace, but it will greatly reduce the condensation inside the coach.

Minimize Moisture Released Inside the Coach

Run the range hood fan while cooking, and open a bath vent while bathing or showering to carry water vapor out of the coach. Avoid making steam from boiling water excessively or letting hot water run. Avoid bringing extra moisture into the coach by way of soaked clothing or snow on shoes. Do not hang-dry wet overcoats or clothing inside the coach.

SECTION 3 DRIVING YOUR MOTOR HOME

The information in this section refers only to features installed or adapted to the dash and driver compartment area by Winnebago Industries. It also includes passenger seating in the living area of the coach.

See your chassis owner's manual for all original chassis related controls, instrumentation, switches and other features. This includes items such as cruise control, parking brakes, gauges, wipers, lights, etc.

SEATS

The driver and co-pilot seats may be independently adjusted to suit individual preference.

The seats may be swiveled to provide easy entrance and exit. The swivel feature also allows the seats on most models to be turned toward the living area for additional seating while the unit is parked.



WARNING

Do not adjust driver's seat while vehicle is in motion.

After adjusting seat, always use body pressure to make sure slide and swivel locking mechanism have engaged.

FRONT SEATS

Manual Seat Adjustments



6-Way Power Front Seats - Optional

The power seat controls are located on the lower right hand side of the driver seat base.



Hip Area
Up/Down

Main Seat
Position
Up/Down
Fore/Aft

Knee Area
Up/Down

To Face Driver's Seat Rearward: Manual Seat

- Tilt the steering wheel all the way up and extend the telescoping column all the way out.
- Put the left armrest down.
- Swivel the seat to the right until it just contacts the steering wheel, then slide the seat forward all the way.
- Lift the recliner lever and let the seat back tilt forward to clear the steering wheel.
- Swivel the seat the rest of the way to face the living area.
- Position the tilt wheel down and the column all the way in to provide maximum clearance to recline the seat.

- Reverse the procedure to face the seat forward.

Power Seat

- Tilt the steering wheel all the way up and put the left armrest down.
- Move the seat rearward fully and then forward a few inches.
- Swivel the seat to the right until it just contacts the steering wheel, then move the seat forward all the way to clear the steering wheel.
- Swivel the seat the rest of the way to face the living area.
- Collapse the steering column all the way and position the tilt wheel down to provide maximum clearance to recline the seat.
- Reverse the procedure to face the seat forward.

Armrest Adjustment

The armrests may be swung upward out of the way for easy exit or access to the front seats. A roller on the underside of the front of the armrest also lets you adjust the resting angle for personal comfort, whether the seat is upright or reclined.



SEAT BELTS

Seats intended for occupancy while the vehicle is in motion are equipped with seat belts for the protection of the driver and passengers.

Lap Belts

The lap belts must be worn as low as possible and fit snugly across the hip area. Always sit erect and well back into the seat. To gain full

protection of the safety belt, never let more than one person use the same safety belt at any one time, and do not let the safety belts become damaged by pinching them in the doors or in the seat mechanism. After any serious accident, any seat belts which were in use at the time should be replaced.

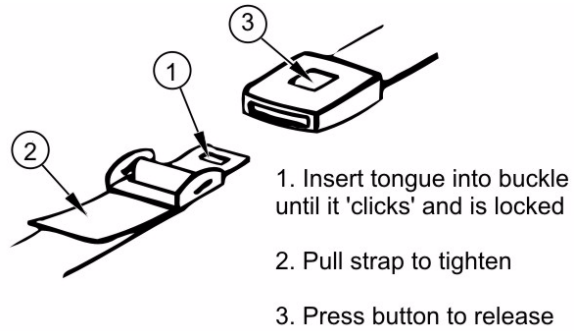

Adjustment: To lengthen belt, turn tongue at a right angle to belt and pull to desired length. To shorten, pull loose end of belt.

To Fasten: Be sure belt is not twisted. Grasp each part of the belt assembly and push tongue into buckle. Adjust to a snug fit by pulling the loose end away from the tongue.

To Release: Press button in center of buckle and slide tongue out of buckle.

 WARNING
Snug and low belt positions are essential. This will ensure that the force exerted by the lap belt in a collision is spread over the strong hip area and not across the abdomen, which could result in serious injury.
Only seats equipped with seat belts are to be occupied while vehicle is in motion.

Lap-Shoulder Belts

Fastening: Hold the belt just behind the tongue using the hand nearest to the door. Next, bring the belt across the body and insert the tongue into the buckle until the latch engages.

Unfastening: Press the release button in the buckle. Hold onto the tongue when you release it from the buckle to keep it from retracting too rapidly.

When the lap-shoulder belt is in use, the lap belt must ride low across the hip area and the shoulder belt must ride diagonally over the shoulder toward the buckle.

The shoulder belt is designed to lock only during a sudden stop, sudden body movement or a collision. At all other times it will move freely with the occupant.

 WARNING
<p>Never wear the shoulder belt in any position other than as stated above. Failure to do so could increase the chance or extent of injury in a collision.</p>

Seat Belt Care and Cleaning

- Be careful not to damage the belt webbing and hardware. Take care not to pinch them in the seat or doors.
- Inspect the belts and hardware periodically. Check for cuts, frays, and loose parts. Damaged parts should be replaced. Do not remove or modify the belt system.
- Keep belts clean and dry. If the belts need cleaning, use only a mild soap and water solution. Do not use hot water. Do not use abrasive cleaners, bleach or dyes. These products may weaken the belts.
- Replace any belt assembly that was used during a severe impact. Replace the complete assembly even if damage is not apparent.

CHILD RESTRAINTS

A properly installed and secured child restraint system can help reduce the chance or severity of personal injury to a child in an accident or during a sudden maneuver. Children may be injured in an accident if they are seated in a child restraint system which is not properly secured.

A child restraint system is designed to be secured in a vehicle seat by a lap belt or the lap belt portion of a lap-shoulder belt. According to accident statistics, children are also safer when properly restrained in rear seating positions than in front seating positions.

When purchasing a child restraint system:

1. Look for the label certifying that it meets all applicable safety standards.
2. Make sure that it will attach to your vehicle and restrain your child securely and conveniently so that you are able to install it correctly each time it is used.
3. Be certain that it is appropriate for the child's height, weight and development. The instructions and/or the regulation label attached to the restraint typically provides this information.
4. Review the instructions for installation and use of the restraint. Be sure that you understand them fully and can install the restraint properly and safely in your vehicle.

Tether Anchor Loop

If your coach has a dinette, a child seat tether anchor loop is located in the floor of the coach directly behind the forward facing dinette seat. The dinette table must be in the **lowered** position when a child seat is in use.

POWER DOOR LOCKS

The power door locks control the main side entrance door and storage compartment locks. The switches are located on the entry switch panel.

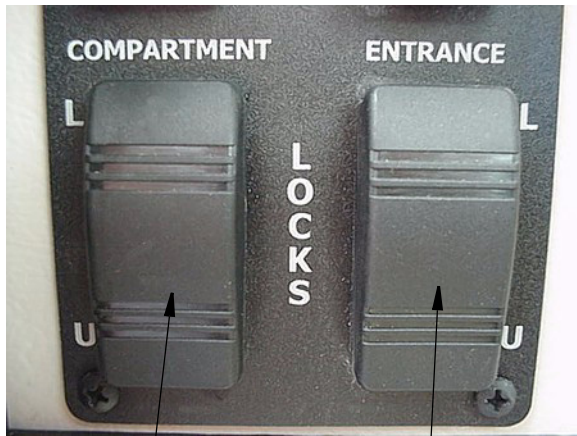

Storage Compartment Door Locks Entrance Door Locks

Keyless Remote Entry System

The keyless entry is a remote control power door lock system. This feature allows you to unlock or lock your entrance door and cargo doors from outside the coach without using a key.

Lock: When you leave the coach, simply press the “lock” button on the remote transmitter attached to your key ring. The entrance door will lock. Your parking lights will flash once to tell you that the door has locked.

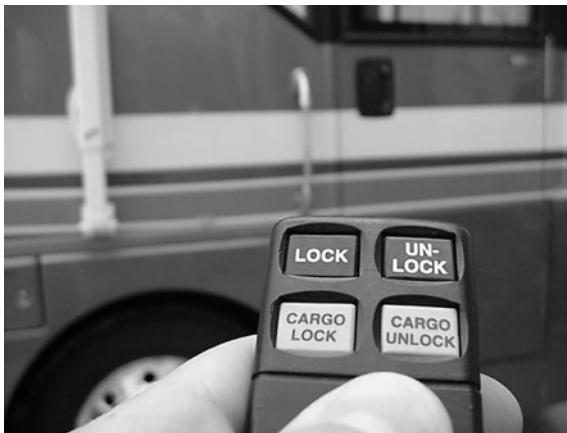

Keyless Remote Unit

Unlock: When you return to the coach, press the “Unlock” button on the transmitter and your parking lights will flash twice to tell you that the door has unlocked. The porch light and passenger map light will also come on for 20 seconds to light your way to the coach.

NOTE: Keys should always be removed when leaving the vehicle. Since doors can be locked without keys, make sure they have been removed from the ignition before locking the coach.

POWER ELECTRIC MIRRORS

The electric mirrors are adjusted using a multi-directional switch located on the driver’s side armrest.



Power Mirror Controls

Select the mirror to be adjusted by pushing the switch in the middle of the control to the right or left. Then press the arrow buttons as necessary to obtain the best view.

Press to move mirror in indicated direction

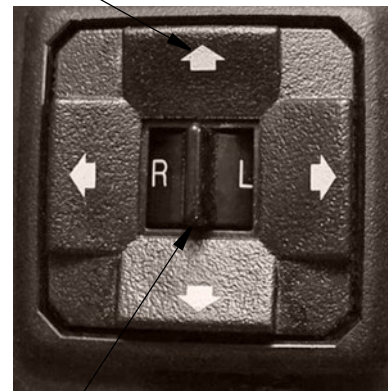

Move L or R to select mirror, or center for “neutral”.

When mirrors are adjusted to preference, place the selector switch back in the middle position to cancel power to the buttons. This prevents accidental misadjustment of mirror settings.

The mirrors also contain heating elements to defog or de-ice the mirror glass during cold weather operation. An ON-OFF switch for the mirror heaters is located near the remote mirror controls.

If you cannot adjust the mirror properly using the control switch, the mirror may need a coarse adjustment by repositioning the mirror arm and/or rotating the mirror head.



Mirror Arm
Unscrew protective cap and loosen Allen head set screw to pivot mirror head.



Allen Head Set Screw*

*Set screws may be located on the opposite side of the mirror arm. Passenger side mirror is similar



Remove (unscrew) caps to access set screws*

Mirror Arm Mount Base
Unscrew protective caps and loosen Allen head set screws to pivot mirror arm.

If mirror arm will not pivot with set screws loosened, you may also need to loosen the mirror arm pivot bolt on the underside of the mounting base shown. Be sure to tighten this bolt when adjustment is done.



Carefully pry out plug on underside of mirror base to access pivot bolt.



Mirror Arm Pivot Bolt
on underside of mounting base.
(Shown with access plug removed.)

REARVIEW MONITOR SYSTEM

The rearview camera monitor system lets you see what's directly behind your coach for maneuvering assistance and safety.

A microphone is built into the camera to let you hear warning sounds or verbal directions from an assistant.



Operating Instructions

See the rearview monitor manufacturer's operating information in your Owner InfoCase.

ELECTRONIC COMPASS AND OUTSIDE THERMOMETER



See the compass manufacturer's guide in your Owner InfoCase for operating instructions, calibration, specifications and other information.

POWER SUNVISORS

-Optional

The powered sunvisors are controlled by switches on the driver and passenger armrest panels. The driver side contains switches for both sides to allow driver control. The passenger side has a switch only for the passenger side visor.

Press and hold DOWN side of the switch to extend, then release at the desired position. Press and hold UP side of the switch to retract the visor.

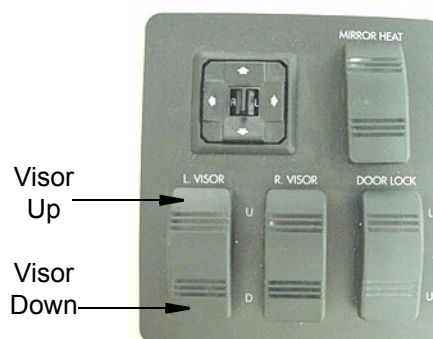

NOTE: Do not position visors where they will impair the driver's forward vision or exterior mirror view.

VEHICLE INFORMATION CENTER

The Vehicle Info Center is an interactive display screen that provides information about your vehicle. It is similar to a 'trip computer'

except that it provides additional vehicle operating conditions, performance data and diagnostic information.



Vehicle Information Center



T/Toggle: Cycles through the screens of a menu.

H/Home: Takes you back to the previous menu page.

Up Arrow: Scroll menu up. Highlights the next line up on the menu.

E/Enter: Enter the selected menu line.

Down Arrow: Scroll menu down. Highlights the next line down on the menu.

Favorite (Red Button): Returns to Start-up page.

See your chassis operating guide for complete instructions on using this feature.

PARKING BRAKES

The parking brakes are applied by pulling outward on the large yellow knob on the dash to the left of the steering column. Push the knob in to release the brakes.



Parking Brake Knob

Use the parking brakes whenever the vehicle is parked. Never try to drive the vehicle with the park brake applied. This can cause excessive wear on the brakes and may damage the transmission.

NOTE: It is normal to hear an occasional burst of air pressure from the rear of the vehicle. This is an automatic moisture purging feature of the air brake system. See the Brakes section of your chassis manual for instructions on periodic draining of brake air tank.

EXHAUST RESTRICTION BRAKING SYSTEM

To Use the Exhaust Brake

The exhaust brake activation switch is located on the lower left side of the dash. Press and release the ON side of the switch to activate the exhaust brake system. The exhaust brake will operate whenever you let up on the throttle pedal while the switch is ON.

Press and release the OFF side of the switch to deactivate the exhaust brake system and return to chassis brakes alone.



How It Works

The exhaust brake generates “braking” power by controlled restriction of the engine’s exhaust gas flow.

When the exhaust brake is activated, a valve closes off the engine’s exhaust causing the exhaust back pressure to increase, which causes the vehicle to slow down.

The increased back pressure would normally stop the engine except the forward momentum of the vehicle keeps the drivetrain and the engine turning.

This controlled back pressure helps to regulate a vehicle’s downhill speed, such as on mountainous or hilly roads. It also provides “braking” on level or near-level roads.



WARNING

Do not activate the engine exhaust braking system while on icy or extremely wet roads or in any other situation where abrupt deceleration could cause skidding or loss of vehicle control.

MAP LIGHT SWITCH

Turn the map light on using the Panel Light brightness thumbwheel control.

Roll it up towards “Cargo/Dome” until you feel it click into the map light ‘on’ position.



See your chassis manual for further information on this switch.

HAZARD WARNING LIGHTS

The hazard warning flasher switch is located on the underside of the steering column near the turn signal lever. Pull the switch button outward from the column to activate the flashers. To cancel flashers, push the switch button inward toward the column.

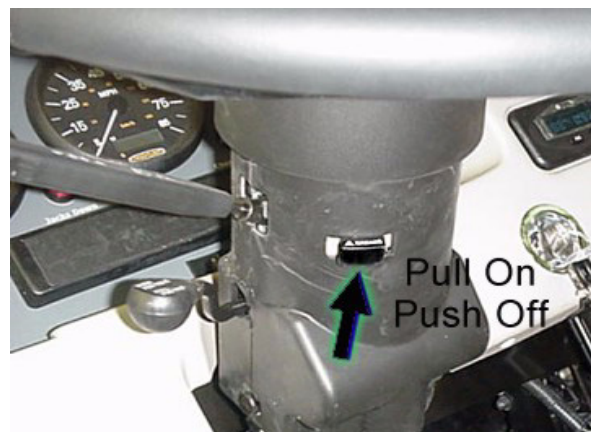

SIGNAL LEVER/HEADLIGHT HI/LO BEAM

The signal lever controls the turn signals and high/low beam changing.



Turn Signals/Hi-Lo Beams

Move multi-function lever upward for right turn signal and downward for left turn signal.

Pull end of handle toward you to switch high beam to low, or low beam to high.

STEERING COLUMN TILT/TELESCOPE

The tilt/telescoping adjustment lever is located on the left side of the steering column.

To Adjust Tilt Wheel

Pull the lever toward you and tilt the steering wheel to the desired angle, then release the lever.

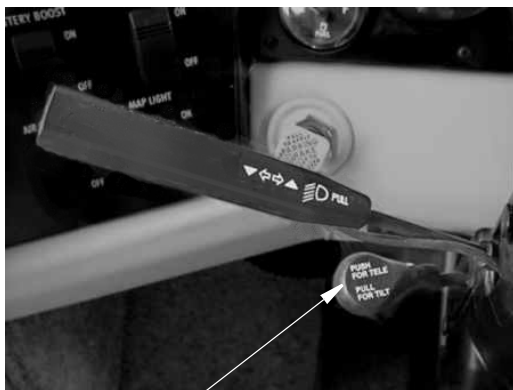

Pull to Tilt - Push to Telescope

To Adjust Telescoping Column

Push the lever toward the dash. Push or pull the steering wheel to slide the steering column in or out to the desired length. Release the lever to lock the column into position.

 **WARNING**

Do not adjust the steering column or tilt wheel while the vehicle is in motion. This could cause a loss of vehicle control.

AUX START SWITCH

This switch can be used to provide emergency starting power from the motor home auxiliary battery if the automotive battery is discharged.



Aux. Start Switch

If engine battery is discharged, press and hold while turning ignition key for emergency starting power.

NOTE: The Aux Battery switch must be ON and house batteries sufficiently charged for this feature to work.

AUTO AIR CONDITIONER/ HEATER

Controls for the air conditioner, heater, defroster and vent are all combined into one control panel.

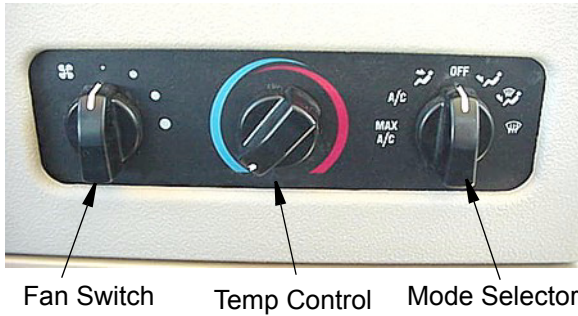

Further Information

See the manufacturer's information in your Owner InfoCase for specific operating instructions and other information.

NOTE: The dash air conditioner is not designed to cool the entire interior of the coach, but is intended to cool the cab area only.

AUX FAN SWITCH

The optional two-speed auxiliary fans are intended to assist the automotive windshield defroster system in clearing fog and frost in cold weather or humid conditions.

The middle position on the switch is OFF.



IN-DASH RADIO

The dash radio in your coach can receive AM/FM stereo and Weather band stations. It also has a compact disc (CD) player for your listening enjoyment through quality high-output speakers located in several areas of the coach.



Please refer to the radio manufacturer's operating guide in your Owner InfoCase for detailed instructions on programming preset station buttons and using this full-featured radio/audio system.

Radio Remote Controls

A steering wheel mounted remote control for the radio lets you change radio stations or CD selections without taking your eyes off the road or hands off the wheel. See the radio owners guide in your Owner InfoCase for remote control instructions.



An additional hand-held remote allows these same conveniences for the passenger. The hand-held radio remote is in your owner InfoCase.

Radio Power Switch

The radio power switch lets you connect the dash radio to the coach batteries with the ignition

switch turned off for listening while parked. This prevents accidental draining of the chassis (starting) battery with prolonged use of the radio.



Radio Power Switch

FUEL SELECTION

Refer to your chassis owner's manual for the manufacturer's recommendations on proper fuel selection.

Winter Fuel Waxing and Anti-Gel Additives

In sub-freezing temperatures, #2 diesel fuel can form small wax crystals that become trapped in the fuel filter and block the fuel flow to the engine, causing it to stall out. At sub-zero temperatures, the fuel can congeal and turn "slushy". If this happens, the only remedy is to have the vehicle towed into a heated facility to allow the fuel to warm up and become fully liquid again.

During winter time, most truck stops and reputable filling stations have winter blend diesel fuels available that are less susceptible to waxing.

There are also commercially available products, typically called anti-gel additives, to add to diesel fuel while filling the tank to inhibit wax formation in freezing temperatures.

Consult your chassis guide or diesel engine guide for more information on fuel requirements and additives.

FILLING THE FUEL TANK

Diesel fuel, especially #2 grade, can foam up while being pumped into the tank. Sometimes this foam can cause the pump nozzle to shut off before the tank is actually full. Allow the foam to settle then resume filling at a slower flow rate until the tank is full.

STARTING AND STOPPING ENGINE

Refer to your chassis operating guide for the manufacturer's recommendations on starting and stopping the engine.

See also "Engine Block Heater" in this section.

Do not attempt to start the vehicle by hot-wiring.

Idling Diesel Engine

CAUTION

Do not operate engine at low idle for long periods with engine coolant temperature below the minimum specification in Maintenance Specifications. This can result in the following:

- Fuel Dilution of the lubricating oil
- Carbon build up in the cylinder
- Cylinder head valve sticking

Reduced performance

WARNING DO NOT USE ETHER OR STARTING FLUID

INTAKE MANIFOLD HEATER
MAY CAUSE EXPLOSION
AND SEVERE INJURY.

ENGINE BLOCK HEATER

Your coach is equipped with an engine coolant heater to assist starting in freezing temperatures. The power cord is located in the rear cargo compartment on the driver side of the coach. When plugged into the receptacle, the heater is connected to both the shoreline and the auxiliary generator, so a separate extension cord is not needed. The power switch is a standard household light switch located above the OnePlace Systems Monitor Panel.



Diesel Engine Heater Switch

REMEMBER! Turn the engine heater switch off after starting the engine. The heater will keep operating for as long as it is supplied with electricity. If the switch is left on, the engine heater will come on each time you hook up the shoreline cord or start the generator.

ENGINE ACCESS GRILLE – REAR

The diesel engine is located behind the grille panel at the rear of the vehicle.

Unlock the latches near the ends of the grille panel and swing it upward.

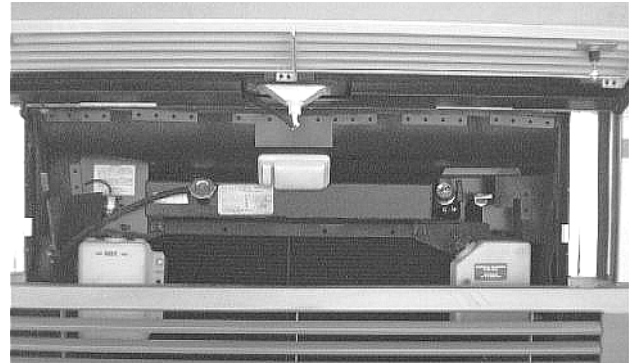

With the grille panel open, you can access the following service points:

- Engine Oil Dipstick
- Engine Oil Fill Cap
- Power Steering Reservoir
- Radiator Cap
- Engine Coolant Overflow Bottle
- Transmission Dipstick/Fill Tube
- Air Filter Restriction Indicator
- Engine Diagnostic Connector
- Chassis Battery Cutoff Switch
- Air Manifold w/Air Hose Connector

ENGINE TOP ACCESS COVERS – REAR

These covers are only removed if a complete view of the engine is needed for inspection, or for replacement or adjustment of upper engine parts.

The engine top covers are located beneath the rear bed and wardrobe, depending on model.

⚠ CAUTION

Please take precautions to protect carpet and interior furnishings when removing engine covers. The undersides of the engine covers could contain deposits of oil and fuel or other engine fluids and substances that could damage fabrics and interior furnishings.

**Models with ‘North-South’ Beds
(Lengthwise to Coach)**

- Remove the mattress from the bed and set aside in another area of the coach.
- Remove the screws that fasten the foot end of the bed board down to the bed base. (Note: If bed is designed for storage below bed board, these screws will not be present.)
- Lift the hinged bed board upward against wall.

NOTE: Support the bed board with a suitable prop item (e.g. 2x4 board or thick metal pipe) while removing covers and accessing engine.

- Remove fasteners from metal engine covers and set covers aside.

**Models with ‘East-West’ Beds
(Crosswise to Coach)**

- Remove the mattress from the bed and set aside in another area of the coach.
- Remove the screws that fasten the foot end of the bed board down to the bed base. (Note: If bed is designed for storage below bed board, these screws will not be present.)
- Lift the hinged bed board upward against wall.

NOTE: Support the bed board with a suitable prop item (e.g. 2x4 board or thick metal pipe) while removing covers and accessing engine.

- Remove the screws that fasten the wardrobe steps beside the bed, then remove the step boards and set aside.
- Lift the false floor panels from the bottom of the wardrobe and set aside.
- Remove fasteners from metal engine covers and set covers aside.

FUEL/WATER SEPARATOR

Diesel fuel often contains small quantities of water which can damage the engine if not filtered out. The fuel/water separator traps this water and prevents it from reaching the engine. The harmful water deposits must be drained from the separator canister during normal periodic service and maintenance to keep the fuel filtration system working effectively.

The fuel/water separator is located in the rear engine compartment.

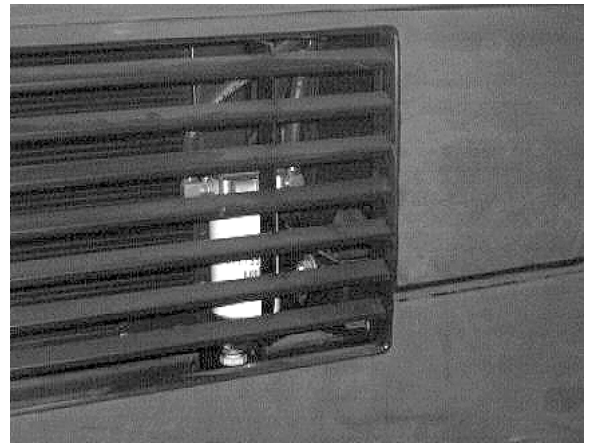

Place an appropriate container beneath the outlet and open the water release valve several turns. Drain any water deposits from the canister until clean diesel fuel flows from the valve. Close valve by hand. Do not over tighten.

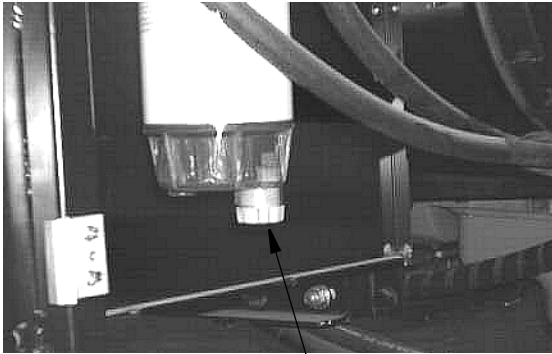

Fuel/Water Drain Valve

Dispose of the drained liquid in an environmentally responsible manner, such as taking to a waste oil disposal center.

ENGINE COOLING SYSTEM

Refer to your chassis operating guide and diesel engine manual for information and precautions on filling, servicing and checking the fluid level.

Do not remove the radiator cap while engine and radiator are still hot. Always check coolant level visually at the see-through coolant reservoir.

NOTE: Your chassis engine cooling system is filled with special extended-life coolant that is not the same as common anti-freeze available at retail outlets.

The coolant system MUST be refilled or topped up with the same type of coolant as equipped to maintain the special long-life properties.



CAUTION

When refilling the coolant system of a vehicle equipped with a rear auxiliary automotive heater and motoraid water heater, be sure to allow for additional coolant capacity of the heater and its supply and return hoses.

CHASSIS BATTERY CUTOFF SWITCH

The battery cutoff switch disconnects chassis electrical loads from the chassis (starting) batteries to avoid discharge by direct systems such as engine computers, clock chips, sensors, etc. This feature is intended to conserve battery charge when the vehicle is not in use.

Note: The slideout room mechanisms are still operable when this switch is turned off so rooms may be extended or retracted if necessary.



Turn the knob to the positions indicated (OFF or ON) to disconnect or reconnect the chassis batteries.

AUTOMOTIVE 12-VOLT FUSES AND CIRCUIT BREAKERS

The automotive fuses and breakers are conveniently located behind the 'hood' panel.

The circuit breakers will pop outward if they are tripped. Simply push in to reset.

Always replace plug-in type fuses with those of the same amperage size.

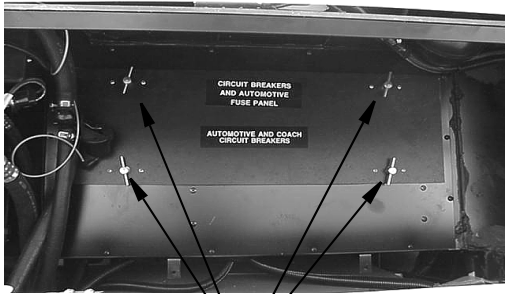

Twist Locks to Remove Cover

Automotive Fuse/Breaker
(Behind "Hood" Panel)

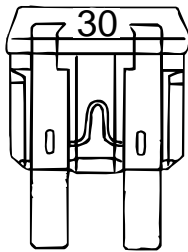

Good Fuse

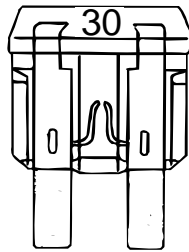

Bad Fuse

WINDSHIELD WASHERS AND WIPERS

The windshield washer fluid reservoir is located in the front of the coach at the right hand side behind the 'hood' panel. A long-necked funnel may be required for filling. We recommend using commercially available premixed solutions for best results. Do not use water in freezing temperatures because the washer pump could become damaged.



Windshield Washer Reservoir
behind front "hood" panel.

TIRES

Improper tire pressure can result in tire overloading and abnormal wear and also affects handling, ride characteristics and fuel economy.

Do not mix different construction types of tires on the vehicle such as radial, bias or belted tires, as vehicle handling may be affected. Replace tires with exact size, type and load range.

 **WARNING**

Make sure all replacement tires are of the same size and ply rating as those installed as original equipment.

See your Vehicle Certification Label for tire information.

SUSPENSION ALIGNMENT AND TIRE BALANCE

The front suspension and steering system of this vehicle was factory aligned using highly accurate equipment prior to delivery to the dealership. However, we recommend that you have alignment checked and adjusted after you have fully loaded the motor home according to

your personal needs. Thereafter, the alignment should be periodically inspected to help prevent uneven tire wear.

Any excessive or abnormal tire wear may indicate worn or misaligned suspension or steering, unbalanced tire or other tire/suspension problem.

Alignment can be affected by worn steering/suspension parts or by incidents which happen during driving, such as hitting a curb, pothole or railroad track, etc. Improper alignment can cause tires to roll at an angle and wear unevenly. It may also cause the vehicle to “pull” to the right or left. Have your dealer inspect your vehicle’s suspension and steering components periodically for misalignment or wear.

Out-of-balance tires will not roll smoothly and can lead to vibrations and uneven tread wear such as cupping and flat spots. Tires may need to be balanced if uneven wear is detected or if ride comfort decreases noticeably.

See your chassis operating guide for further information.

LIGHTS

All exterior lights should be checked for proper operation each time the vehicle is prepared for a trip. Any bulbs which fail to light should be checked and replaced, when necessary, with a new bulb of the same size. A failure of more than one light, such as both taillights not operating, may indicate a burned out fuse. Check fuse and replace with one of the same rating when necessary. If a fuse is not the cause of the problem, the wiring system should be checked immediately by an authorized service center.

Refer to your chassis operating guide for further information.

LOADING THE VEHICLE

NOTE: Your motor home’s load capacity is designated by weight, not by volume, so you cannot necessarily use all available space when loading your motor home.

- Store or secure all loose items inside the motor home before traveling. Possible overlooked items such as canned goods or small appliances on the countertop, cooking pans on the range, or free-standing furniture items can become dangerous projectiles during a sudden stop or evasive maneuver.
- Be aware of GVWR, GAWR and individual load limit on each tire or set of duals.

When loading the vehicle, distribute the cargo load equally so that you do not exceed either the Front or Rear Gross Axle Weight Rating (GAWR) or the Gross Vehicle Weight Rating (GVWR). The Gross Axle Weight Rating (GAWR) means the weight value specified by the chassis manufacturer as the load carrying capacity of a single axle system as measured at the tire-to-ground interfaces. This is the total weight a given axle is capable of carrying. Each axle has its own rating.

Have your vehicle weighed to determine the proper load distribution for your vehicle. Also distribute cargo side-to-side so the weight on each tire or dual set does not exceed one half of the GAWR for either axle.

For example, if the Front GAWR is 6,000 lbs., there should be no more than 3,000 lbs. on each tire. (If the left side weighs 3,100 lbs. and the right side weighs 2,700 lbs., at least 100 lbs. of the load must be shifted from the left side to the right side.) The GVWR is listed on the Vehicle Certification Label. (See sample in Introduction Section).

The GCWR (Gross Combination Weight Rating) means the maximum allowable loaded weight of this motor home and any towed trailer or towed vehicle.

NOTE: We recommend that you dump all holding tanks before traveling to avoid carrying unnecessary weight.

 CAUTION
<p>The weight of the loaded vehicle (including options, attachments, passengers, water, fuel, luggage and all other cargo) must not exceed the GVWR or GAWR of either axle.</p>

ROOF LOADING

The roof is capable of carrying up to 10 pounds per square foot to a maximum of 100 pounds while the vehicle is in motion.

When the vehicle is stationary, a cargo load of 100 pounds plus the weight of a 225 pound person to load the cargo or to conduct inspection and maintenance is permissible.

Weight added to both the roof and the trailer hitch contribute to the gross vehicle weight, which must not exceed the vehicle’s GVWR.

WEIGHING YOUR LOADED VEHICLE

To check the weight of your fully loaded coach, locate a commercial weighing scale that is capable of weighing large trucks.

Loading

Load your vehicle completely as if you were going on a long trip, with everything you would carry, including food, clothing, bedding, lawn chairs, etc., a full fuel tank, full LP tank, and a partial tank of fresh water - but empty holding tanks.

Finding a Scale

In urban areas, the most common places to find a public access scale are commercial truck stops. In rural areas, most grain storage elevators have scales available. Most scales charge a nominal fee for weighing a vehicle.

Weighing

There is typically a scale operator to direct you but the basic routine is to take three separate weights - front axle, whole vehicle, and rear axle. You will first drive only your front wheels onto the scale pad, then drive ahead so that the whole vehicle is on the scale, then finally pull off until just the rear wheels are on the pad.



Front Axle Only



Both Front and Rear Axles



Rear Axle Only

You will receive a weight ‘ticket’ that states your current Front Axle Weight, Rear Axle Weight and total Vehicle Weight. You can compare these weights to the gross weight ratings listed on your Vehicle Certification Label to use as a guideline for future loading limits and weight distribution.

The weight of the vehicle must not exceed the Gross Vehicle Weight Rating (GVWR) specified on the Vehicle Certification Label. The front and

rear axle weight also should not exceed the corresponding Axle Weight Rating specified on the Vehicle Certification Label.

Corner Weighing (Side-to-Side)

Weighing each corner of the coach separately (single L/R front wheels or L/R rear dual sets) is an accurate method to determine how to distribute your cargo to avoid overloading, especially on tires.

To determine the weight distribution on each tire or dual set, you will need to find a scale capable weighing side-to-side, or all four ‘corners’ of the vehicle, separately. A truck scale may be used if the ground is level with the scale surface and the scale has clearance to drive one side of the coach onto the scale as shown below.

Drive the coach on the level area next to the scale and straddle the scale so that only one side of the coach will be on the scale pad. Pull only the front wheel onto the pad as shown.



Weighing Left Front ‘Corner’

When the front wheel has been weighed, pull the coach straight ahead until only the rear wheel/dual set is on the scale pad as shown.



Weighing Left Rear ‘Corner’

After the rear wheel set has been weighed, turn the coach around and repeat this process for the other side.

The load on each wheel or dual-wheel set should not exceed one-half of the corresponding GAWR. For example, if the GAWR for the rear

axle is 12,000 lbs., then the load on each rear dual set (left rear duals or right rear duals) should not exceed 6,000 lbs.

Tires must be filled to the recommended air pressure for the highest loaded tire set on that axle. For example, on the rear axle, if the left side weighs more than the right, fill the left tires to the pressure required for that weight, then fill the right tires to the same pressure as the left ones.

If your actual weight is considerably less than GAWR, you may be able to lower your tire pressure. See a tire dealer for a load/pressure chart.

NOTE: The Hitch Load from a Towed Vehicle or carrier box must also be counted on the Rear GAWR and subtracted from the rear axle cargo capacity. If you tow other than a light trailer or a vehicle by means of a tow bar, you should have your trailer coupled when weighing your motor home.

Be aware that hitch load can affect handling characteristics. The more weight on the hitch, the lighter the front end will feel at the steering wheel.

CAR OR TRAILER TOWING

Hitch pulling capacity: 5,000 lbs. max.

Tongue weight: 350 lbs. max.

The factory installed towing hitch on this coach is capable of pulling 5,000 lbs. load (max.); however the vertical (tongue) weight may vary according to chassis and model combinations. Do not exceed either the GVWR, the rear axle GAWR, or the chassis GCWR by the combined loaded weight of the coach and the towed vehicle. *See preceding items “Loading the Vehicle” and “Weighing Your Loaded Vehicle” for explanation of weight ratings.*

Because of individual vehicle use and loading habits, we recommend weighing the vehicle while fully loaded to avoid exceeding any of the

listed Gross Weight Ratings. See “Vehicle Certification Label” in the Introduction Section for information on gross weight ratings.

Towing will affect vehicle handling, durability and fuel economy. Exceeding any of the listed Gross Weight Ratings will result in unacceptable overall vehicle performance. Maximum safety and satisfaction when towing depends on proper use of correct equipment. Select a drawbar that mates properly with the towing hitch receiver and provides proper alignment to the vehicle tow bar. The tongue of the tow bar must be as close as possible to parallel with the ground when attached to the hitch ball.

Installation of a proper trailer brake system is recommended. Check state regulations on trailer weight and trailer brake requirements to be sure you select the right equipment before towing.

NOTE: If you tow a car or trailer that weighs over 1,000 lbs., it may need to be equipped with automatically activated brakes. Check your state laws.

Before descending a steep or long grade when towing a trailer, reduce speed and shift into a lower gear to control vehicle speed. Avoid prolonged or frequent application of brakes which could cause overheating and brake failure.

 WARNING
<p>For safe towing and vehicle handling, maintain proper trailer weight distribution.</p> <p>The total weight of the motor home and the vehicle towed must not exceed the Gross Combined Vehicle Weight rating.</p>

 CAUTION
<p>Exceeding any of the recommended gross vehicle weight ratings may result in vehicle damage.</p> <p>Do not install a frame equalizing type hitch on your vehicle.</p>

Towing Package Fuses

The fuses for the chassis supplied towing package are located on a fuse block behind a close-out panel in the utility compartment on the left side of the coach as shown in the following photo.



Chassis Fuses and Relays behind close-out panel in Utility Compartment

Remove the close-out panel screws to access the chassis fuse blocks.

TRAILER WIRING CONNECTOR

Your coach is pre-wired for trailer or car towing lights with a 7-pin socket on the rear bumper. The connector plug is supplied in the coach parts package provided to you by your dealer when you took delivery of the vehicle.

The diagram shows proper connection of trailer or tow vehicle wiring to the coach light system. We recommend connections be made by a qualified auto electrical technician to avoid ‘shorts’ or other malfunctions.

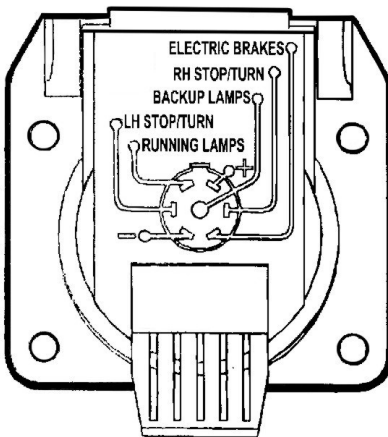

TOWING GUIDELINES

Gross Vehicle Weight Rating (GVWR):

This is the maximum allowable weight of the fully loaded vehicle. Included are fuel, water, LP, passengers, cargo, tools, and optional equipment installed by the motor home manufacturer, dealer, or owner. This value is found on the Vehicle Certification Label.

Gross Axle Weight Rating (GAWR):

This is the total weight a given axle is capable of carrying, measured at the ground. Each axle has its own rating. These values are also found on the Vehicle Certification Label: front, rear, and tag, if applicable.

Gross Combination Weight Rating (GCWR):

This is the maximum allowable weight of the motor home and loaded trailer, including the items noted in GVWR above. The “trailer” can be an actual trailer, a vehicle towed on a towing dolly, or a vehicle towed by means of a towing bar. GCWR is typically specified based on durability and performance of the tow vehicle drivetrain: engine cooling systems, transmission, drive line, drive axle, and others. The tow vehicle brakes may be rated for operation at GVWR, not GCWR.

MOUNTAIN DRIVING

Special techniques must be used when driving in mountainous or hilly country.

Climbing A Hill

The transmission will automatically downshift as needed to climb most hills. If the hill is long or very steep, however, you may need to manually shift to a lower gear to keep the transmission from repeatedly upshifting and downshifting. Select the lowest adequate gear range for the duration of the incline. See your chassis owner’s manual for specific information.



CAUTION

Observe the engine temperature gauge more frequently than normal. If overheating occurs, pull off to the side of the road and allow the engine to thoroughly cool before refilling the radiator and restarting the engine.

Descending A Hill

When going down a long grade, you may need to manually shift to a lower gear rather than keeping your foot on the brake pedal. A lower gear will allow the engine to provide a degree of braking action. Holding your foot on the brake pedal for an extended period may cause brakes to

overheat, which could cause you to lose control of the vehicle. See your chassis owner's manual for specific information.

TOOL AND LADDER STORAGE

The roof ladder extension and various supplied tools are stored in clips on the walls of one or two of the exterior storage compartments. Actual locations depend on storage compartment configuration of your model. The following photos show typical arrangements.



Awning Tool Tire Tools Air Hose

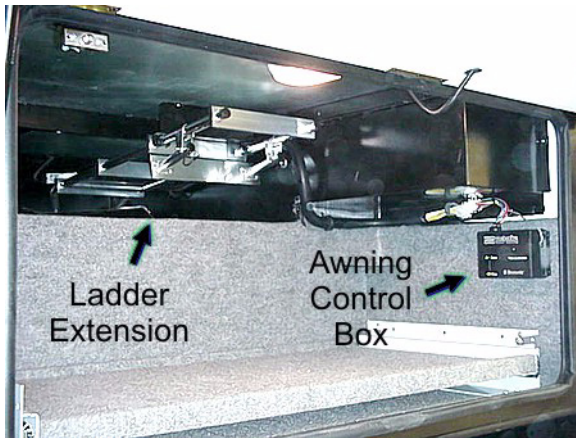

Ladder Extension

To use the ladder extension:

- Remove extension from storage clips in cargo compartment.
- Unfold the bumper support and pin into place as indicated on the following photo.
- Hold the ladder extension horizontally with the bumper support pointing downward.

- Slide the open ends of the C-shaped brackets over the lowest ladder rung as shown in the photo.



- Lower the extension into place and pull downward to 'seat' the C-brackets onto the ladder rung.



C-Brackets Bumper Support

Ladder Extension (typical)

- The ladder is now ready to use.
- Reverse steps to remove and store.

STORAGE COMPARTMENT DOORS

The high-density gaskets used on the exterior storage compartments are designed to provide a more positive seal against dust and weather. Sometimes this seal firmness can inhibit complete latching of the compartment doors if they are simply ‘dropped shut’ or closing force is applied only to the center of the door.

To ensure that exterior storage compartment doors have latched properly, press firmly on the bottom edges of the doors with the palms of your hands. If the door is ajar you will hear and feel a loud ‘click’ when the latches engage properly.

AIR HOSE CONNECTOR

For convenience, your coach is equipped with a quick-connect air coupler to which you can connect an air hose for inflating tires or sports and camping equipment if needed.

NOTE: Air hose and inflation or blowing attachments are not supplied and must be obtained separately.

The quick-connect coupler is located behind the hood panel at the front end of the vehicle. Instructions for connection and disconnection are shown on the label at the coupler.



Quick-connect air coupler and air pressure gauge at front end of coach

The air is supplied by the chassis air brake/suspension system air tank. The pressure gauge near the quick connector indicates air pressure available for use.

When the air pressure is less than what you need to inflate an item, you must start the coach engine to run the system air compressor to refill the tank.

SECTION 4 APPLIANCES & SYSTEMS

The appliances installed in your motor home are manufactured by reputable RV appliance makers and have been tested by independent laboratories to meet all applicable standards and codes set for RV appliances.

REFRIGERATOR

The refrigerator in your coach can be operated from either of two power sources available to the motor home:

- 110-Volt AC electric
- LP gas

	CAUTION
To prevent permanent damage to the refrigerator cooling unit, turn the refrigerator off if the vehicle will be parked on an incline of over 3° side-to-side or 6° front-to-rear (such as steep driveways or parking lots, etc.) for more than one hour.	

Leveling

Before operating the refrigerator when the motor home is stationary, place a small level on the freezer plate and make certain the unit is level.

Normal vehicle leveling to provide comfort for the occupants is satisfactory for refrigerator operation.



Place bubble level in bottom of refrigerator

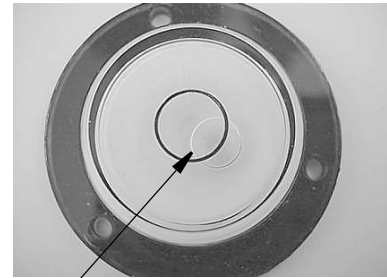

Bubble must be 1/2 inside circle

If over 1/2 of the bubble is inside the circle in any direction, the coach is level enough for continuous operation of the refrigerator while parked.

Further Information

For further information and operating cautions, see the refrigerator operating instructions included in your Owner InfoCase.

ICE MAKER

-If Equipped

Some refrigerators are equipped with an automatic ice maker system. The ice maker unit is installed in the freezer compartment of the refrigerator.

See the refrigerator manufacturer's operation, care and maintenance information in your InfoCase.

NOTE: A water shut-off valve for the ice maker is located near the water faucet filter inside the galley cabinet beneath the sink.

REFRIGERATOR SERVICE ACCESS COMPARTMENT

(Exterior)

The exterior refrigerator service compartment allows access to the rear of the refrigerator for inspection, maintenance and service.

To Open:

1. Use a screwdriver or coin to turn the latch knobs to the vertical position as shown.

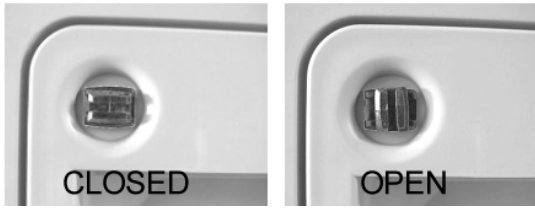

Refrigerator Access Door Latches

2. Remove the door from the opening.

To Close:

1. Replace the door into the opening.
2. Push the latch knobs in while turning to the horizontal position as shown.

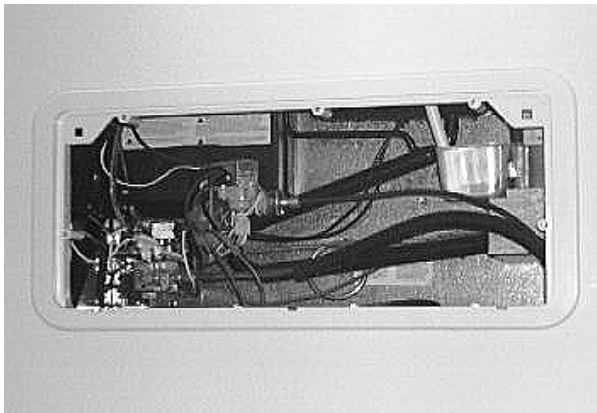

Refrigerator Access Compartment

RANGE AND OVEN

Optional



The range and oven in your motor home operate on LP gas and will provide nearly all of the functions that the range in your home does.

The range has a “Pilot Off” position on the oven control which allows the oven pilot to be turned off when traveling or refilling the LP tank.

Avoiding Asphyxiation

The following warning label has been located in the cooking area to remind you to provide an adequate supply of fresh air for combustion.

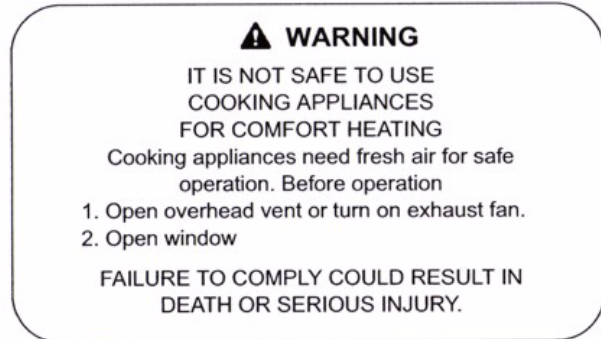

Unlike large homes, the oxygen supply inside a recreational vehicle is limited due to its size. To avoid danger of asphyxiation, provide proper ventilation when using the gas rangetop or gas oven. It is especially important not to use the gas oven and range top for comfort heating. Danger of asphyxiation is greater when these appliances are used for long periods of time.

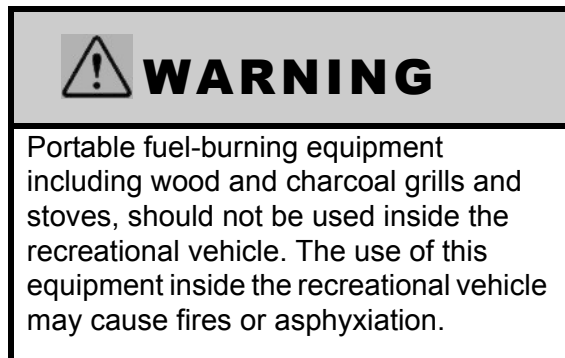

Further Information

For further information and operating cautions, see the operating instructions included in your Owner InfoCase.

MICROWAVE OVEN

For complete operating instructions, refer to the manufacturer’s information provided in your Owner InfoCase.

RANGE HOOD

The range hood vent is built into the underside of the microwave oven. The range hood fan carries cooking odors and gas fumes to the outside of the coach. A light on the underside of the hood provides illumination for food preparation. The hood fan and light switches are located on the microwave control panel.



See the manufacturer's information in your Owner InfoCase for instructions on replacement of light bulbs and grease filter elements.

ONEPLACE SYSTEMS MONITOR PANEL

The ONEPLACE Systems Monitor Panel provides a convenient, central location for checking the condition of all utility systems in your coach. It also includes the TRUEAIR climate control thermostat and the POWERLINE Energy Management System status panel.

At the touch of a button this panel can display the fresh water and holding tank levels, LP gas tank level, plus the engine battery and coach battery condition. You can start the auxiliary generator or turn on the water pump and water heater. Indicator lights tell you if the water pump is on or if the water heater pilot light is out.



One Place Monitor Panel

Generator Start/Stop Switch

See Electrical Systems section for generator start-up and shut-down instructions.



Generator Switch and Hourmeter

Generator Hourmeter

See Electrical Systems section for generator hourmeter information.

Water and Holding Tank Levels

Press and hold the appropriate switch to show approximate tank level on the monitor lights



The approximate fluid levels are measured by sets of electronic sensors (detector cells) on the sides of the tanks. There is generally more fluid in a tank than indicated on the monitor panel.

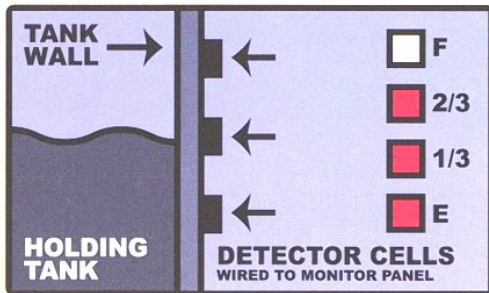

For example, if the fluid level is 1-2" below the FULL sensor, the monitor will show the level to be only 2/3 even though the tank is nearly full. If the fluid level is below the 1/3 sensor, the monitor will register an empty tank even though there may actually be some water left in the tank. However, when the indicator reads FULL, the tank is actually full.

Tank Capacities

See Section 1 - Tank Capacities.

LP Gas Level

Press and hold the "LP GAS" switch to show approximate LP tank level.

The LP level is registered by a sending unit on the tank. The gauge mounted on the side of the tank will give a more accurate indication of actual tank level if needed.

Water Pump Switch

When you want to use the self-contained water system, turn on the "Water Pump" switch on the monitor panel. The "Pump On" light will

illuminate when the pump switch is turned on. Water will be available as soon as a faucet is opened.

For your convenience, a switch is also located in the water center compartment.

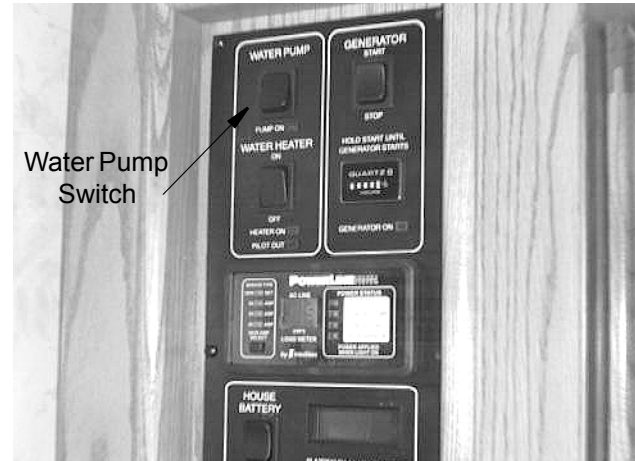

Battery Voltage Meter

Push the "House Battery" button to check the level of charge (voltage) in the 12-volt coach battery.

To get an accurate reading;

1. Both the chassis engine and the auxiliary generator engine must be shut off.
2. An interior light should be turned on to provide a small load which draws off the battery surface charge.



The LCD display will show the current battery voltage to the nearest tenth of a volt.

- A 12-volt battery typically registers anywhere from 12.5V to 13V when adequately charged.
- Voltage below 12V indicates a moderately discharged condition; 11.5V or less is extremely discharged.

- Voltage above 13V typically indicates that the battery is being charged by the inverter charger system.

SOLAR CHARGER PANEL

The 10-watt roof-mounted solar charger panel uses the sun to help keep your house batteries charged. A charge indicator light is provided on the One Place panel to show you when the solar panel is actively charging the house batteries.

The red light will glow when the solar panel is charging the coach batteries. The greater the rate of charge, the brighter the light. When the batteries reach full charge, the light will gradually dim, then darken.

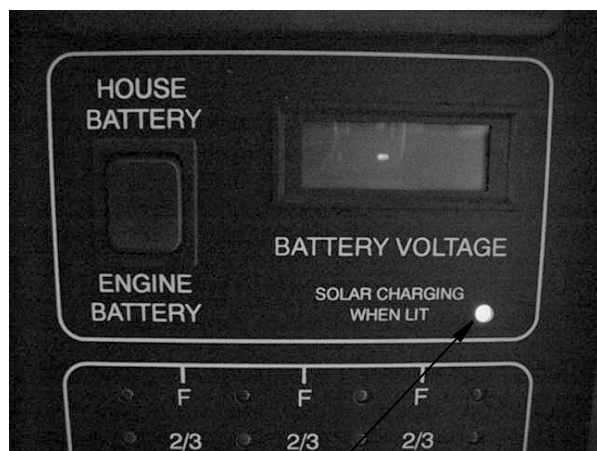

Solar Charging Indicator

NOTE: The solar battery charger is not intended to make the coach battery system “maintenance free.” The solar panel will not completely compensate for continuous low amperage draw from components such as the LP gas leak detector, the clock in the dash radio and the radio station memory circuitry, for example.

Although the solar panel system can help to extend battery life, the coach shoreline should be plugged in routinely to “top off” the batteries. We also recommend following regular battery inspection and maintenance, especially in cold weather.

See “Battery Storage and Maintenance” in this section.

**The solar panel circuit breaker is located in the automotive breaker panel behind the front ‘hood’ panel.*

POWERLINE ENERGY MANAGEMENT SYSTEM (EMS)

The Energy Management System (EMS) monitors the electrical usage of the appliances and equipment in the coach and distributes the electrical loads to avoid nuisance tripping of the shoreline circuit breaker. This system works together with the energy efficient central air conditioner to allow you to run both compressor units at the same time on a 30-amp shoreline connection.



PowerLine EMS Display on OnePlace Monitor Panel

Please read your PowerLine Energy Management System Owner Guide for important information on running both air conditioner compressor units at the same time. This guide will also explain how this system operates under several conditions, whether 20-amp, 30-amp or 50-amp connections.

**GAS/ELECTRIC WATER
HEATER**
(with Motor Aid water heating
system)

The gas/electric water heater has a dual power feature. It can operate from LP gas or 110-volt house current; or it can use both at the same time for quicker recovery at times when you are using a lot of hot water.

Read the Water Heater Operation Manual for complete Safety Warnings, Operating Instructions and Maintenance Information before operating the water heater.

Be sure the water heater is filled with water before starting either electric or LP operation. To fill the water heater, turn the Water Pump switch on and open a hot water faucet anywhere in the coach. When water begins to flow steadily from the faucet, the water heater is full.

For LP Gas Operation

Press the Water Heater switch on the Monitor Panel. The “Pilot Out” light will glow for about 10-15 seconds, then it will go out. The “Heater On” indicator will remain lit. If the “Pilot Out” light comes on during LP operation, it means that the burner has gone into “lockout” mode and must be restarted. If this happens, turn the Water Heater switch off for about 5 minutes, then turn it back on.

See the water heater user’s guide in your Owner InfoCase for further information.



For Electric Operation

Turn on the Water Heater electric element switch. The shoreline must be connected or generator running for electric operation.



Electric Water Heater Switch
(Typical)

**For Quick Recovery Operation
(Dual Heating)**

Turn On both Water Heater switches; the gas one on the monitor panel and the electric one. This will help reheat the water heater tank more quickly than a single source would alone. Use this mode when you are using a larger than normal volume of hot water.

Operating Instructions

Read the operating and safety information provided in the Water Heater Operation Manual in your Owner InfoCase.

**PRESSURE-TEMPERATURE
RELIEF VALVE**

On occasion, water may be seen seeping from the water heater pressure temperature relief valve. This is no cause for repair or replacement of the valve.



Water Heater Exterior Service Access

Normally there is an air gap at the top of the water heater tank which acts as a pressure buffer. In time, however, heated water may expand and fill this air gap, causing a slight increase in water pressure. This may cause the P-T valve to “weep” until the air gap is manually replaced.

 CAUTION
<p>Operate this valve only when the water heater and engine cooling system are cold!</p>

To Replace the Air Gap:

1. Turn off the water heater switch and incoming water supply (city water and/or demand pump).
2. Open a faucet in the motor home to relieve water pressure.
3. Pull the handle of the P-T valve straight out and allow water to flow until it stops.



Lift handle straight out to open P-T valve

4. Let the handle of the P-T valve snap shut.
5. Close the faucet and turn on the water supply before switching the water heater on.

Manually operate the pressure temperature relief valve at least once a year.

MOTOR AID WATER HEATER

The motor aid uses heat from the chassis engine cooling system to heat water in the water heater while driving. Hoses are routed from the engine to a heat exchanger surrounding the water heater tank.

Under normal conditions, the entire contents of the water heater can be heated in about two hours or 100 miles of driving. This means you can have hot water at the faucets immediately upon arriving at a site.

The motor aid also increases the capacity of the engine cooling system, allowing the engine to run cooler under many conditions.

 CAUTION
<p>Any leak in the heat exchanger or its supply or return lines could cause loss of coolant and subsequent engine failure. We recommend that you periodically inspect these connecting lines and the heater to insure that no leaks have developed.</p>

WATER HEATER BY-PASS VALVE

Your coach is equipped with a water heater by-pass valve for easier winterization of water lines using RV antifreeze. The valve is located in the water service center on the outside of the coach on most models*



Water Heater By-Pass Valve



CAUTION

Leave by-pass valve handle in Normal Operation position if draining water and blowing out water lines. Place in Bypass position **ONLY** when using antifreeze solution in water lines.

LP GAS FURNACE

To Start Up:

1. Open the LP gas tank valve by turning fully counterclockwise
2. Move FAN MODE switch to Auto and place FAN SPEED switch in desired position - Lo or Hi.
3. Move THERMOSTAT switch from Off to Heat and press the Temp Selector button (Up/Down arrows) until the desired temperature is shown in the display.
4. Furnace fan will start to blow immediately after setting thermostat.

5. After about 30 seconds, the furnace burner will light.
6. The furnace will now cycle off and on automatically as the thermostat demands just like a household furnace.

NOTE: If heat does not come out of the heat ducts after a minute or so the burner is not lit. Turn thermostat off for 3-5 minutes, check to be sure tank valve is open and tank is not out of fuel, then try steps 2-4 again. If it still will not light after three attempts, go to Shut Down steps and contact your dealer or a local RV service center.

NOTE: Metal coatings used during manufacture of the furnace burner parts may smoke when the furnace is used for the first time, which may also set off your smoke alarm. If this happens, provide adequate ventilation of the smoke to avoid a nuisance smoke alarm at this time. We do not recommend removing the smoke alarm battery. If it were inadvertently left disconnected, the smoke alarm would be inoperative.

To Shut Down:

Slide thermostat/system switch OFF.

Further Information

Please see the furnace operating instructions provided in your Owner InfoCase for further information, including operating precautions, and periodic maintenance.

ELECTRONIC THERMOSTAT (Central Heat/Air Conditioning System)

The thermostat, on the One Place panel, controls heating, air conditioning, cooling fan and heat pump operation.

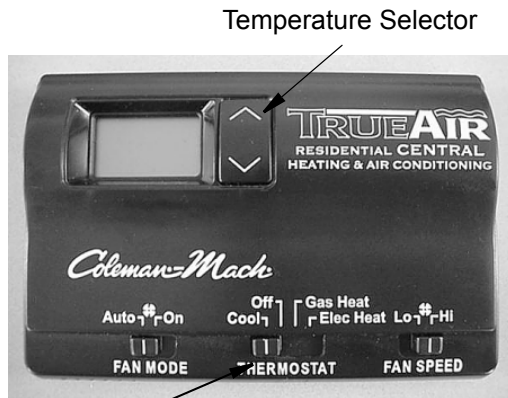

Heat Source Switch
ELECTRIC = Heat Pump
GAS = Furnace

True Air Thermostat

NOTE: The thermostat does not automatically switch between heating and cooling. You must place the thermostat switch in the desired position.

Heating:

- Slide the thermostat switch to “Gas Heat” position.

NOTE: Follow proper furnace lighting procedures described previously in this section.

- Adjust the temperature setpoint to personal preference if needed. See “Changing Temperature Setpoints.”

Digital Thermostat Display

The digital display normally shows current room temperature, with the word “ROOM” in small letters at the left side of the display. When you press the temperature selector button up or down, the display will show the word “SET” and the new temperature setpoint until you release the button.

Changing Temperature Setpoints

To set the temperature to a new temperature, simply press the Temperature Selector button up or down until the temperature you want appears in the display. The word “SET” will also appear at the left side of the display while you are changing the temperature setpoint. A few

seconds after you release the temperature selector button, the display will return to showing the current room temperature.

Cooling (A/C):

- Slide the thermostat switch to Cool position.
- Slide the Fan Mode and Fan Speed Switches to the desired positions.

On/Low: A/C compressor cycles on and off with the thermostat while fan runs continuously at low speed.

On/High: A/C compressor cycles on and off with the thermostat while fan runs continuously at high speed.

Auto/Low: Fan runs at low speed and cycles on and off with the A/C compressor as controlled by the thermostat.

Auto/High: Fan runs at high speed and cycles on and off with the A/C compressor as controlled by the thermostat.

- Adjust the temperature setpoint to personal preference if needed. See “Changing Temperature Setpoints”.

To Run Fan Only (No Heat or Air)

- Set Thermostat switch to OFF.
- Slide Fan Mode switch to On.
- Place Fan Speed switch to Lo or Hi as desired
- The fan will run continuously at the selected speed and is not controlled by thermostat setting. The display will show current room temperature.

THERMOSTAT OPERATION

The following chart shows the system functions with the “Heat/Cool” thermostat. Disregard references to heat functions when using the “Cool Only” thermostat in the rear bedroom.

■ Switch position —■— Switch position does not matter or is inactive for this feature

FAN MODE SWITCH		THERMOSTAT SWITCH				FAN SPEED SWITCH		WHAT HAPPENS
Auto	On	Cool	Off	Gas*	Elec*	Lo	Hi	
			■					If the Thermostat Switch is Off, the whole heating and cooling system is off— nothing is happening.
Gas Furnace Heating:								
—■—	—■—			■		—■—	—■—	Furnace Blower runs along with the LP Gas Furnace which turns on and off as needed according to thermostat setting.
Heat Pump Heating:*								
■					■	—■—	—■—	A/C Fan runs at Low Speed along with the Heat Pump which turns on and off as needed according to thermostat setting.
	■				■	—■—	—■—	A/C Fan runs continuously at Low Speed while the Heat Pump turns on and off as needed according to thermostat setting.
A/C Cooling:								
■		■				■		A/C Fan runs at Low Speed along with the Air Conditioner which turns on and off as needed according to thermostat setting.
■		■					■	A/C Fan runs at High Speed along with the Air Conditioner which turns on and off as needed according to thermostat setting.
	■	■				■		A/C Fan runs continuously at Low Speed while the Air Conditioner turns on and off according to thermostat setting.
	■	■					■	A/C Fan runs continuously at High Speed while the Air Conditioner turns on and off according to thermostat setting.

NOTE: The thermostat is equipped with a replaceable 2 Amp fuse located on the back of the thermostat body.

HEAT PUMP

Your coach is equipped with an air source heat pump built into the central air conditioning system. Because the heat pump operates on electricity, it provides economical heat inside your coach and helps reduce the use of LP gas for heating in cooler weather.

A heat pump can be thought of as an air conditioner running in reverse. An air conditioner absorbs heat from the air inside of the coach and moves it to the outside. The heat pump does exactly the opposite. Even cold air contains some heat, so a heat pump will extract heat from

the outside air on a cold day and carry it to the inside of the coach to maintain a comfortable temperature.

The efficiency of a heat pump decreases as the outdoor air temperature drops, so supplementary heat is often needed when the outside temperature nears freezing. This system is set to automatically start the LP gas furnace to assist the heat pump if room temperature cools to 5 degrees or more below the thermostat setpoint. You may wish to manually switch to furnace heat to maintain a higher temperature when outside temperatures begin to reduce the efficiency of the heat pump. The heat pump will not operate when the outside temperature falls below 36 degrees.

To Operate the Heat Pump:

See the air conditioning/heat pump manufacturer’s information in you Owner InfoCase for complete operating instructions.

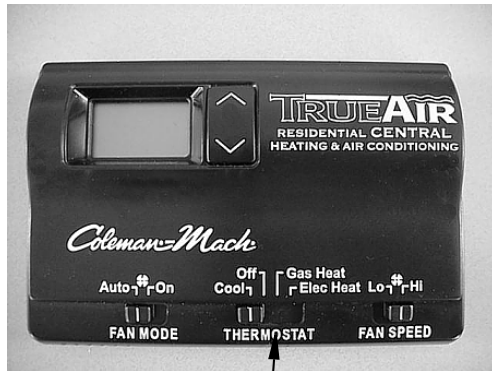

Thermostat Switch
Gas Heat = Furnace Only
Elec Heat = Heat Pump

CENTRAL AIR CONDITIONER

NOTE: See “Electronic Thermostat” for instructions on turning the air conditioner on and changing the thermostat settings.

The central air conditioner is located behind the louvered body panel on the right (passenger) side of the coach. The panel can be opened for maintenance and periodic service. (See “Condenser Coils”) The cooled air is forced through ducts in the ceiling of the coach. Inside air returns to the air conditioner through a filter system beneath the rear bed. (See “Air Conditioner Filter”).

AIR CONDITIONER FILTER

The disposable furnace type filter must be inspected and replaced periodically so the air conditioner will operate efficiently.

- Be sure ceiling vents are open to distribute heat pump output air. Also make sure furniture, clothing items, packages or other obstructions do not block the air return air grilles beneath the rear bed.
- The filter should be checked monthly for dirt build-up and replaced as needed.

**The air filter is a disposable woven fiberglass type, which cannot be cleaned and should be replaced when coated with dust.*

Filter Location

Beneath Night Stand Cabinet

(Lift carpeted panel as shown... a finger hole is provided near the middle of the panel for lift-out removal).



A/C Filter Size: 14” x 20” x 1”

NOTE: Do not block the filter in any way, such as by setting packages or newspapers, etc. in front of the night stand grate. There must be free air flow for the air conditioner to operate efficiently.

Condenser Coils

The condenser is located behind the louvered body panel on the right side of the coach. The condenser is the large, black, rectangular area that looks like a car radiator. The panel is hinged at the top edge to allow opening for periodic cleaning or service. Remove the screws under the lower edge of the panel and swing it upward for access to the condenser.

Periodically sweep debris carefully from the fins of the condenser. Rinse dust off with clean water. The condenser coils must be clean and free of dust, debris and insect particles, etc., for the air conditioner to cool efficiently.

Further Information

See the air conditioner manufacturer’s operating instructions supplied in your Owner InfoCase. They contain detailed operating instructions, special precautions and basic troubleshooting.

ELECTRIC ENTRANCE STEP

The power switch for the electric entrance step is located to the left of the main entry door as you enter the coach.



Step Switch



WARNING

Do not use step unless fully extended.
Do Not Stand on step when vehicle ignition switch is turned to either the "On" or "Start" position.
The step will automatically retract, which may cause personal injury.

Automatic Mode - Entry Step Switch ON

(Step Operates with Door)

With the Entry Step switch in the ON position the step is in Automatic Mode. This means it will extend and retract automatically whenever the screen door is opened or closed.

Stationary Extended Mode - Entry Step Switch OFF

(Step Remains Extended)

With the Entry Step power switch in the OFF position the step will extend when the screen door is opened and will stay extended whether the door is opened or closed.

This position is normally used to keep the step extended when parked at a campsite or whenever people will be entering and exiting the vehicle frequently.

Automatic Retraction Feature

The step is equipped with an automatic retraction feature that stores the step automatically when the Ignition Switch key is turned to the On or Start positions and the entrance door is closed.

The step will retract regardless if the Entry Step power switch is ON or OFF.

This feature is intended to prevent injury or damage by an extended step while the vehicle is moving.

Further Information

For additional information on the step, see the manufacturer's operators manual included in your Owner InfoCase.

STEPWELL COVER

The stepwell cover can be extended to cover the stepwell area and increase usable floor space in the front of the coach while the entrance door is not in use.



Step Cover shown in extended position

Press and hold the Step Cover switch on the passenger sidewall armrest. The step will extend or retract fully.



Step Cover Switch

⚠ CAUTION

Stay clear of entrance step area when stepwell is being extended or retracted. When entering or exiting, loose clothing may catch on components of the mechanism. Personal injury and/or property damage may result.

WINDOWS

Crank-Out Windows

Turn the crank-out knob clockwise to open window; counterclockwise to close. Do not use excessive force on the knob to open or lock into closed position. This could cause permanent damage to the crank mechanism.

When closing the window, crank the window in snugly, then back off 1/4 turn to help avoid glass warping which can result in wind noise.



If the window will not open after three or more full turns of the knob, the glass may be stuck to the sealing gasket. Go to the outside of the coach

and gently free the glass with your fingers. A periodic light dusting of talcum powder on the gasket should prevent this from recurring.

Horizontal Slider Windows

Swing the latch handle straight out from the window. Grasp the sliding window edge frame and slide the window to the side. Be sure the latch is open before trying to slide the window closed.



Vertical Slider Windows

Vertical windows have spring-loaded catches on both sides of the window that pop out to hold the window in its fully raised position. Press the catches outward toward the frames while lowering the window.



Vertical Window Catches

POWER ROOF VENT

Galley or Bath Area

The power roof ventilator has a 3-speed turbine fan.

The fan shroud on the ceiling has a fan power switch that lets you turn the fan off if you want the vent dome raised with no fan running.

The fan speed switch lets you adjust the amount of air circulation you need at any time.

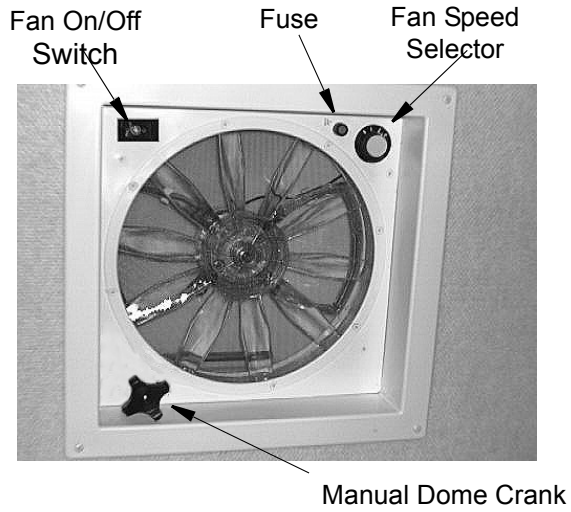

Power Roof Vent
Galley or Bath

Further Information

See the power vent manufacturer's operating instructions supplied in your Owner InfoCase.

Journey ^{SE}

SECTION 5 LP GAS

LP GAS SUPPLY

The LP gas system supplies fuel for the range, water heater, furnace and refrigerator (while in gas mode). When used and handled properly, this system is safe and economical and provides modern living conveniences wherever you travel.

How LP Gas Works

LP (Liquefied Petroleum) gas is a true gas compressed into liquid form for easy transportation and storage. LP gas is available in two types - propane and butane. It is also called tank gas, bottle gas, or simply LP.

LP is used by appliances in vapor form only, but is stored in the tank as a liquid under very high pressure. As the liquid gas is released, it reverts back to a vapor and expands to many times its compressed volume.

LP Tank System

The storage reservoir for the LP gas system is a horizontally mounted tank which is permanently attached to the vehicle frame. The tank is accessible only from the outside of the vehicle. The tank supply valve is located near the top center of the tank, next to the regulator.

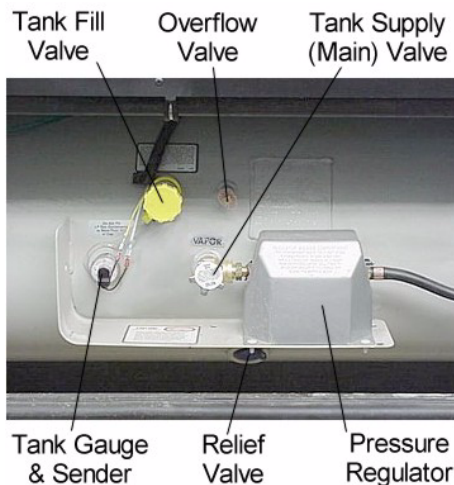

WARNING

Do not alter or remove LP tank gauge at any time.

Refilling LP Tank

Since the LP tank is permanently mounted to the frame, the motor home must be taken to an LP dealership for filling. Do not attempt to remove the LP tank from the vehicle. The tank is equipped with a fill adapter with both internal and external threads which allows easy filling with any LP filling equipment. The tank is full when liquid LP gas appears at the overflow valve.

NOTE: The LP tank is equipped with an automatic 80% stop-fill device.

 **DANGER**

DO NOT FILL CONTAINER TO MORE THAN 80 PERCENT OF CAPACITY. FAILURE TO COMPLY COULD RESULT IN A FIRE OR PERSONAL INJURY.

Make sure the motor home is level when filling. It is possible to accidentally overfill the tank if the vehicle is unlevel, with the fill valve on the uphill side. Overfilling the LP gas tank can result in uncontrolled gas flow, which can cause fire or explosion. A properly filled container will contain approximately 80 percent of its volume as liquid LP gas.

All pilot lights must be extinguished and supply valve closed before refilling LP gas tanks or vehicle fuel tanks.

Do not smoke or expose an open flame while near an LP refueling area. LP gas is heavier-than-air and extremely flammable.

Never fill the LP tank with engine or generator running.

Before opening the supply valve, check to be sure all controls for gas appliances are in the "Off" or "Pilot Off" position. If this step is not performed, LP gas could accumulate inside the motor home creating a fire or explosion hazard.

Never use an open flame to test for LP gas leaks.

Replace all protective covers and caps on LP system before filling.

Selecting LP Fuel Types

We recommend using straight propane in your LP tank. Propane gas is commonly available at all LP gas outlets in the U.S. (According to the National LP Gas Association, LP gas outlets in the United States do not offer any other type of liquefied petroleum gas than propane to the general public.) Check local phone directory yellow pages for locations of local LP gas refilling stations or bulk dealerships.

NOTE: If you travel outside the U.S. with your motor home, you may find butane or propane/butane mixtures available in addition to propane. Because gas-burning RV appliances are designed to run on propane only, we recommend that you request straight propane only. Butane burns about 30 percent hotter than propane and can overheat some appliances, particularly refrigerators, and cause permanent damage. Other appliances designed to operate on propane can become sooted and lose efficiency by using butane fuel.

Air In The LP Gas Tank

If your LP gas appliances do not stay lit or require frequent adjustment, even though you know the LP tank contains sufficient fuel, the problem may be air in the LP gas tank. Air in the tank mixes with the LP gas vapors causing them to burn poorly. This condition could linger for weeks if the air is not purged from the tank. Most LP gas dealers have equipment for purging air from LP gas tanks and will purge before refilling the tank.

SAFE USE OF THE LP GAS SYSTEM

The LP system is designed and built with strict adherence to federal, state and recreational vehicle industry requirements for mobile LP gas equipment.

For your safety, there are many safety devices and backup systems installed, such as tank fill overflow valves, an interior LP gas detector/ alarm, and an interior carbon monoxide (CO) detector/alarm.

LP gas also contains an odor additive that you can smell if LP is present in the air.

Listed below are a few precautions to observe that will help you to use the LP gas system safely.

- Exercise caution at all times. Be familiar with the distinctive odor of LP gas. If a leak is suspected, turn off the supply valve

immediately. Have the LP gas system checked by your dealer or other qualified LP gas service center.

- Do not tamper with the LP gas piping system, pressure regulator or gas appliances. Service and maintenance of LP gas system components should be performed only by your dealer or a qualified LP gas service center.
- Never attempt to connect natural gas to the LP gas system.
- Have the entire LP gas system inspected for possible leaks and missing or damaged parts at each tank filling. Also inspect before and after each trip, and any time trouble is suspected.
- Turn the LP supply valve off when not using the LP gas system.
- Never use a wrench to tighten the tank supply valve. It is designed to close leak-tight by hand. If a wrench is required to completely close the valve, it is defective and must be replaced.
- Be sure appliance and outside vents are open and free from obstruction when using the LP gas system.
- Never attach a lock or any device requiring a key to the LP tank compartment door. According to standards set for recreation vehicles, the LP supply valve must be readily accessible in an emergency.
- Exercise caution when drilling holes or attaching objects to the walls. Gas lines and electrical wiring could be seriously damaged and present an extreme safety hazard.

LP GAS WARNINGS AND PRECAUTIONS

It is illegal for vehicles equipped with LP tanks to travel on certain roadways or through certain tunnels in the U.S. To avoid inconvenience, check state regulations concerning flammable gas transportation.

LP Gas Leaks

The following label is located in the vehicle near the range area. If you smell gas within the vehicle, quickly and carefully perform the procedures listed.

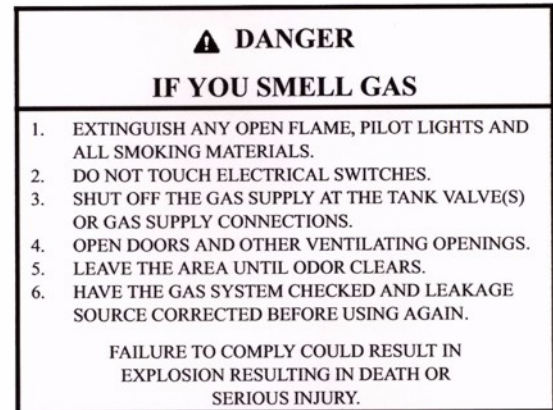

- All pilot lights must be extinguished and appliances turned off while refilling the fuel tank or LP tank.
- Never smoke while refilling vehicle fuel tank or LP gas tank.
- Avoid inhaling exhaust gases produced by burned gasoline, diesel fuel or LP gas in items such as the range, chassis engine, generator engine, refrigerator, furnace and water heater. They contain carbon monoxide, which is an odorless, colorless and poisonous gas.
- Do not bring or store LP gas containers, gasoline or other flammable liquids inside the vehicle because a fire or explosion may result. LP gas containers are equipped with safety valves which relieve excessive pressure by discharging gas to the atmosphere.
- Never use an open flame to test for LP gas leaks. Replace all protective covers and caps on LP system after filling. Make sure valve is closed and door latched securely.
- Portable fuel-burning equipment, including wood and charcoal grills and stoves, shall not be used inside the recreational vehicle. The use of this equipment inside the recreational vehicle may cause fires or asphyxiation.

Regulators are equipped with a protective cover. Make sure that the regulator vent faces downward and that the cover is kept in place to minimize vent blockage which could result in excessive gas pressure causing fire or explosion.

PRESSURE REGULATOR

The pressure regulator is protected from the elements by a plastic cover which should be left in place at all times. Only your dealer or a qualified LP gas service should remove the regulator cover for adjustments.



WARNING

Visually inspect the pressure regulator vent periodically for blockage by accumulated debris or insect nests, etc. Vent obstruction could result in excessive pressure which could cause a fire or explosion.

If any obstruction is apparent, have the regulator serviced by your dealer or a qualified LP gas service center.

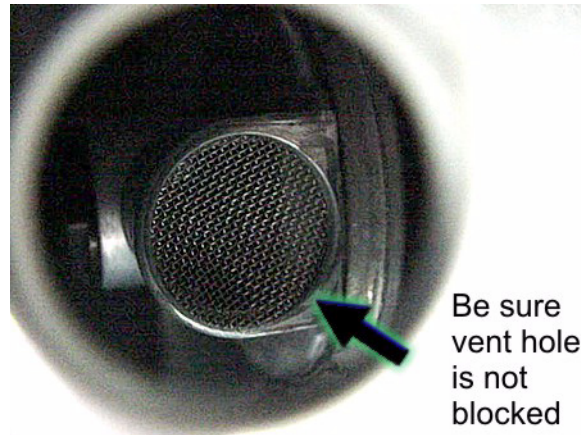
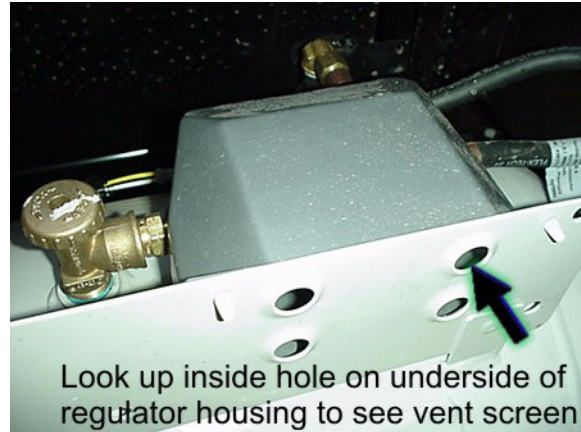

Regulator freeze-ups are caused by the presence of moisture in fuel. This moisture will pass through the cylinder valve and into the regulator where it can freeze. Fuel producers, tank and bottle manufacturers and LP gas dealers take every precaution to reduce moisture, but sometimes only a fraction of an ounce entering the tank can cause problems. To help avoid the possibility of freeze-up, always keep tank control valve closed when not in use, even when tank is empty, to prevent moisture from collecting on the inside.

If regulator freeze-up should occur, you may attempt to thaw the regulator using a light bulb. **DO NOT USE AN OPEN FLAME OR HEAT LAMP.**

If moisture begins to cause problems, have your LP gas dealer inject a small amount of dry methyl alcohol in your tank (approximately one ounce to 20 pounds or one pint to 100 gallons) to help guard against regulator freeze-ups.

In very cold weather when a large volume of gas is being used for heating, it is possible to experience a loss of gas pressure. At first, this problem may appear to be caused by a regulator freeze-up, but is actually caused by failure of the liquid gas to vaporize as fast as it is needed. As the temperature becomes colder, it is increasingly harder for the liquid LP gas to vaporize. At the same time, the demand for LP to produce heat increases to the point where the system cannot maintain production.

The only solution to this problem is to reduce the consumption of gas where possible. Adjusting the temperature on the gas/electric refrigerator may be a first step. Using less hot water will help as well.

SECTION 6 ELECTRICAL

Your coach is equipped with an electrical system consisting of two separate voltages; a 12-volt DC system and a 110-volt AC system. The 12-volt system consists of two internal power sources, while the 110-volt system is operated from an outside power source or the 110-volt generator. All systems operate through a single power converter control center to provide electrical power to the motor home.

ELECTRICAL CAUTIONS

- Careless handling of electrical components can be fatal. Never touch or use electrical components or appliances while feet are bare, while hands are wet, or while standing in water or on wet ground.
- Improper grounding of the vehicle can cause personal injury. Do not plug the utility power cord into an outlet which is not grounded and do not adapt the plug to connect to a receptacle for which it is not designed.
- Do not attach an extension cord to the utility power cord.
- Be sure that all electrical appliances to be used contain 3-prong plugs for proper grounding.
- Avoid overloading electrical circuits. Replace fuses or circuit breakers with those of the same size and amperage rating only. Never use a higher rated fuse or breaker.
- Use caution when handling or working near electrical storage batteries. Always remove jewelry and wear protective clothing and eye covering. Avoid creating sparks.

110-VOLT AC SYSTEM

The 110-volt system operates from the power cord (shoreline) connected to an outside 110-volt utility service such as those at campgrounds, or from the 110-volt generator (or the optional 110-volt inverter system). When the power cord is connected to an outside power source, or when the generator is in operation, the power converter

automatically changes a portion of the 110-volt current to 12-volt DC current. All equipment in the motor home that is normally powered by the auxiliary battery is then powered through the converter.

In addition, the following equipment is entirely dependent on 110-volt current: central air conditioner, refrigerator (when placed in AC mode), microwave oven, ice maker, vacuum cleaner and other 110-volt electrical equipment used at convenience outlets.

EXTERNAL POWER CORD (Shoreline)

The external power cord (commonly referred to as a “shoreline”) is located in a the utility compartment on the left (driver’s) side of the coach.



Utility Compartment



WARNING

Do not connect the external power cord to any receptacle **until** you have contacted the owner and/or attendant of the premises to verify proper polarity and grounding.

It is the responsibility of the owner of the electrical receptacle to ensure that the receptacle is properly wired and grounded.

Reverse polarity and improper grounding of the vehicle can cause personal injury or death.

The power cord is designed to ground the electrical system through the receptacle. It is also designed to carry the amperage output of most campground outlets. If the electrical receptacle to be used is designed to mate with the prongs of the power cord plug, the electrical connection can be expected to carry rated load.

Connecting The Power Cord

To connect to an external source, remove the cord from the utility compartment and plug it into a suitable 50-amp power receptacle to provide external power to the coach and converter/charger system.

NOTE: Some parks do not have 50-amp service available, so you will need to connect to a standard 30-amp service pole using an adapter.

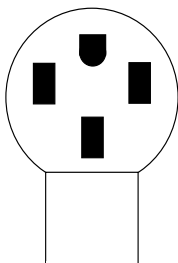

50 Amp.
Power Receptacle

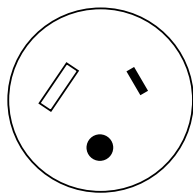

30 Amp Receptacle

A flip down hatch in the compartment floor lets you route the power cord through a passage

in the bottom of the compartment so you can shut the compartment door while the power cord is connected.



1. Flip the hatch downward.



2. Swivel the cover section aside to reveal cord notch.



3. Route the cord through the notch and flip the hatch back up into place and close the compartment door.

WARNING

Do not plug the power cord into an outlet which is not grounded, or adapt the plug to connect to a receptacle for which it is not designed.

Be sure that all four prongs of the supply cord are properly plugged into the receptacle.

Do not connect the power cord to an extension cord.

Park Fuses or Breakers

Most campgrounds are equipped with a fuse or circuit breaker at the receptacle. This protects the park’s wiring, as well as the power cord on your vehicle, from electrical damage. If electrical power fails, contact the park attendants and have them check the fuse or breaker for your supply receptacle.

After disconnecting the power cord, neatly stow it in the utility compartment.

**POWER CENTER
(Converter)**

The power converter changes 110-volt AC current from the auxiliary generator or the shoreline into 12-volt DC current for use by 12-volt equipment in the motor home.

Certain circuits, however, remain unchanged for use by items which require 110-volt current, such as the air conditioner(s), the refrigerator in AC mode, the microwave oven, etc.

Current drawn from the coach batteries passes through the power center unchanged, although it is routed through a series of protective circuit breakers.

Charging Section

The converter charges coach batteries while 110-volt external power is connected.

If the coach batteries have been extremely discharged, they will accept charge at a relatively high amperage rate. If they are only slightly discharged, they will charge at a lower amperage rate. The rate of charge will decrease as the batteries reach “full charge”, then will continue “trickle” charging at a very low amperage rate.

If your battery does not charge as described above, it is possible the battery is defective.

If the batteries are extremely discharged, the charger unit will not activate to charge batteries

NOTE: We do not recommend leaving the shoreline plugged in continuously during storage periods because the batteries can lose electrolytic fluids and become damaged from continuous charging without periodic use. We recommend following regular battery inspection and maintenance, especially in cold weather. See “Battery Storage & Maintenance” at the end of this section.

Thermal Overload

A thermal overload will “break” the 110-volt AC power to the converter section of the Power Center if the power converter becomes overheated. This can result from operating above its maximum limit for an extended period of time or by obstruction of ventilation to unit.

NOTE: The power converter section will automatically route 12-volt lights and motors to battery power in this event.

The thermal overload will reset itself after a period of time, and the lights and motors will again resume operation from the power converter section. If the breaker trips again shortly after reset, take immediate steps to correct the cause of overheating. A portion of the coach 12-volt load (lights or motors or both) should be turned off to reduce total load. Also, inspect the power converter section to make sure ventilation is not obstructed.

INVERTER/CHARGER UNIT - 2000W

-Optional

The inverter/charger is located on the wall of the shoreline compartment. The inverter/charger has a power/reset switch and a circuit breaker to protect the inverter and the AC input source from overloads. See the manufacturer's operating information for complete explanation and instructions on this system.

NOTE: Batteries will deplete quickly with use of the inverter. The inverter is intended for limited, short term power usage while the vehicle is in motion or while not connected to shoreline or generator power. It is not intended for steady use while 'dry camping', without generator or shoreline power.

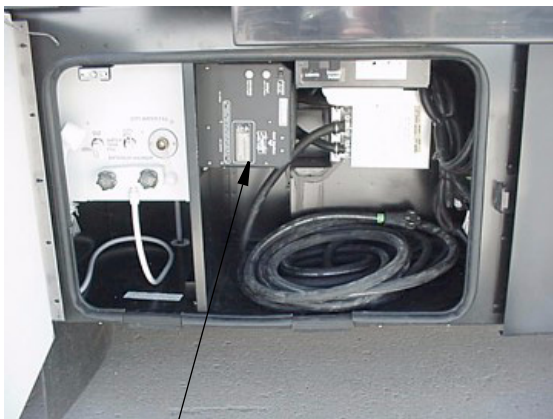

Inverter Charger Unit Location
in utility compartment

Inverter Control Panel:

- The inverter/charger has a remote monitor/control panel that can be programmed for several charging configurations.

See the inverter/charger remote panel instructions in your Owner InfoCase for complete information and specific configuration directions.

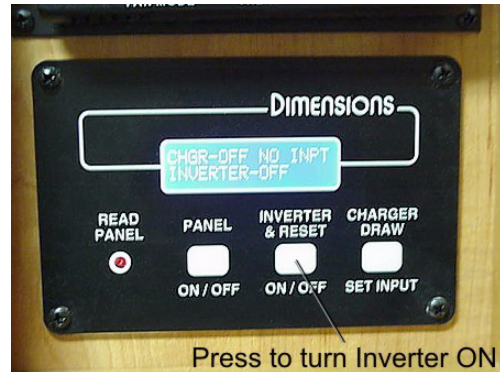

Inverter Charger Control Panel

When the inverter is not being used, it should be shut off at the control panel. The inverter could drain the house batteries if the shoreline is not connected to external power and the Aux. Battery switch is on.

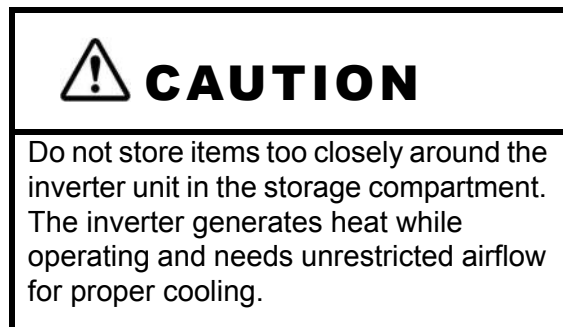

110-VOLT CIRCUIT BREAKERS

The breaker panel protects all 110-volt components in the motor home from either an overload on the circuit or a short in the wiring or component itself. When an overload or short develops, the breaker will open preventing any further flow of electricity and, therefore, damage to the system.

Shut off the equipment (example: air conditioner) and allow a brief cooling period. Then reset the breaker by moving the switch to "Off" and back to "On". If the breaker continually trips and no equipment is running, have the system checked for a short in the wiring or the appliances.

The 110-volt circuit breaker panel is located behind the cabinet door under the bed.



110-Volt House Circuit Breakers
(at foot of bed)

⚠ CAUTION

Do not store items too closely around the inverter unit in the storage compartment. The inverter generates heat while operating and needs unrestricted airflow for proper cooling.

If the GFCI keeps tripping, have the electrical system checked and repaired if necessary before using again.

The GFCI outlets are located in the bath and galley areas of the vehicle.

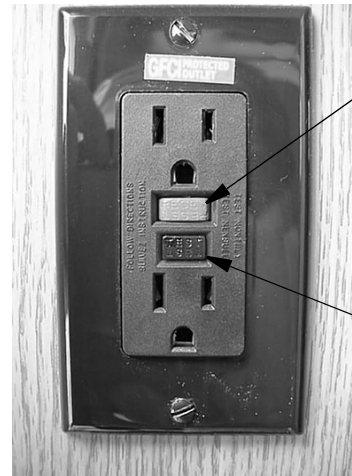

Push to Reset circuit after monthly testing or ground fault tripping.

Push to Test at least monthly. Should break circuit. Press Reset button to reconnect.

GFCI Outlet
(Ground Fault Protector)

⚠ WARNING

The GFCI will not completely eliminate electrical shock. Small children and persons with heart conditions or other disabilities which make them especially sensitive to electrical shock may still be injured by a 110-volt receptacles even though protected by a Ground Fault Circuit Interrupter.

**110-VOLT RECEPTACLES
(OUTLETS)**

A number of standard AC electrical outlets are provided throughout the coach for connecting small appliances such as televisions, radios, toasters, etc. An outdoor outlet is also located on the outside of the coach near the entrance door.

**GROUND FAULT CIRCUIT
INTERRUPTER**

Exterior, bath and galley outlets are connected to a GFCI (Ground Fault Circuit Interrupter), which is an extremely sensitive circuit breaker that will help to protect against severe electrical shock if a ground fault develops. If such a condition occurs, the GFCI will break the circuit by turning off the power to the protected outlets. If this happens, unplug all the appliances on that circuit and press the reset button on the GFCI equipped outlet.

AUXILIARY 110-VOLT GENERATOR

WARNING

Careless handling of the generator and electrical components can be fatal. **Never** touch electrical leads or appliances when your hands are wet, or when standing in water or on wet ground. **Do not** attempt to repair the generator yourself. Service should be performed by an authorized service center.

Automatic Power Transfer Switch

Whenever the generator is needed, an automatic power transfer system automatically switches the household electrical system to the generator 10 seconds after the generator is started. The ten-second delay allows the generator to start easily without the burden of electrical loads.

Generator Operation

Consult the generator manufacturer's information provided in your Owner InfoCase for instructions on operation, troubleshooting and maintenance.

NOTE: The generator draws its fuel from the main chassis fuel tank. After extensive generator use, you may notice decreased levels in the fuel tank.

Generator Hourmeter

This meter is located on the monitor panel. It registers the total number of hours that the generator has been operated.



Generator Hourmeter

Refer to the hourmeter to determine when periodic maintenance is due and to record services which have been performed.

Operation Warnings and Cautions

WARNING

The exhaust of all internal combustion engines contains carbon monoxide (CO). This poisonous gas is colorless, odorless, tasteless, and lighter than air. The exhaust systems of both your motor home engine and your generator engine have been installed with your safety in mind. However, certain precautions must be taken when using them to protect yourself from conditions beyond the control of the manufacturer.

1. **Do not** simultaneously operate the generator engine and a ventilator which could draw exhaust gases into the vehicle.
2. **Do not** open windows or ventilators on the end or side of the vehicle where exhaust pipe of the generator is located.
3. **Park the vehicle** so that the wind will carry the exhaust away from the vehicle. Also, note the position of other vehicles to be sure their exhaust will not enter your vehicle.
4. **Do not** operate the generator engine while parked if vegetation, snow, buildings, vehicles, or any other object can deflect the exhaust under or into the vehicle.

Check auxiliary generator oil level frequently during periods of use.

Refer to the generator manufacturer's maintenance information in your Owner InfoCase for specific recommendations.

WARNING

Never check generator oil level while generator engine is running.

12-VOLT DC SYSTEM

The DC voltage system consists of the automotive batteries and the 12-volt coach auxiliary batteries.

BATTERY INFORMATION

Chassis (Starting) Batteries

The chassis batteries operate the engine starter and all automotive accessories and controls found on the instrument panel. The leveling jacks, slideout room system and the electric step are also connected to the chassis battery.

A battery monitor device called Trik-L-Start will help maintain the chassis battery charge anytime the coach is plugged into 110-volt shore power and the battery disconnect switch is in the "On" position.

The device monitors battery voltage in the house batteries and compares it to the chassis battery. If the device senses the chassis battery voltage is approximately ½ volt lower than the house battery, it allows up to 5 amps of current to flow to the chassis battery.

The circuitry within the device prevents back feeding of electricity from the chassis to coach battery so if 110-volt power is interrupted, the chassis battery will not be discharged.

House Batteries

The house batteries supply current to 12-volt equipment located in the living area of the coach. This includes interior lights, range exhaust fan, furnace fan, water pump, water level and holding

tank gauges, 110-volt generator starter, refrigerator and bath roof vent fan. The house battery may also be used to start the engine if the automotive battery is discharged. Refer to "Aux. Start Switch."

The house batteries are automatically charged by the engine alternator while the engine is running.

AUXILIARY BATTERY (AUX BATT) SWITCH

The AUX BATT switch disconnects the auxiliary (coach) batteries from the 12-volt system of your coach to avoid long-term battery drain by electrical items that are hooked directly to the coach batteries, such as clock displays and radio memories, etc.

Leave this switch ON except for periods when the vehicle is not in use.

Some electronic displays and memory functions may need to be reset after power has been reconnected.

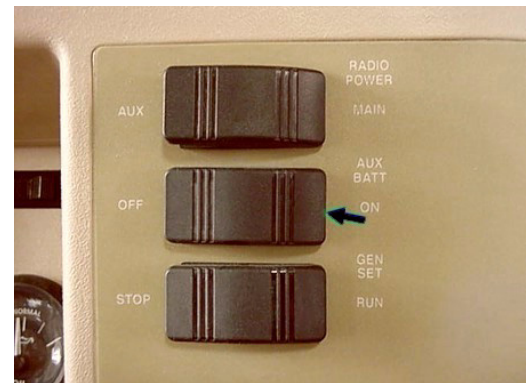

Aux. Batt. Switch
(on dash)

BATTERY ACCESS

The batteries are located on slide-out trays in the battery compartment on the outside of the coach.

Lift the retainer catches that hold the battery tray and slide it outward for service.



House Batteries

Chassis Batteries



Lift Battery Tray Retainer Latches

BATTERY CARE

Lead -acid type batteries are electro-chemical devices for storing and releasing electrical charge. As such, they are simply an electrical reservoir, not an electrical source. As soon as energy is removed from the battery, it should be replaced by the engine alternator or the RV converter system.

If a battery sits unused for 30 days or more, especially during warm weather, it can develop a deposit of sulfate crystals on the metal plates inside the battery. This condition is called 'sulfating' and prevents the battery from either releasing or accepting a charge. If this condition occurs, the battery must be replaced.

If a battery does not contain at least 80% charge during freezing temperatures, the electrolyte can freeze and crack the battery case.

The two best defenses against sulfating and insufficient charge are to:

1. Turn off the Auxiliary Battery switch to avoid parasitic discharge (the trickle discharge caused by directly connected components like LP gas detectors or digital clock displays, etc.), and
2. Check the battery and recharge as necessary at least once a month during long storage periods. Turn the Aux. Batt. Switch off to avoid electrical arcing when attaching or detaching charger clamps.



WARNING

California Proposition 65 Warning:

Battery posts, terminals and related accessories contain lead and lead compounds, chemicals known to the state of California to cause cancer and reproductive harm. Wash hands after handling.

NOTE: We do not recommend leaving the shoreline plugged in continuously during storage periods because the batteries can lose electrolytic fluids and become damaged from continuous charging without periodic use or maintenance.

We recommend following regular battery inspection and maintenance, especially in cold weather.

Further precautions:

- Remove the battery from the coach.
- Store it in a cool place on a wooden or rubber pad to inhibit conductive transfer.
- Check the state of charge periodically to avoid discharge or sulfating.
- To ensure that the battery will always accept and hold a charge, follow these simple maintenance practices.
- Make sure the batteries always remain securely clamped in the battery tray.
- Make sure battery cable clamps are tight on the terminal posts and are free of corrosion.

- Neutralize corrosion buildup or acid film on top of battery by washing with a baking soda/water solution. Rinse with clear water.

NOTE: Make sure vent caps are on securely to prevent baking soda solution from entering the battery and contaminating the electrolyte fluid.



WARNING

Before removing any battery cables or battery, make sure all 12-volt equipment in the motor home is off and the power cord has been disconnected.

Be sure to replace the battery terminal boot back onto the positive terminal after servicing. Care must be taken to avoid pinching the cable between any metal parts. Should the cable be damaged, a short circuit could result in personal injury or damage to equipment. Replace any damaged cables at once. Always remove jewelry and wear protective clothing and eye covering when checking or handling batteries.



WARNING

To prevent wiring damage, it is essential when replacing the cables on the battery, or when using a “booster” battery, that the positive post and the positive cable be attached and the negative post and negative cable be attached. The posts are marked (+) plus and (-) minus.

If a “boost charger” is used while battery is in the motor home, disconnect both battery cables before connecting the charger to avoid damage to engine electronic components.

Never attempt to charge or boost a frozen battery.

- Clean and tighten battery terminals and have the specific gravity checked at least once a year.
- Every two months, or more often in hot weather, check the battery fluid level. Fill to approximately 3/8 inch above the plates. **DO NOT OVERFILL.** If fluid is added during freezing weather, the motor home should be driven several miles to mix water and electrolyte to prevent freezing.
- Fluid level check may be omitted if equipped with maintenance-free batteries.

12-VOLT FUSES AND CIRCUIT BREAKERS

All 12-volt circuits and equipment in the coach area of the motor home are protected by a circuit breaker panel. When a circuit is overloaded or a short develops in any part of the system, a breaker will shut down that circuit. If this happens, turn off all affected lights or appliances and reset the breaker.

A label on the panel states the amperage rating and circuit protected for each breaker.

The House 12-Volt Breaker Panel is located behind the small cabinet door near the galley or under the bed.



House 12-Volt Circuit Breaker Panel - typical*

*Typical view of breaker panel. Actual breaker location may vary according to floorplan. Breakers are labeled on panel.

SECTION 7 PLUMBING

FRESH WATER SYSTEM

The fresh water system provides water to the galley sink, shower, bathroom lavatory, toilet and water heater. Water may be supplied by either of two sources:

- a water tank located within the motor home, or
- any external water source to which the motor home may be connected, known as “city water”.



Water Service Center

Fresh Water Tank Filling Procedures:

Always fill the fresh water tank at an approved potable water filling facility or a known purified drinking water source.

The tank may be filled either by gravity fill or by pressure filling through the city water connection. A special diverter valve will route the water from the hose either directly to the water lines for city water hookup use, or to the fresh water tank for filling.

Gravity Fill

Insert the water hose into the fill opening and turn the city water supply on. The tank is full when water flows from the tank vent tube beneath the coach.

The gravity fill is located behind a small, lockable door on the sidewall toward the back of the coach.



Water Tank Gravity Fill
(typical)

Pressure Fill from City Water Connection

1. Attach hose to city water connector.



Fresh (City) Water Inlet

2. Open the Gravity Fill door to provide adequate air venting and avoid pressure buildup.
3. Turn the Fresh Water Valve inside water service center to Tank Fill position



4. Turn city water supply on.
5. Tank is full when water flows from tank vent tube beneath coach.
6. Turn off city water supply and disconnect from city water connector.
7. Turn Fresh Water valve to Normal position to use the water demand pump. *The Tank Fill position is only for pressure filling the water tank from the city water hose connection*



City Water Use

Connect hose to city water connection as described in previous steps. Turn Fresh Water valve to Normal position and turn demand water pump switches OFF.

NOTE: Always keep the tank fill valve in Normal position unless you are filling the tank. If this valve is left in the Tank Fill position while using the city water, water will keep flowing into the tank and out the tank vent tube onto the ground and the water pump will run without delivering water to faucets.

When connected to an outside source of water, the water bypasses the demand pump and storage tank and supplies pressure directly to individual

faucets and toilet. A check valve built into the pump prevents water from entering the pump and filling the storage tank.

*NOTE: Because city water pressure varies from location to location, we recommend using an **in-line water pressure regulator** to prevent damage to any components, connections and seals in your fresh water system.*

*A water pressure regulator may be obtained from any well stocked RV dealership retail center and some retail discount centers. These devices simply connect in-line between the supply hose and the city water input on the coach. We recommend a regulator that controls water pressure to **40 psi maximum**.*

To Disconnect from the City Water source:

1. Turn the city water source off.
2. Open a faucet inside the vehicle to relieve line pressure.
3. Disconnect the hose from the vehicle and replace the cap on the city water connection.

WATER PUMP

When your coach is not connected to a city water supply, water is supplied from the fresh water tank by a water system demand pump. A demand pump is designed to run only when you are using water. When you open a faucet, the water line pressure drops and the pump begins to run, and it will continue to run as long as the faucet is open. When you close the faucet, the line pressure backs up to the pump, and it shuts itself off.

The pump is self-priming and will run briefly to build up line pressure when the Water Pump Switch is first turned on. See “Initial Water Line Priming” for instructions on using the water system for the first time.

Further Information

See the water pump manufacturer’s operation, care and maintenance information in your Owner InfoCase.

Pump Strainer

The pump is equipped with a cleanable strainer to capture any possible tank borne particles that could damage pump components.

NOTE: We recommend that you check and clean the strainer after each tankful of water during the first few uses of the water pump system. Thereafter, remember to check it at least yearly, such as during winterization procedures.

Unscrew bowl and remove to clean strainer



Water Pump Strainer

To Clean Pump Strainer

Be sure all water pump switches are OFF.

- Twist the inlet cap (bowl) counterclockwise to unscrew from the strainer assembly.
- Remove the bowl and pull the strainer screen out of the bowl to tap out any particles and rinse clean.
- Insert the strainer screen back into the bowl, then screw the bowl back onto the strainer assembly.

NOTE: You must also empty the strainer when winterizing your coach to avoid water freezing and cracking the filter bowl.

Water Pump Switch

Water pump switches are located on the systems monitor panel and in the water service center. While the switch is in the “ON” position, the pump will automatically supply water pressure as it is needed. It is recommended that

the pump switch be turned off whenever you are away from the vehicle or not using the water system. A slow leak in a faucet could drain the water system and discharge the coach battery.

Initial Water Line Priming

1. Make sure that all water drain valves are closed, including water heater valve.
2. Turn water pump switch to “OFF” position.
3. Fill water tank.
4. Open all faucets, hot and cold.
5. Turn on pump switch.
6. Close each faucet as it begins to deliver a steady stream of water (close cold water first). Leave hot water faucets on until they also deliver a steady stream of water. This will ensure that the water heater is filled with water.
7. Check to be sure pump stops soon after all faucets have been closed.
8. Pump is now ready for automatic operation. Pump will start when a faucet is opened and stop when the faucet is closed.

WATER PURIFIER SYSTEM

The water purifier system uses a flow-through activated carbon filter that removes chlorine and other impurities, resulting in clean, taste-free and odorless drinking water.





Water Filter Assembly
below Galley Sink

Replacing The Water Filter Cartridge:

Replace the filter cartridge when water flow from the purifier faucet is too slow for convenience.

- Place a container beneath the filter to catch any remaining water during removal.
- Raise the valve handle near the top of the filter base to block water flow to filter.
- Twist the filter cartridge counterclockwise about a quarter-turn and pull it down and out of the filter head.



- Insert a new water filter cartridge up into the filter head as far as possible and turn it clockwise a quarter turn.
- Lower valve handle to lock filter and restore water flow.

See also “Winterizing Procedure” in this section to prepare the water purifier for freezing conditions.

DISINFECTING FRESH WATER SYSTEMS ON RV'S

(As approved by the U.S. Public Health Service)

To assure complete disinfection of your fresh water system, it is recommended that the following procedure be followed on a new system, one that has not been used for a period of time, or one that may have become contaminated. This procedure is also recommended before long periods of storage such as over winter.

1. Prepare a chlorine solution using 1 gallon of water and 1/4 cup of household bleach (sodium hypochlorite solution). With tank empty, pour chlorine solution into the tank. Use 1 gallon solution for each 15 gallons of tank capacity. This procedure will result in a residual chlorine concentration of 50 ppm in the water system. If a 100 ppm concentration is required as discussed in item 3, use 1/2 cup of household bleach with 1 gallon of water to prepare the chlorine solution. One gallon of the solution should be used for each 15 gallons of tank capacity.
2. Complete filling of tank with fresh water. Open each faucet and run the water until a distinct odor of chlorine can be detected in the water discharged. Do not forget the hot water taps.
3. Allow the system to stand at least 4 hours when disinfecting with 50 ppm residual chlorine. If a shorter time period is desired, then a 100 ppm chlorine concentration should be permitted to stand in the system for at least 1 hour.
4. Drain and flush with fresh water.



WARNING

Chlorine is poisonous - recap bottle and clean utensils after use.

SHOWER HOSE VACUUM BREAKER

After using the shower, you may notice water dripping from the shower faucet assembly. The dripping results when vacuum in the shower hose (after closing the shower faucet) slowly releases and allows water remaining in the hose to drain down. This is a normal function of the shower valve assembly and is not a leak or defect.

The International Association of Plumbing and Mechanical Officials Standard TSC 21-85 (PAR. 4.3) states:

“Shower heads which incorporate shutoff valves, shall have a minimum “drip rate” of one (1) quart in thirty (30) minutes.”

 CAUTION
If items are placed into the shower tub before shower valve vacuum release is complete, they may become wet.

EXTERIOR SHOWER

The exterior auxiliary shower is located in the water center compartment. This feature allows you to do things such as rinse off sand or salt after a swim, rinse off muddy boots, or bathe your pet outside the coach.



Exterior Shower

TOILET

The toilet in your motor home is very similar to the household type, except that it is designed to use only a small amount of water per flush. It uses a high velocity jet of water, producing a swirl effect, to efficiently cleanse the bowl.

Important “Don’ts”

- Don't use facial tissue or regular toilet tissue in the RV toilet. These will not disintegrate sufficiently and will often cling to the sides of the holding tank. Toilet tissue made specifically for use in RV toilets and holding tanks is available at most RV supply centers.
- Don't dispose of sanitary napkins or other non-dissolving items in the toilet.
- Don't put automotive antifreeze or caustic chemicals, such as laundry bleach or heavy detergents into the toilet or holding tank. These products may damage plastic or rubber parts in the system.

Further Information

Please refer to the toilet manufacturer's information provided in your Owner InfoCase for operating and maintenance instructions.

WASTE WATER SYSTEM (HOLDING TANKS)

The drainage system is self-contained and uses two separate holding tanks to contain the waste water until it can be dumped at an appropriate waste water disposal site. This means you can use the toilet, sinks and shower even in areas where utility hookups are not available.

The waste drain (sewer) hose has a handle and valve as a sanitary convenience feature. The handle makes the hose easier to carry when placing into a dump site receptacle and when rinsing and storing. The valve end reduces the chance of dripping from the hose.

NOTE: The dump valve drain outlet swivels downward when necessary to avoid bends in the drain hose which could trap

solids while dumping or to provide more direct drainage while using on-site sewer hook-ups.

Dumping Holding Tanks

1. Remove the dust cap from the drain outlet and connect the sewage drain hose. Twist to lock the hose end hooks onto the pegs on the drain outlet. Be sure it is firmly attached.

NOTE: The dump valve drain outlet swivels downward when necessary to avoid bends in the drain hose which could trap solids while dumping or to provide more direct drainage while using on-site sewer hook-ups.

2. Open the hose end valve (handle) and place the head of the sewer hose into the disposal opening. Push the handle forward to open the valve inside the hose head



NOTE: If the hose end valve (handle) is closed while pulling the hose to the disposal opening, a vacuum lock condition will develop which prevents the hose from extending fully.

Do not open the holding tank valves until the hose valve is open. If you open the

dump valve before the hose valve, the hose will fill with sewage water and be difficult to move or could cause the hose to clog.

3. Open the sewage tank valve (black handle) with a quick pull. Move hose gently about to dislodge any waste and to ensure complete drainage. Close the valve as soon as the tank is empty.

NOTE: DO NOT OPEN BOTH VALVES AT ONCE. Do not open the grey tank valve until the black tank is drained and dump valve closed to avoid sewage back-up into grey tank. Grey water also rinses any black water solids from the drain hose.



Holding Tank Valves (Typical)

NOTE: Black and Gray tank valve positions may be reversed depending on floorplan and tank location.

4. Open waste water dump valve (gray handle) with a quick pull. Close valve handle as soon as tank is empty.
5. After both tanks have been drained, flush the black water tank as described in 'Flushing Your Black Water Holding Tank' following this procedure. (If hose is not available, run several gallons of water into the sewage tank through the toilet. Then open sewage dump valve and drain the tank again. Close valve when done.)
6. Close hose valve by pulling handle up until lock snaps into place.

- Rinse end of sewer hose thoroughly with water and stow.



NOTE: If the hose will not collapse while storing, open the hose end valve (handle) to release air trapped inside the hose.

- It is advisable to add an odor control chemical to the sewage holding tank. These chemicals are available at most R.V. stores.

NOTE: We recommend that you dump all holding tanks before traveling to avoid carrying unnecessary weight.

Flushing your Black Water Holding Tank

The black water holding tank is equipped with an internal spray head that allows you to rinse the inside of the tank with a shower of clean water after dumping.

- Dump your black water holding tank in the usual manner at an approved sewage disposal station.
- Leave black water dump valve open while flushing tank.
- Attach a garden hose from a city water hydrant to the Black Waste Tank Flush Inlet fitting in the water service center. (This inlet is clearly marked separate from the Fresh Water Inlet.)



- Turn the water on to begin flushing; allow water to run for about three minutes.
- Disconnect hose from flushing system fitting and close dump valves.

Using On-Site Sewer Hook-Ups

The drain hose may remain attached to the dump outlet and be routed out the flipdown hatch in the bottom of the compartment while the motor home is parked and connected to an on-site sewage hook-up.

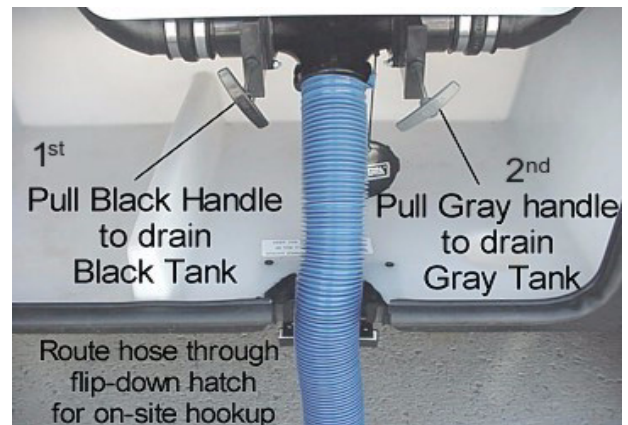

The center outlet section may be swiveled downward for better hose alignment and drainage.

NOTE: Always keep service access passage closed while utility connection is not in use.

When using a sewer hook-up, keep the dump valves closed until a tank becomes full or when preparing to leave the site. This keeps the solids in suspension, allowing them to be carried out

with the liquids when the dump valve is opened. If the valve is left open, the liquids will drain off, leaving solids in the tank. Should this accidentally happen, disconnect the hose, fill the tank about half full with water, and drive a few miles to dislodge the solids. A few starts and stops will aid in the process. Then reconnect the hose and drain in the normal manner.



UTILITY LIGHT

A lamp is located up on the left sidewall to provide light in the water service hook-up area.

The switch is located inside the water service compartment on the left side of the coach.



Utility Light Switch

- Open both Hot and Cold water line valves.
- Turn Fresh Water Valve to 'Tank Fill' position.
- Pull the handle to drain the water tank.
- Push to close immediately after draining to avoid entrance by insects or blown debris.

To Drain Water Lines



Valve Open (Drain Tank)



Valve Closed

WATER DRAIN VALVES

The water drain valves are used to drain water from the water tank and the water supply lines when preparing the motor home for storage or when sanitizing the water system.

To Drain Water Tank:

The fresh water tank drain valve is operated by pulling on a T-handle located in an exterior storage compartment on the right hand side of the coach.

The water line drains are in various areas depending on model. These are standard 'ball valves' which are open when parallel to the line (in-line) and closed when perpendicular (at a right angle) as shown.

See the following photos and descriptions for locations of the drain valves.



Water Line Drain Valve in RH Exterior Water Pump Compartment



Water Line Drain Valves in Water Center



Water drain valves located behind access panel

Water Heater Drain Plug

The water heater drain plug is located on the outside of the coach behind the water heater service panel. Use a socket to remove the plug.

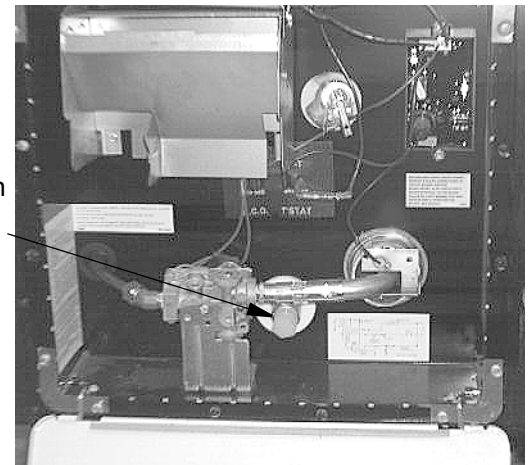

Drain Plug

Water Heater Service Access

WINTERIZING PROCEDURE

Blow Out Procedure

1. Level the motor home and drain the entire plumbing system as described in the following steps.
2. Open water line drain valves and drain fresh water tank. (See Water System Drain Valve Locations chart for locations of drain valves.)
3. Open the Exterior Wash Station shower knobs and lay shower head on ground to drain any water left in the shower line. Also place the tip of your finger into the city water inlet and gently press the backflow valve “button” in the center of the inlet to drain any water trapped in the inlet line.



4. Remove the filter cartridge from the water

filter assembly below the galley sink.



Water Filter Assembly
below galley sink

- Raise the valve handle on the filter base.
- Twist the filter cartridge counterclockwise about 90° and pull it down and out of the filter base.



- Place a container beneath the filter base and lower the valve handle to drain any water remaining in the filter lines.
5. Install the antifreeze diverter plug.
 - Raise the valve handle on the filter base.
 - Hold the diverter by the support bar as shown and guide it up into the filter base.

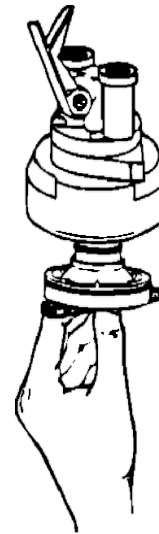

- Push the diverter up into the head as far as possible and turn it clockwise approximately 90° until it stops.
- Lower valve handle to lock the diverter plug in place.

NOTE: Before using again:

- Flush out the system with the diverter in place.
 - After the system has been thoroughly flushed, remove the diverter and store for future use. The diverter plug is intended for winterization only.
 - Install a new water filter cartridge.
6. Turn on water pump and open all sink faucets and shower head knobs. Leave open after water stops flowing.
 7. Press the toilet flush pedal and hold until water stops flowing in the toilet. Then turn water pump switch off.
 8. At this time, if your coach is equipped with an optional refrigerator ice maker, dishwasher or washer/dryer, the water lines for these appliances must also be drained. Instructions are included at the end of this section. If not, proceed to the next step.
 9. Turn off the water heater power switch before draining the water heater tank to avoid damage to the heating element. Drain the water heater by removing the plug from the base of the water heater tank, accessible from the outside of the coach. (Requires socket and ratchet.)



Water Heater Drain Plug
Remove with socket.

Also open the Pressure-Temperature relief valve at the top right portion of the tank to prevent air locking in the tank while draining.



Lift handle only when water heater is cold

10. After water has stopped draining at all faucets and drain valves, leave faucets open and connect a “blow-out” plug to the city water connection on the coach. Then use a compressed air hose regulated to 30 psi or less to force air through the system. (A “blow-out” plug can be purchased at any Winnebago or Itasca dealer. P/N 701705-01-000.)

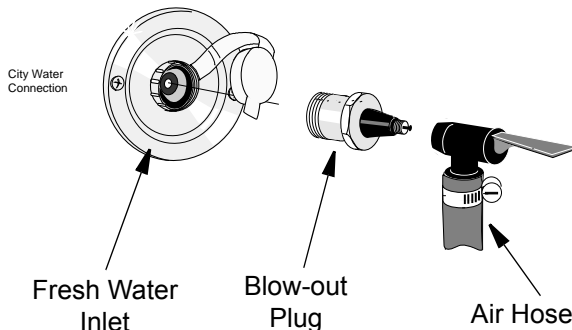

⚠ CAUTION

Limit air pressure to 30 psi to avoid damage to pump or water lines.

NOTE: DO NOT burst air into the system. This can damage the water pump. It is better to let air in slowly.

11. Let air flow for five minutes until water is completely drained out of faucets and drain valves. Then close faucets one at a time.
12. Operate and hold toilet flush lever until water is completely drained from toilet.
13. Turn air pressure off and disconnect water purge adapters. Recap the city water connection to avoid contamination by dirt or insects.
14. Follow procedure listed in “Final Steps...”

Water System Antifreeze Procedure

NOTE: As an alternative to totally draining the plumbing system, you may winterize tanks and lines by pumping non-toxic RV antifreeze through the system. This product is available from your dealer and from most RV supply stores. Follow directions on the container to determine the correct amount to use for your coach.

Your coach is equipped with a manually operated water line winterization system for your convenience in winterizing fresh water lines.

The system features a diverter valve with suction tube to draw non-toxic RV water system antifreeze into the water lines. There is also a water heater bypass valve to avoid filling the water heater with antifreeze. This feature is located near the water pump in the water center or utility compartment.

⚠ CAUTION

Leave Bypass valve handle in 'Normal Operation' position if draining water and blowing out water lines. Place in 'Bypass' position ONLY when using antifreeze solution in water lines.

⚠ WARNING

NEVER use automotive antifreeze/coolant in your RV water system. Auto antifreeze contains ethylene glycol which, if ingested, can cause blindness and can be fatal.

- Turn Winterization Valve 1 to *Water Heater Bypass* position



By-pass Valve Location

On water center main panel.

- Remove and save the protective cap from the end of the antifreeze draw tube (Winterization Valve 2 in water service center)



RV Antifreeze Draw Tube in water center or near water pump (insert into container of RV water system antifreeze)

- Insert the end of the draw tube into a pail or other container with 2 to 3 gallons of non-toxic RV antifreeze solution.
- Turn the handle to 'Wintertize' position.



Winterization Valve in water service center

- Turn the water pump switch on.
- Open each hot and cold water faucet handle in the coach one at a time until antifreeze solution just begins to flow from the faucet; then close.

When Done Adding RV Antifreeze:

- Turn water pump switch off.
- Turn the Winterization Valve 2 to Normal. This will stop the flow from the suction tube and revert the tank line flow to the pump.

- Replace the protective cap onto the end of the suction tube to keep out insects and debris when not in use.

Dump and Clean Holding Tanks

- Completely drain the sewage and waste water holding tanks at an approved waste disposal site. Drain the sewage tank first so the following waste water can rinse any waste solids from the dump outlet and sewer hose.
- Flush the sewage tank using the Black Waste Tank Flush Inlet.
- Close dump valves and refit the dust cap onto the drain outlet.

Final Steps for “Blow-Out” or “Water System Antifreeze” Procedure

1. Close all drain valves and faucets to avoid contamination by dirt or insects. Reinstall water heater drain plug and close P-T relief valve.
2. Pour about one cup of non-toxic RV antifreeze into the kitchen sink drain, bathroom sink drain and shower drain. This prevents any holding tank odors from entering the coach during storage.

NOTE: It is not necessary to add antifreeze to the toilet since the flush valve will be closed.

Do not add automotive antifreeze or caustic chemicals such as bleach or laundry detergents into the toilet bowl or holding tanks. Although these products may have a deodorizing effect, they may damage plastic and rubber parts in the system.

3. Place a bucket beneath the sewage drain valve outlet and re-drain the sewage and waste holding tanks of any clean water that may have entered during the “blow-out” procedure.
Close dump valves to prevent valve shafts from rusting and to prevent entry by rodents and insects. Refit the dust cap onto the drain outlet.
4. Empty the water pump strainer filter bowl to avoid water freezing and cracking the filter

bowl. Strainer is shown previously in this section.

Your drainage and fresh water systems are now totally winterized.

WATER SYSTEM DRAIN VALVE LOCATIONS	
SYSTEM	DRAIN VALVE LOCATIONS
Water Lines:	<p>One (1) valve near the water pump in a storage compartment on the right side of the coach. Two (2) valves in the bottom of the water center compartment.</p> <p>Open exterior shower faucet and lay shower head on ground. Also, to drain any water left in the city water line, place the tip of your finger inside the fresh water inlet and gently press the backflow valve (small “button” in center of connector).</p>
Water Tank:	One (1) T-handle valve in an exterior compartment on the right (passenger side) of the coach.
Water Heater:	Drain plug on outside of coach, behind service door. (Location varies by model.) Use socket to remove drain plug.
Winterization Valve 1: (Water Heater By-Pass)	On water center main panel.
Winterization Valve 2: (RV Antifreeze)	Valve with clear vinyl siphon tube is located near the water pump in a storage compartment on the right side of the coach.

SECTION 8 ENTERTAINMENT

VIDEO CONTROL CENTER

The video selector system allows you to switch the antenna, cable TV, satellite TV system or VCR/DVD signal to any TV set location in the coach.

This means one person can watch a ball game coming in on the roof antenna on the bedroom TV while another person watches a satellite or cable TV program or video on the front TV. Also, two people can watch different programs on the two TV's while taping a third program on the VCR.

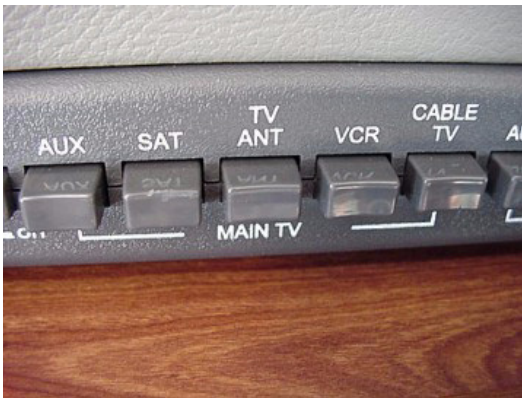

Video Control Center Settings To Watch Broadcast TV (Antenna)

- Press TV ANT button on MAIN TV section of Video Selector Panel.

To Watch Cable TV

- Press CABLE TV button on MAIN TV section of Video Selector Panel.

To Watch Satellite TV (Dish)

- Press SAT button on MAIN TV section of Video Selector Panel.

To Listen to Dash Radio/CD through Surround Sound Speakers

- Press Speaker Switch to RADIO position.
- While driving - press Radio Power switch to 'Engine' position.

- While parked (with key off) - press Radio Power switch to 'House' position.
- Turn Radio On and adjust volume.

FRONT TV IGNITION SWITCH INTERLOCK

If your coach is equipped with a front overhead TV, it is plugged into a special electrical outlet with a built-in ignition switch interlock. The device allows the TV to operate only when the ignition key is in the Off position.

DVD/VCR COMBO PLAYER AND HOME THEATER SURROUND SOUND



DVD/VCR Home Theater

To Watch TV or Video with Surround Sound:

- Provide 110VAC Power for TV and Video unit (plug Shoreline into a utility power supply - or start the GenSet - or switch the Inverter ON).
- Press Aux Battery switch ON.
- Press Radio Power switch (on dash) to HOUSE position.
- Press Speaker Source Select switch to TV position to activate Surround Sound speakers.
- Turn TV on.

- Press TV/Video button on remote or front of video player to select “Video1” input shown on channel display area of TV screen.



- Turn DVD/VCR power ON.
- Then press one of the SELECT buttons... DVD to watch DVD - or VIDEO to watch TV or VCR.
- See “Video Selector Panel Settings”
- Select channels on TV through the video player channel selector.
- Surround sound volume is controlled using the TV remote.

NOTE: You can also play a CD in the DVD player to listen to music in Surround Sound.

Further Information

For detailed Information on TV and Home Theater System, see Manufacturer’s Information provided in your Owner InfoCase.

DC-AC INVERTER - 600 WATT

The inverter changes 12 Volt DC current into 110 Volt AC current to operate your TV and DVD/VCR Home Theater while traveling or when shoreline hookup is not available. It is also connected to the 110 Volt AC outlet for the bedroom TV and in the cab area.



- The inverter must be switched on to operate.
- Turn the inverter off when not in use to avoid draining the coach.

Further Information

See Manufacturer’s Information provided in your Owner InfoCase for more information.

If your coach is equipped with the optional 2000W inverter-charger, see Electrical Section.

TV ANTENNA

The TV antenna on your motor home can be easily raised, rotated a full 360° and lowered from inside the vehicle by simply turning a crank or directional handle. A built-in signal amplifier designed to strengthen signals, is controlled by a power switch built into the video control center panel.

Operation

See the antenna manufacturer’s operation, care and maintenance information in your Owner InfoCase.

WARNING

Never allow the antenna to touch electrical power lines or any other electrical wires.

CAUTION

Always align directional handle to “DOWN” position before lowering.

Check Antenna Light

The check antenna light will come on for 20 seconds when the ignition switch is turned on to remind you to be sure the TV antenna and/or satellite dish are lowered completely into the roof cradle for travel storage.



“Check Antenna” Light

TV Signal Amplifier

The amplifier power switch is located on the video selection system panel in the video center cabinet above the driver and passenger seats or entertainment center cabinet.

To operate amplifier, turn on power switch.

A red indicator light will glow while the signal amplifier is in use.



Checking Amplifier Performance

The TV signals available to an RV are entirely dependent on its location in relation to the transmitter. Signals may vary from strong to no usable signal at all. We recommend that the TV system be checked out in an area known to have good TV reception.

To check the antenna amplifier, raise the antenna, select a TV channel and rotate the antenna for best picture. Then turn off the amplifier power switch. If the antenna amplifier is working properly, the TV picture will now be degraded (snowy). When you turn the switch back on, the picture should again be sharp.

PORTABLE SATELLITE DISH, CABLE TV AND PHONE HOOK-UPS (INPUT)

The portable satellite dish, cable television and telephone input connectors are located in the shoreline compartment.

The television and phone input lines can be routed through the hatch in the bottom of the compartment so the door can remain shut while connected.



Exterior Input Connections for Satellite Dish, Cable TV and Phone (in Water Center or Shoreline Com-

Front Phone Jack

On rear facing end of the passenger sidewall armrest just behind the copilot seat.



Front Phone Jack



Exterior Connection for Satellite Dish and Cable TV
(In Water Center or Shoreline Compartment)

Rear Phone Jack

In the bedroom, near the nightstand.

Satellite System Wiring

This coach is pre-wired for installation of a digital satellite system (DSS) if your coach was not factory equipped with one. Hookup jacks are located in the left or right front overhead compartment, depending on model. See your authorized Winnebago Industries dealer for proper installation and sealing of roof mounted components.



Interior Connection for Satellite Dishes
(in front video center cabinet)

SECTION 9 FURNITURE & SOFTGOODS



WARNING

Be sure all loose items are secured or stored properly while the vehicle is in motion. Possible overlooked items such as canned goods or small appliances on the countertop, cooking pans on the range, or free-standing furniture items can become dangerous projectiles during a sudden stop.



The clamp knob can be unscrewed and removed to allow you to position the chair as you desire in the living area of the coach.

SWIVEL GLIDER LOUNGE CHAIR

This chair is not equipped with a seat belt and is not intended for seating while the coach is in motion. The chair has a glide-lock mechanism to prevent chair movement while the coach is moving. The glide lock is located behind the seat skirt on the rear side of the seat base mechanism.

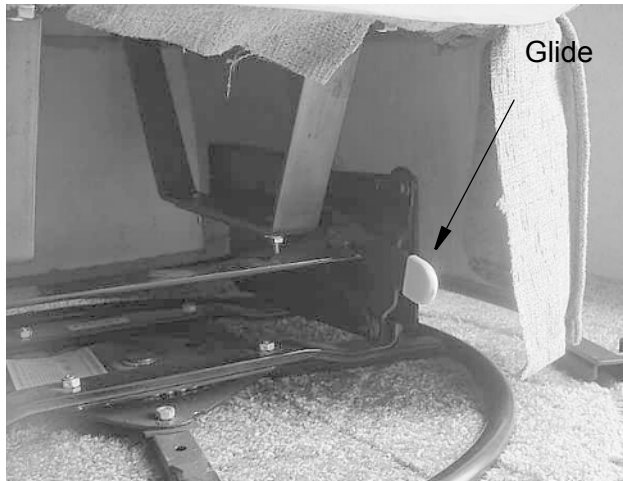

Chair Mount

The hoop base of the lounge swivel-glider is mounted to the floor with a clamp as shown.



CAUTION

The chair must be clamped back into place and the glide mechanism locked before driving the coach.

SLEEPING FACILITIES



WARNING

Do not use sleeping facilities while vehicle is moving.

DINETTE/BED CONVERSION

Dinette to Bed:

1. Lift the seats and remove the seat support 'bumpers' to allow the seats to lie flush for use as a bed. Do not lose bumpers because you must refit them when reverting back to dinette seat configuration.

Remove 'bumpers' from seat frame when converting to bed to allow seat to lie flat. Replace when returning to dinette seating.



2. Release the catch on the table leg brace and fold the leg up against the bottom of the table.



3. Remove the table from the wall support bracket by lifting the end of the table. Then lower the table to rest on the cleats attached to each dinette bench.



4. Arrange dinette cushions to cover bed area.



Bed to Dinette:

1. Reattach the table onto the wall support and lower the table leg.

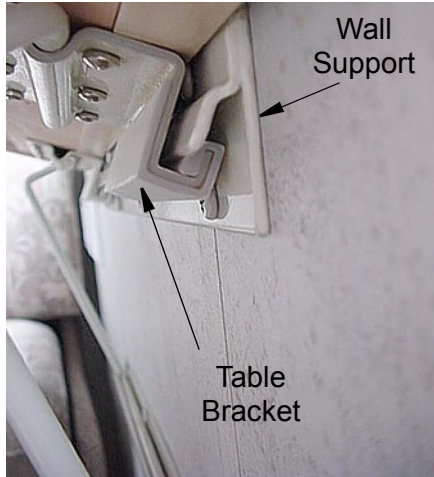

2. Make sure that the table leg is secured into the floor support bracket and the leg brace is locked.



3. Refit the seat support 'bumpers' onto the seat frame.



REST EASY MULTI-POSITION LOUNGE

- Optional



 **CAUTION**

Do not recline the lounge completely flat unless the footrest section is extended.

To Recline: Press the switch on the front of the armrest. Press 'down' to recline; 'up' to return upright.



To Extend Pull-Out Footrest Section:
Squeeze latch behind opening at top of lounge face panel and pull footrest trundle section out until it locks in the fully extended position.



Lift footrest up and away from lounge until it is raised into position.



The gap between the footrest and seat provides ample room to enter and exit the lounge. If desired, however, the footrest can be unlatched and pushed against the lounge seat. The footrest 'drawer' will latch when pulled out completely and must be unlatched to push back in when stowing the footrest.



Tip for "power users": If you have the footrest section unlatched and positioned against the seat cushion, it will move out with the lounge when you press the recline switch. When you

return to upright position, you can hook your heels over the front edge of the footrest section and pull it back with you. Then, when you want to get up, simply push the footrest section forward with your feet to provide a gap for you to exit.

To Convert to Bed: Extend footrest section and push together with lounge seat cushion, then press recline button until entire lounge lies flat. Reverse steps to return to lounge seating.



 **CAUTION**

Do not recline the lounge completely flat unless the footrest trundle section is extended. Do not occupy the lounge when elevating the seatback from the flat bed position to upright lounge position. If house battery voltage is low, the mechanism may require assistance by lifting the seatback while returning upright from flat bed position.

 **WARNING**

To avoid injury to young children, do not allow them to operate the sofa, or to play within the sofa or near the operating mechanism.

NIGHTER PLEATED BLINDS

Your coach may feature opaque pleated shades for nighttime privacy and daytime room darkening purposes.

See section 11 Maintenance for adjustment instructions if the blind will not stay up when raised.

WOOD FURNITURE AND CABINETS

People are drawn to the natural beauty of wood. At Winnebago Industries, our craftsmen work with the art found in each piece of wood to create cabinets of superior quality, backed by the Winnebago Industries warranty.

- Oak is a strong, open-grained hardwood that ranges in color from white to pink and reddish tones. Streaks of green, yellow and even black may appear due to mineral deposits. Oak may also contain wormholes and wild, varying grain patterns. This distinct graining is considered a desirable quality and has made oak one of the most popular woods used for cabinetry.
- Maple is a close-grained hardwood that is predominately white to creamy-white in color, with occasional reddish-brown tones. While maple typically features uniform graining as compared to other wood species, characteristic markings may include fine brown lines, wavy or curly graining, bird's eye dots and mineral streaks. These traits are natural and serve to enhance maple's natural beauty.
- Cherry is characterized by its red undertones, but may vary in color from white to a deep, rich brown. Cherry is a close-grained wood with fairly uniform texture, revealing pin knots and curly graining. All wood will age with time and the finish will darken. This is especially true for cherry. This is a sought-after quality in cherry cabinetry, and those who select it expect this evolution.

No matter which species you choose for your new Winnebago Industries motorhome cabinetry, please keep in mind that no two pieces of wood are exactly the same.

Stains are likely to exaggerate the difference between open and closed grains and other markings in wood. Grain variation and color change should be expected. As hardwood ages, it will darken when exposed to different types of light. Color differences or changes in wood can also be caused by exposure to harsh chemicals, extreme heat or other contributing external conditions.

Any color change that occurs in both the finish and the wood is considered part of the natural aging process and is not to be considered defect or damage.

Additionally, wood species exhibit other defining characteristics, such as mineral deposits/streaks, knots, sap runs, pin holes and wormholes. These markings make the wood unique and contribute to its enduring beauty.

Therefore, since wood is a product of nature and will have certain natural characteristics and variances they are not covered under the warranty.

SECTION 10 SLIDEOUT ROOMS

SLIDEOUT ROOM EXTENSION

CAUTION

Release slideout room travel strap before attempting to extend slideout room.
Fasten travel strap before driving vehicle.
See the following instructions.

Your coach is equipped with slideout room extensions to enlarge your living areas at the push of a button. The slideout rooms extend and retract by hydraulic mechanisms with an electronic control system.

The lounge slideout switches are located on the lower right dash bezel. Rear slideout switches are located on a wall in the rear of the coach

Note: We recommend that you KEEP THE ENGINE RUNNING WHILE EXTENDING OR RETRACTING SLIDEOUT ROOMS so the engine alternator can provide maximum power for proper operation of the slideout mechanisms.

Travel Strap (Front Slideout Rooms)

The Travel Strap **must be released before extending the room** or damage to the coach will result.

The travel strap is intended only to restrict movement of the slideout room while the vehicle is in motion. They are not designed to withstand the force exerted by the hydraulic extension mechanism and will not prevent extension of the room.

The travel strap is located on the floor near the front of the slideout room.

To Release:

- Pull the strap buckle outward and up to release tension on strap.



- Pull a short length of the excess strap back through the buckle to provide sufficient slack.
- Unhook the strap end from the brackets on the floor and wall edge. Store strap in location of your choice. (Under the couch is one choice.)

To Fasten Strap:

- Hook the strap end into the mooring bracket.
- Flip buckle downward and press toward strap until it “snaps” snugly into place against the strap.



- If a strap is loose or too tight after closing the buckle, adjust tension as needed.

Extending Procedure

 **WARNING**

Keep all persons clear of the slideout room and moving parts while extending or retracting. Do not occupy the slideout room while it is being extended or retracted.

 **CAUTION**

Release slideout room travel strap before attempting to extend slide-out room. Fasten travel strap before driving vehicle. See following instructions.

Check to be sure the exterior storage compartment doors below the slideout room extension are closed before extending or retracting the room to avoid possible damage to the doors.

Before Extending the Slideout Room:

1. Level the coach and set the Parking Brake.
2. If your coach has a luggage compartment beneath the slideout room, make sure that the luggage compartment doors are closed so that they will not interfere with slideout operation.
3. Make sure that there are no people who could be harmed or obstacles that could cause damage due to room extension.
4. Unfasten the safety travel straps inside the coach.

If the slideout room has a couch or other furniture, make sure no people or pets are seated on them until the room has been fully extended.

To Extend SlideOut Rooms:

See “Before Extending the Slideout Room” before proceeding.

- Start the coach engine so the alternator can provide maximum power for proper operation of slideout mechanisms.

- Level the coach and set the Parking Brake. An interlock relay system will then provide power to the slideout control switches.
- Release travel straps (galley).
- Press the Slideout Room switch ‘OUT’ or ‘EXTEND’ and hold until the room is fully extended, then release the switch.
- The front slideout control switches are located on the lower right dash bezel, above the ignition key and park brake knob.



Front Slideout Switches
on dash



Rear Slideout Switch
(on wall in rear of couch - varies by model)

Retracting Procedure

Before Retracting the Slideout Room:

1. Be sure the coach is level and the Parking Brake is set.
2. Check the outside of the coach to make sure there are no people, pets or obstructions near the slideout room.
3. Make sure that there are no people who could be harmed or obstacles that could cause damage due to room extension

4. If the slideout room has a couch or other furniture, make sure no people or pets are seated on them until the room has been fully retracted.

If it has rained recently before you retract the slideout room, we recommend using the hydraulic leveling system to lean the coach and drain off any excess water possibly remaining on the roof before retracting. Lean the coach slightly to the left (driver's side) as shown by raising both right side jacks to let excess water flow away from the rooftop weatherseal and toward the outside of the slide-out roof.

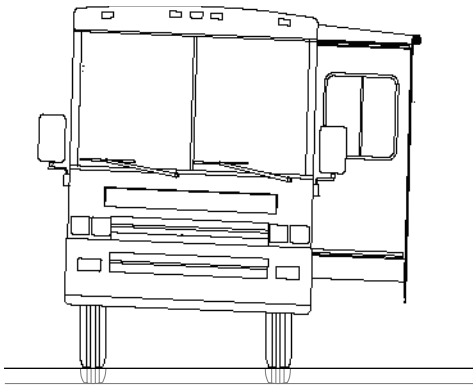

⚠ CAUTION

Although there is an awning over the roof of the slideout room, there is a possibility of debris getting onto the roof. Because the slideout roof is drawn into the interior of the coach when retracted, be sure there is no debris, such as excessive dirt, tree seeds, twigs, leaves, etc. on the roof before retracting.

To Retract Slideout Room:

- Start the coach engine so the alternator can provide maximum power for proper operation of slideout mechanisms.
- Remove all items from the coach living room floor, close cabinet doors and drawers. Be sure there are no items at the end of the bed or behind the driver seat or protruding from

compartments which could be crushed or cause damage to floor covering or cabinets when the room is retracted.

- Press Slideout Room switch 'IN' or 'RETRACT' and hold until room is fully retracted, then release the switch.
- After the room has been retracted, refasten the safety travel straps.

General Slideout Care

- Wipe outer seals occasionally with talc or UV protectant for smooth quiet operation.
- Clean the floors inside before retracting the room to avoid vinyl flooring scratches or carpet pile snags.
- Be sure there are no items at the end of the bed or behind the driver seat or protruding from compartments which could be crushed or cause damage to floor covering or cabinets when the room is retracted.
- See your authorized dealer for regular maintenance and service of the mechanism and hydraulic system.
- See the Leveling System/Room Extension Operator's Manual in your Owner InfoCase for maintenance information.

**SLIDEOUT ROOM
TROUBLESHOOTING**

If Slideout Room Will Not Operate

- The chassis battery may be low on charge. The engine should be running while extending or retracting slideout rooms so the engine alternator can provide maximum power to properly operate the slideout mechanisms. If battery charge is sufficient, go to next step.
- One of the fuses may be blown in the hydraulic system control box on the pump beneath the right front of the coach.



WARNING

Stop engine, place transmission in neutral position and apply parking brake before lying beneath vehicle for this procedure.

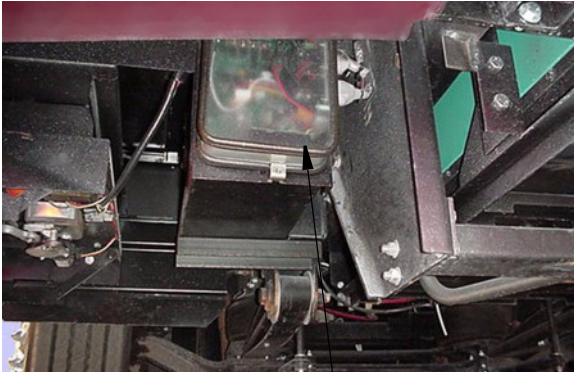

Hydraulic System Control Box
viewed beneath right front of vehicle

See the Leveling System/Room Extension Operator's Manual in your InfoCase for control box fuse information.

If no fuses are blown, go to the next step.

- If the batteries and fuses are okay, there may be a failure in the hydraulic control system or electrical system which requires service. Retract the room using the following emergency retract procedures and contact your dealer for service.

**SLIDEOUT ROOM
EMERGENCY RETRACTION
PROCEDURES**

**Front Slideout Rooms
Emergency Crank-In Procedure
(If slideout room will not retract using
control switch)**

Step 1 - Relieve Hydraulic Line Pressure

- Open the hydraulic pump slideout solenoid valves to release hydraulic line pressure and let fluid bypass into the fluid reservoir.
- The hydraulic pump is located beneath the entrance steps. To access the pump, remove the nut from the underside of the top step 'lip' and lift the step upward and remove.



Hydraulic Pump Access - remove nut from bolt on underside of step and lift off step



Hydraulic Pump beneath Entry Step

*NOTE: The hydraulic pump is equipped with two types of hydraulic solenoid valves shown. The **leveling jack** solenoids have a **T-handle** on the valve shaft that can be turned by hand. The **slideout room** solenoid has a small 1/4" nut at the end of the valve shaft that requires you to use a 1/4" nut driver built into the shaft of the oil reservoir breather/fill cap.*



Use 1/4" nut driver built into end of pump reservoir cap to open slideout solenoid valves.

See the Leveling System/Room Extension Operator's Manual in your InfoCase for specific instructions on which valves to open for front or rear slideout rooms and what additional precautions to follow.

- Open the slideout solenoid valves (with 1/4" nuts on the ends) to relieve hydraulic line pressure. **DO NOT LOOSEN NUTS MORE THAN 4 FULL TURNS.**



Leveling/Slideout System Hydraulic Pump
(Note valve positions in relation to fluid reservoir)

Use provided 1/4" nut driver to turn nut counterclockwise 4 turns only.

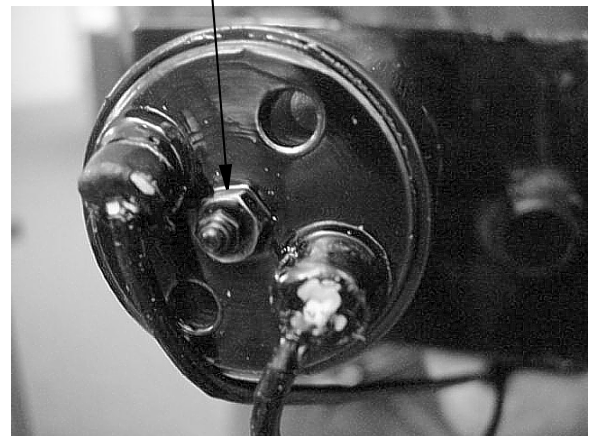

Slideout Room Solenoid Valve

- Do not open any of the four large T-handled valves. These control the coach leveling jacks.

Step 2 - Crank the Room Inward

- A wrench is used to crank the room inward. You may use the ratchet wrench supplied with the coach (in one of the storage compartments) or any type of lug wrench of the same nut size.
- Crank-in bolts are located on the outboard mounting plates of the slideout room as shown. These plates are located at both ends of the room inside the StoreMore™ compartment doors.

- Loosen the locking screws at the crank-in bolt shafts as shown before trying to turn the bolts.

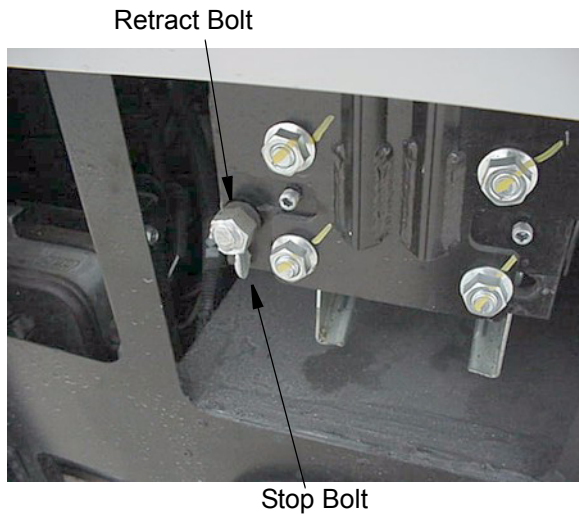

- After loosening the lock screws, fit the ratchet wrench onto the bolt head and begin cranking clockwise slowly a few turns, then alternate to the other side for a few turns. With an assistant using an additional wrench, crank both sides evenly together to speed this process.



Crank the Slideout Retract Bolt with the Ratchet Wrench provided.

- Crank the wrench(es) clockwise slowly, until the room is fully retracted. Allow about 10 minutes to crank room in fully.

NOTE: Attempting to crank the room in too quickly will raise pressure in the hydraulic fluid lines and make cranking more difficult.

 **CAUTION**

The Retract Bolts must be 'backed out' to their original positions immediately after the crank-in procedure to avoid damaging the retract bolts and slideout mechanism the next time the room is extended.

Step 3 - Secure Travel Straps and Close Hydraulic Line Valves

- Fasten the slideout room Travel Straps.
- Close the slideout solenoid valves completely.

NOTE: Close the valves snugly, but do not overtighten. Overtightening may cause internal damage to the valves.

- See your dealer for service of the room extension system before using again.

Bedroom Slideout Rooms - Emergency Push-In Procedure

In the unlikely event that your bedroom slideout fails to retract using the power switch, check for obvious causes first, such as low charge on the house batteries, or a burned out fuse on the chassis fuse block. (See "Troubleshooting" elsewhere in this section.)

NOTE: Check fuses #16 Step Alarm and #24 Radio/Acc. There is also a fuse on the back of the HWH leveling system control pad, which must be unfastened from the driver door to inspect.

'Push-In' Procedure:

- Open the "slideout" hydraulic line valves on the pump to relieve hydraulic line pressure. (See photos on previous page.)
- **DO NOT OPEN THE JACK VALVES ON THE RESERVOIR SIDE OF THE PUMP.** These regulate the coach leveling jacks.

- Apply a steady inward pressure of approximately 150 lbs. to the exterior sidewall of the slideout room to push the room in toward the coach until it is snug against the main coach sidewall.

NOTE: Use some type of rigid, padded material to protect the sidewall from punctures, dents or other damage to the finish from any device or equipment used to press the sidewall in.

- Pressure must be applied evenly to avoid binding of the hydraulic mechanism. It may take about 10 minutes to press the room extension inward completely.
- When the room is snug against the coach wall, close the solenoid valves to prevent “creep out” during transit.

See your Authorized Winnebago Industries Dealer for service of the slideout system before using again.

NOTE: When the system has been corrected, check hydraulic fluid level and refill reservoir as necessary. Press the Retract switch for 15 to 20 seconds before attempting to extend the room. Then run the room out and in several times to purge any air from the hydraulic system. Finally, recheck fluid level and fill as necessary.

Further Information

See the Hydraulic Room Extension operating guide included in your Owner InfoCase for further instructions and troubleshooting information.

CHECKING HYDRAULIC OIL LEVEL

See the Hydraulic Room Extension operating guide included in your Owner InfoCase for complete maintenance instructions and information.

All maintenance should be done as part of the normal servicing of the coach.

The oil level should be checked when the vehicle is first purchased and then once every two years. More often if there is an oil leak in the system.

The hydraulic pump is located under the entrance step.

Jacks and Slideout Positions:

To get an accurate indication of oil level all slideout rooms must be IN

Checking Dipstick:

The oil reservoir is part of the pump/manifold assembly.

The oil level is checked and filled through the breather cap.

Clear any dirt and debris away from the breather/filler cap before removing. The oil level should be between the two marks on the breather cap dipstick shown in the following illustration.

NOTE: The breather cap is located on the top side of the power unit reservoir.

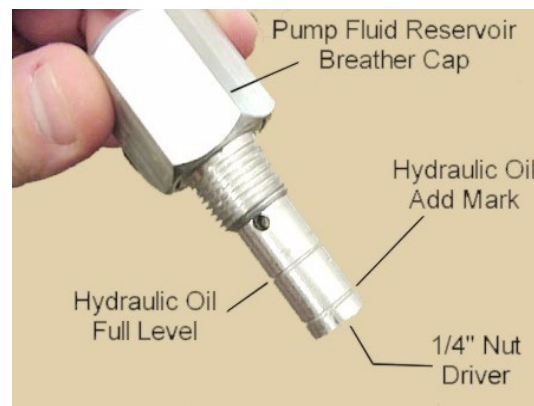

NOTE: Prior to removing the breather cap, either to check the oil level or to use the 1/4" nut driver, clean any debris from the top of the reservoir before returning the breather cap to the reservoir. Remove any paint chips or other debris from the dipstick including debris inside the 1/4" nut driver.

Overfilling the tank can cause leakage of hydraulic oil through the breather cap.

Hydraulic Fluid Recommendation

HWH Specialty Hydraulic Oil is recommended. In an emergency Dexron automatic transmission fluid can be used.

DO NOT USE brake fluid or hydraulic jack fluid. Use of these can damage seals.

NOTE: Dexron automatic transmission fluid contains red dye and can cause staining should a leak occur.

SECTION 11 MAINTENANCE & STORAGE

SEALANTS

Water is a recreational vehicle's worst enemy when it is allowed to enter where it's not intended. Sealants perform a very important function and should be inspected closely and maintained regularly. Winnebago Industries utilizes many different types of sealants.

Sealants, in general, do not have "set" lifetimes. Varying environmental factors affect the pliability and adhesiveness of sealants. You or your dealer must:

- Inspect all sealants, a minimum of every six months.
- Inspect the moldings, windows, clearance lights, compartment doors and all their attachments.
- Check sealants for cracks, voids, gaps, breaks, adhesion, and any sign of physical deterioration.

NOTE: Proper sealant inspection includes not just visual observation but running a finger along sealant seams to verify proper adhesion to the surface. Any loosened areas must be replaced.

- Have the sealant replaced if you notice any of the above. Your local Winnebago Industries dealer has the correct and necessary parts and experience to help you maintain your sealants. See "Recommended Sealant Application" page at the end of this section.
- Always use the same type sealant that was removed.
- Immediately have dealership check moldings, windows and exterior attachments for leak source if you notice water inside of unit.



CAUTION

Sealants must be inspected every 6 months and replaced if necessary.

ROOF

The roof is made of Thermo-Panel materials like the walls and floor. It will support the weight of an average adult should it become necessary to repair the roof or roof mounted components. It is not recommended, however, that very large or heavy objects be carried on the roof while the vehicle is in motion. (See Section 3 for roof loading specifications.) Always have damage to the roof area repaired immediately. Damaged or detached sealant around the vents, air conditioner, body-to-roof seams, etc., should also receive immediate attention. Delaying these repairs may allow water leakage and result in damage to interior ceiling and body panels, upholstery, etc., which is not covered by the limited warranty.

UNDERBODY

Buildup of mud and dirt under the body can cause damaging rust on steel parts and can add needless weight to the vehicle. This, in effect, reduces the amount of cargo you can carry and remain within GVWR and GAWR limits.

Corrosive materials, such as those used for ice and snow removal and dust control, also accumulate on the underside of a vehicle. These materials should be removed by flushing the underbody regularly with water, especially areas where mud and other foreign materials collect.

NOTE: Anytime an RV technician is beneath the coach or it is on a hoist for service, have the underbody and chassis checked for proper condition, clearance and routing of hydraulic hoses and wires for slideout rooms to avoid kinks or leaks and pinched wires, etc.

EXTERIOR FINISH

The exterior surface of your motor home has an automotive type finish. Frequent washing and thorough cleaning is recommended to prevent damage to the vehicle finish after exposure to damaging salts, calcium chloride, road tar, tree sap, insects and other foreign material. Never wash the vehicle in direct sunlight, while the vehicle surface is hot, or using hot water.

Do not use strong soaps or detergents for washing the motor home. Always use a mild soap in warm water, a commercially prepared product for cleaning automotive finishes or your local car wash. Be careful when using pressure-type washers to avoid loosening exterior decals or sealants, etc.

NOTE: Avoid aiming water flow from a hose or spray from high pressure washing equipment into any appliance intake because damage or difficulty in operating appliances may occur.

After washing the motor home, carefully inspect caulking around window frames and vents and any other joints that may have separated. Recaulking, if necessary, is quite simple. Appropriate compounds are sold at Winnebago and Itasca dealers, and the materials are quickly and easily applied. Also, inspect weather seals around door, etc., and if necessary have a dealer replace them immediately.



CAUTION

Never use a strong solvent such as lacquer thinner, or harsh abrasives on painted surfaces.

Waxing and Polishing

When water will not bead up and roll off the finish of your freshly washed vehicle, it's time to apply a new coat of wax to the finish. Wax not only improves the appearance of the vehicle, but protects the finish against oxidation and corrosive substances.

We recommend using a wax that is compatible with painted and gel-coated fiberglass finishes.

If the finish begins to look dull or discolored, it may need to be cleaned with a polishing or cleaning compound.

NOTE: If you use a polish or a cleaning compound that does not contain a wax preservative, we recommend reapplying a coat of hard wax after cleaning or polishing the finish.

CARE OF DECALS

The pressure-sensitive decals on your coach require very little maintenance. They should be treated like any painted surface on your vehicle. Here are a few helpful hints on caring for decals:

- Wash decals with plain soap and water or any retail car wash soap. Always rinse thoroughly.
- Test any cleaning solution on a small section of decal before using.
- Do Not use any aromatic solvents such as acetone, MEK, toluene, xylene, etc., on decals. Any solvent including alcohol may soften or smear colors.
- Do Not use lacquer thinner on paint or decals. Do Not overcoat decals with clear paint.
- Do Not let gasoline or other fuels drip and stay on decals for any length of time. Rinse immediately.

FRONT END MASKS AND PAINT DAMAGE

If you choose to install an aftermarket protective front end mask, please follow these preventive guidelines:

- The front end mask must be removed if the vehicle sits longer than 5 days without being driven.
- The front end mask must be thoroughly dry before storing away or reinstalling on the front of the coach.
- When reinstalling the mask, be sure both the mask and the painted surface are free of debris to avoid damage by abrasion.

- Failure to follow recommendations will void any paint warranty.

NOTE: This information is to make you aware of a potential paint failure that could occur when moisture is trapped between front end masks and painted surfaces.

HEADLIGHTS AND EXTERIOR LIGHTS

Exterior Light Lenses

Most Winnebago Industries vehicles have polycarbonate lenses on exterior lamps, which are very sensitive to a variety of chemical solvents and cleaners.

Use only soap and water to clean exterior lamp lenses - especially headlights!

- Contact with certain chemicals can cause etching, ‘crazing’ or cracking of the lens, which can significantly reduce the lens clarity and effectiveness of the lamp and may require replacement of the complete lamp housing.
- Some popular citric acid cleaners may cause polycarbonate lenses to become ‘hazy’ or ‘foggy’.
- Do not use a pressure washer to clean headlights.
- Inspect and operate the lights regularly to confirm proper operation and mounting condition.

Headlight Moisture

Your coach is equipped with composite headlights which contain replaceable halogen ‘bulb’ elements, common to most current automobiles. This type of head lamp assembly is not sealed from atmosphere and is designed with a moisture venting system.

Because they are not sealed, under ‘dew point’ conditions the headlights may exhibit signs of humidity condensation on the reflector surface and lens, such as small droplets of water or ‘fogging over’.

If this happens, drive with the headlights on so the moisture can evaporate and expel through the venting system designed into the head lamp assembly.

Also avoid aiming high pressure wash sprays directly at the head lamp assemblies.

NOTE: Because RV’s are often parked for long periods, we recommend that you check your headlights periodically for accumulated moisture. If moisture remains on the reflector surfaces or lenses for a long period, it can cause water stain marks or other damage. If there is moisture in the head lamp, the head lamp manufacturer recommends turning on the headlights for several hours or as necessary to evaporate and vent the moisture.

PLASTIC PARTS - CLEANING

Many parts in your motorhome, such as the dash, exterior light lenses, and certain exterior body panels are made of high-impact plastic materials that can be damaged by wiping with solvents or improper cleaning products.

Always try cleaning plastic parts with the mildest cleaners first and work your way up to stronger cleaning products. Use the following cautionary lists as a guide when selecting cleaning products to use on plastic parts.

 CAUTION
<p>DO NOT use citrus based cleaners on polycarbonate finishes. Citric compounds will damage the high-gloss surface causing it to appear dull or ‘flat’. Always test a cleaning product on a hidden area to be sure it will not cause damage to the appearance of the part.</p>

Here is a list of mild cleaners that **may be used safely**:

- Car washing soap and water
- Glass cleaners *without ammonia*
- Mineral oil
- Multipurpose cleaners (such as Fantastik[®], Formula 409[®], etc.)

The following products, compounds or solvents must be **wiped off immediately** to avoid damage:

- Ammonia
- Brake fluid
- Bathroom basin, tub and tile cleaners
- Chlorine
- Ethyl alcohol
- Isopropyl (rubbing) alcohol
- Kerosene or gasoline
- Naptha
- 'Pine' type household cleaners

Do not use cleaners containing the following products, compounds or solvents. These products **will damage** the finish

- Acetic acid
- Acetone (nail polish remover)
- Aromatic solvents (lacquer thinners)
- Benzene
- Butyl alcohol

INTERIOR SOFTGOODS

We recommend a weekly routine of vacuuming all fabrics and carpet throughout the motor home to prevent an accumulation of dirt which can detract from the appearance and shorten the life of carpet and fabrics.

Leather Upholstery

Driver/Co-Pilot Seats & Sofa - (Optional)

The optional leather seats are made of top quality cattle hide soft leather.

- We recommend using a mild soap and water applied gently to the solid areas. Buff dry immediately with a soft cloth to avoid water spotting. Avoid harsh and excessive rubbing while cleaning. Soft leather needs delicate care.
- Never use harmful substances (e.g. stain removers, solvents, saddle soap, shoe polish or other unsuitable fluids) on soft leather. Cleaning and touch-up kits specifically formulated for leather upholstery are available from most fine furniture dealers.

Fabric Upholstery

Some fabrics used in this motor home may contain fire retardant and fade resistant additives which can be damaged by use of improper cleaning products. Some water-based household cleaning products are not formulated for use on fabrics and may cause excessive shrinkage or fading. Always test any cleaning product on a hidden area of fabric before using on visible areas. For best results, fabric cleaning should be referred to a professional carpet and upholstery cleaner.

NOTE: To minimize fading of upholstery, carpets and other interior fabrics caused by excessive sunlight, the drapes, blinds or shades should be closed when the motor home is parked for an extended period of time.



WARNING

When cleaning upholstery and fabric, do not use lacquer thinner, nail polish remover, laundry soaps, or bleach. Never use carbon tetrachloride, gasoline, or naptha for any cleaning purpose. These materials may cause damage to the material being cleaned and most are highly flammable.

Vinyl Fabrics (including ceiling)

Vinyl should be cleaned with a soft, damp cloth, and a mild detergent only. Do not use solvents. Solvents may damage the surface of the vinyl.

Draperies, Curtains and Bedspreads

These items may be woven from a variety of fabrics. We recommend that these be professionally dry cleaned only. A five percent shrinkage may occur when you have these items dry cleaned.

General Stains

As with any stain or contamination, the quick response is the best, especially when done in conjunction with the proper cleaner for the type of stain.

CABINETRY

Wooden items may be cleaned with a soft cloth and a good quality wood finish cleaning product.

Vinyl simulated wood panels may be cleaned with a mild, water based cleaner and a soft cloth. Do not use solvents on vinyl wood panels.

NOTE: Many cabinetry and furniture items throughout this motor home are constructed either partially or completely of real hardwoods. Because of natural variations in woodgrain density, slight differences in stain hue may exist between one item and another. This is the distinctive character and beauty of real wood.

VINYL WALLBOARD

Decorative vinyl covered wallboards may be cleaned with a mild solution of water and isopropyl (rubbing) alcohol or a mild soap solution. Do not use solvents or abrasive cleaning products.

CARE AND MAINTENANCE OF YOUR SOLID SURFACE COUNTERTOP

You can easily maintain the beauty of your countertop with little effort, under most circumstances, using a window spray cleaner, warm soapy water or other general purpose spray cleaner. You can also use liquid or gel-type cleaners containing bleach. Because the material is nonporous, stains cannot penetrate below the surface and will nearly always disappear using these cleaning methods.

If a stain has dried on, allow the cleaner or soapy water time to soften the area, after which the stain will wipe off.

If the stain is not water-base or oil-base material, you may need to gently remove it using a plastic scraper (disposable plastic knife for example) followed by normal cleaning methods described above.

You may want to scrub the entire surface periodically. Do this lightly and evenly with a mild abrasive powdered or liquid cleaner.

Always use a cutting board rather than slicing foods directly on your countertop. The underside of one of your sink covers will provide an easily accessible cutting surface. This will keep your countertop looking its best and minimize care efforts. (An occasional sanding with a medium grade (120 grit) sandpaper will remove any cut marks accumulated on the sink cover bottom).

To remove cuts and scratches, use a more aggressive cleaning powder such as Comet, a moistened steel wool soap pad or green scouring pad. We recommend that you finish the entire surface using the same cleaning material and scrubbing method to maintain a uniform appearance.

If you prefer a glossier look, follow up with a good quality furniture polish or a liquid automotive wax (non-cleaner type).

Use trivets and 'hot pads' under hot cooking pans. Do Not set hot pots or pans directly from the stove or oven onto the counter. The solid surface material is extremely heat resistant, but sudden contact by a very hot material with a cold countertop surface could cause a crack that would need to be repaired. Likewise, concentrated high heat sources in a small area, such as a crock pot or an electric griddle may cause a crack. We strongly recommend using a trivet under these. Also do not allow candles to burn directly on the counter surface.

Avoid paint remover or oven cleaner. The solid surface material is also resistant to most chemical substances but exposure to some harsh chemicals and solvents such as these can cause damage that would need professional repair or

replacement. If one of these materials does spill or drip onto the counter surface, wipe it up immediately to avoid damage.

GALLEY SINK

Care and Cleaning Instructions

The galley sink has been designed and engineered to resist scratches and should not stain under normal household use if used properly.

To keep this product looking its best, we recommend that you take a few easy precautions.



General Cleaning. Rinse all food and beverage residue from the sink as soon as possible. Some food & beverage residues, if left to sit in the sink, may require the use of detergent or an abrasive cleaner.

Hard-to-Remove Food and Beverage Residue. Abrasive cleaners such as Ajax, Comet, Bon Ami or Bar Keeper's Friend, may be used to remove mild stains and for routine cleaning. The use of an abrasive pad such as "Scotch-Brite" will remove most of the tougher stains. For the most stubborn stains, fill the sink about one quarter full with a 50/50 solution of bleach and water. After 10 or 15 minutes of soaking drain solution from the sink as you rinse both sides and bottom. Note: Do not use steel wool or metal scouring pads.

Mineral Based Stains. Cleaners designed to remove iron or rust should not harm the sink, nor will solvents such as denatured alcohol, mineral spirits or acetone.

Marks or Discoloration. White automotive rubbing compound may be used to remove stubborn marks or discoloration. Use of these products will not damage the solid surface. Always follow label directions.

NOTE: Improper use may damage this product and void the warranty.

RANGE AND REFRIGERATOR

For care and appearance maintenance of the range and refrigerator, refer to the operation and maintenance manual for each of the individual appliances included in your Owner InfoCase.

BATHROOM

The tub and shower walls in the bathroom should be cleaned with a mild soap and water solution. Do not use an abrasive cleaner on the shower walls and tub.

The lavatory sink is made of the same composite material as the galley sink. Do not use abrasive cleaners, harsh detergents or solvents. Refer to the Galley Sink - Care and Cleaning Instructions.

For instructions on the care of your toilet, refer to the information in your Owner InfoCase.

DOORS AND WINDOWS

Windows may be periodically cleaned with a good quality glass cleaner or mild soap solution using a soft cloth. Use care when removing ice or frost from the windows. Always use a plastic ice scraper, never one made of metal. Use care when removing ice from the mirrors to protect the reflective surfaces.

Door locks and hinges should be lubricated periodically with powdered graphite to ensure trouble-free operation and to protect against freeze-up.

NIGHTER BLINDS

Tension Adjustment:

The tension of the pleated blinds can be adjusted if they become loose and will not stay up when raised, or they are too tight and are difficult to raise and lower.

To tighten the tension

Wrap the lower end of the guide cords (on each side of the shade) a few turns around the spools at the lower corners of the blinds.



To loosen the tension

Unwrap the guide cords from the spools one turn at a time until desired tension is achieved.

Preserving Shape:

The pleated blinds are made using high quality materials that are designed and woven to retain their shape throughout their useful life. They may lose their crisp shape, however, if left in a lowered position for an extended period of time without being raised periodically. If this happens, the pleats can be restored using this simple method.

- With the blind fully lowered, dampen the entire area of the pleats with a good quality laundry spray starch.
- Raise the blind fully while still damp and let it remain in the raised position for about 24 hours, until the starch has dried and “set”.
- Reapply starch periodically (every few months) as needed.

PREPARING VEHICLE FOR STORAGE

Properly preparing your vehicle for storage will lessen the possibility of damage to your vehicle. Prepare the motor home for vacancy just as you would if you were leaving your house for an extended period:

CAUTION

Remove all food and items that may spoil and/or cause odors from refrigerator and cabinets before storage or anytime you would not be able to monitor refrigerator operation.

Clean and Prep Coach for Storage

1. Turn off the LP gas tank.
2. Turn the furnace thermostat switch on the bottom of the thermostat to OFF.
3. **Remove all foods and items that may cause odors from cabinets and refrigerator.**
4. Clean and defrost the refrigerator. Prop the door open slightly to allow any odors to dissipate. Place an open box of baking soda inside the refrigerator to help absorb odors.
5. **Fully charge the batteries. Batteries must have at least 80% charge to survive freezing temperatures and long period of non-use.** We recommend that you connect a battery charger or plug in the shoreline once a month during long-term storage periods to maintain battery charge and to avoid sulfating. If connecting a charger directly to batteries, turn the Aux. Battery switch off to avoid electrical arcing when attaching and detaching charger clamps.

NOTE: We do not recommend leaving the shoreline plugged in continuously during storage periods because the batteries can lose electrolytic fluids and become damaged from continuous charging without periodic use. We recommend

following regular battery inspection and maintenance, especially in cold weather. See "Battery Storage and Maintenance".

6. After charging batteries, turn the Aux Battery Switch off to disconnect the batteries and avoid parasitic* drain. The inverter/charger must be shut off at the control panel to avoid draining the house batteries when the Aux. Battery switch is turned off. The inverter/charger is directly powered and is not affected by the Aux Battery Switch.

** Parasitic battery drain is the gradual drain by items connected directly to battery power such as clocks, radio memory and the engine computer.*

7. Have the vehicle chassis completely serviced and lubricated. Be sure radiator antifreeze protection level is sufficient for the lowest anticipated temperatures.
8. Wash and wax the coach.
9. Inspect all seams and seals around doors, windows, vents, and any other joints. Replace or repair any that are damaged. Sealing materials and compounds can be purchased from your dealer. Badly damaged weather seals may need to be replaced by your dealer.
10. Close all windows and roof vents. Protect all appliance vent openings from contamination by animals or insects (e.g. bird nests, wasp nests, etc.)
11. Lubricate all door hinges and locks.
12. Clean the interior of the coach. Dirt and stains are more easily removed when fresh.

NOTE: When storing your vehicle through the winter, or in cold climates, extra preparations need to be made to protect plumbing, appliances and systems that can be damaged by freezing temperatures. See "Winterizing" in Plumbing Section.

REMOVAL FROM STORAGE

1. Completely air out the motor home.
2. Have the entire LP gas system checked for leaks.

3. Check window operation.
4. Check cabinet and door hinges. Lubricate with penetrating oil, if necessary.
5. Close all faucets and drain valves that are open.
6. Add a few gallons of water to the fresh water tank and turn on the water pump to check for leaks especially at fittings.
7. Open all faucets in turn to release trapped air and check be sure faucet washers have not hardened during storage.
8. Sanitize the water system as outlined under "Disinfecting the Fresh Water System" in the Plumbing Section.
9. After disinfecting and flushing the water lines thoroughly with fresh water, remove the water filter diverter plug and install a new water filter cartridge. Store the diverter for future use. The diverter plug is intended for winterization only.
10. Check the toilet for proper operation.
11. Add water to the holding tank using the toilet flush pedal and galley sink faucet. Check to be sure dump valves seal tightly.
12. Check around all appliances for obstructions and ensure that all vent openings are clear.
13. Start refrigerator and check for proper cooling.
14. Clean paneling and counter surfaces.
15. Replace batteries if necessary and check out electrical system to make sure all lights and electrical components operate.
16. Check tires for proper cold inflation pressure. See Vehicle Certification Label.
17. After washing accumulated winter grime from the vehicle, it is important to carefully inspect the seams and sealants for separation or cracks that may have appeared around the window frames, vents and any other joints. See "Sealants" at the beginning of this section.

Re-sealing is quite simple and the material is quickly and easily applied. Appropriate compounds are available from your dealer. See "Recommended Sealant Application" page at the end of this section.

Also inspect weather seals around doors, etc., and if necessary, have a dealer replace immediately.

CHASSIS SERVICE AND MAINTENANCE

Consult the appropriate sections in your chassis operating guide for specific information regarding operating safety, service recommendations and maintenance schedules for the chassis section of your motor home.

COACH MAINTENANCE CHART

These recommendations apply for normal recreational use. Heavy duty or full-time use may require more frequent maintenance intervals.

Always use specified sections or manufacturer's guide for further information and instructions.	Before Each Use	Weekly	Monthly	Every 3 Months	Every 6 Months	Every Year	As Necessary
LP System							
Have LP system checked for leaks.						◆	◆
Pressure regulator - inspect and adjust if needed						◆	
Check LP tank condition, mounting and fittings						◆	
Electrical System							
Check Battery Condition Meter	◆						
Check battery fluid level & connections			◆				
Check 12V fuses & 120V breakers							◆
Check GFCI Receptacles			◆				
Generator							
Visually inspect Generator and Compartment	◆						
See generator manufacturer's maintenance guide							◆
Plumbing System							
Sanitize plumbing system							◆
Winterize plumbing system							◆
Clean water pump strainer filter						◆	◆
Slide-Out & Leveling System							
Check Hydraulic Oil Level			◆				◆
Check Hydraulic Lines (routing, leaks, etc.)						◆	
Check & inspect room seals (bulb seals)					◆		◆
Exterior							
Clean roof				◆			◆
Clean sidewalls			◆				◆
Clean windows							◆
Flush underside of vehicle				◆			◆

COACH MAINTENANCE CHART

These recommendations apply for normal recreational use. Heavy duty or full-time use may require more frequent maintenance intervals.

Always use specified sections or manufacturer's guide for further information and instructions.	Before Each Use	Weekly	Monthly	Every 3 Months	Every 6 Months	Every Year	As Necessary
Safety Equipment							
Check operation of the following items							
Headlights, Taillights and Marker Lights	◆		◆				
Turn Signals	◆		◆				
Horn	◆		◆				
Hazard Warning Flashers	◆		◆				
Windshield Wipers & Washers	◆		◆				
Fire Extinguisher - check charge indicator	◆		◆				
Smoke Alarm - test operation *	◆		◆				
Carbon Monoxide Alarm - test operation *	◆		◆				
LP Gas Leak Detector - test operation	◆		◆				
(*replace battery if needed)							
Appliances							
Water Heater							
See water heater manufacturer's maintenance guide							◆
Inspect & clean exterior vent	◆						◆
Refrigerator							
See refrigerator maintenance guide							◆
Inspect and clean exterior vent & drip tray drain tube	◆						◆
Furnace							
See furnace manufacturer's maintenance guide							◆
Inspect & clean exterior vent	◆						◆
Air Conditioner							
See A/C manufacturer's maintenance guide							◆
Inspect for exterior damage				◆			◆
Check/Replace Filter			◆				
Range Top							
See range manufacturer's maintenance guide							◆
Inspect & clean/replace range hood grease filter							◆

COACH MAINTENANCE CHART

These recommendations apply for normal recreational use. Heavy duty or full-time use may require more frequent maintenance intervals.

Always use specified sections or manufacturer's guide for further information and instructions.	Before Each Use	Weekly	Monthly	Every 3 Months	Every 6 Months	Every Year	As Necessary
Sealants							
Inspect					◆		◆
Replace							◆
Frame & Chassis							
Follow Chassis manufacturer's maintenance guide (Refer to Chassis Operating Guide)							◆
Inspect Hitch Receiver (if towing)	◆						
Tires							
Check & adjust air pressure	◆						◆
Check tread wear	◆						◆
Check front end alignment and adjust if needed							◆
Miscellaneous							
Lubricate locks, hinges, latches						◆	◆

RECOMMENDED SEALANT APPLICATION

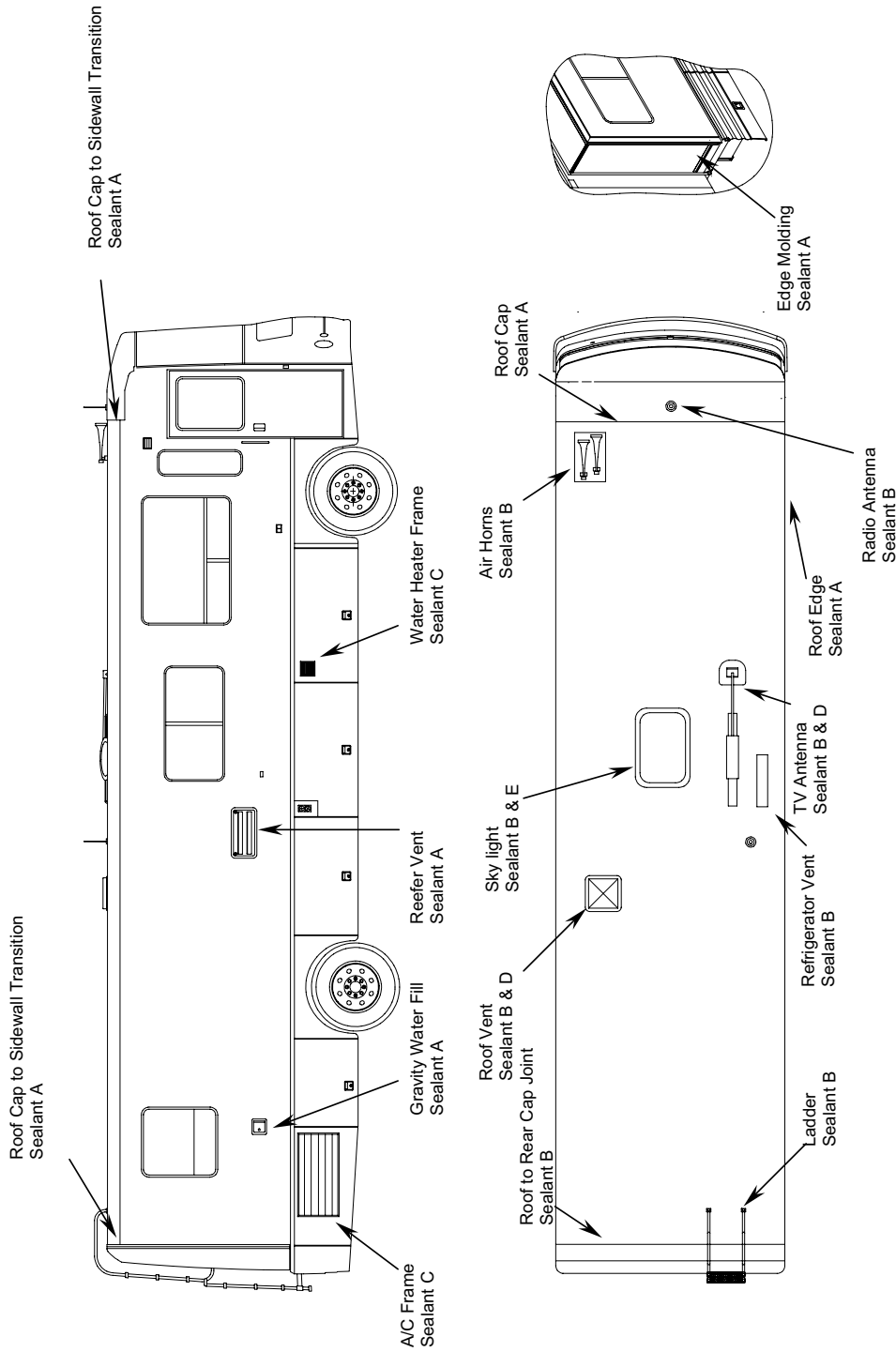

Sealants may be purchased from your Winnebago or Itasca Dealer

Sealant	Winnebago Part #
A	072889-10-000
B	131264-03-01A
C	094401-04-000
D	131264-01-02A
E	131264-04-01A

This is only a graphic representation for sealants and does not represent actual component position. Use sealant **094401-04-000** on components that fall into painted areas.

Revision A

Journey *SE*

Index

110-Volt AC System	6-1	Driving	2-1
110-Volt Circuit Breakers	6-4	DVD/VCR Combo Player and Home Theater	
110-Volt Receptacles (Outlets)	6-5	Surround Sound	8-1
12-Volt DC System	6-7	Effects of Prolonged Occupancy	2-6
12-Volt Fuses and Circuit Breakers	6-9	Electric Entrance Step	4-12
2006 New Vehicle Limited Warranty	1-7	Electrical Cautions	6-1
About this Manual	1-1	Electronic Compass and Outside	
Air Conditioner Filter	4-11	Thermometer	3-6
Air Hose Connector	3-22	Electronic Thermostat	4-8
Auto Air Conditioner/Heater	3-10	Emergency Exits	2-4
Automotive 12-Volt Fuses and Circuit		Emergency Information	1-6
Breakers	3-14	Engine Access Grille – Rear	3-12
Aux Fan Switch	3-10	Engine Block Heater	3-12
Aux Start Switch	3-9	Engine Cooling System	3-14
Auxiliary 110-Volt Generator	6-6	Engine Overheat	2-6
Auxiliary Battery (Aux Batt) Switch	6-7	Engine Top Access Covers – Rear	3-12
Bathroom	11-6	Exhaust Restriction Braking System	3-7
Battery Access	6-7	Exterior Finish	11-2
Battery Care	6-8	Exterior Shower	7-5
Battery Information	6-7	External Power Cord	6-1
Body and Chassis Specifications	1-4	Filling the Fuel Tank	3-11
Cabinetry	11-5	Fire Extinguisher	2-3
Car or Trailer Towing	3-18	Formaldehyde Information	2-1
Carbon Monoxide Alarm	2-2	Fresh Water System	7-1
Carbon Monoxide Warning	2-2	Front Axle Tire Alignment	1-2
Care and Maintenance of your Solid Surface		Front End Masks and Paint Damage	11-2
Countertop	11-5	Front TV Ignition Switch Interlock	8-1
Care of Decals	11-2	Fuel Selection	3-11
Central Air Conditioner	4-11	Fuel/Water Separator	3-13
Chassis Battery Cutoff Switch	3-14	Galley Sink	11-6
Chassis Owner's Manual	1-2	Gas/Electric Water Heater	4-6
Chassis Service and Maintenance	11-9	General Warnings	2-1
Checking Hydraulic Oil Level	10-7	Ground Fault Circuit Interrupter	6-5
Child Restraints	3-3	Hazard Warning Lights	3-8
Coach Maintenance Chart	11-10	Headlights and Exterior Lights	11-3
DC-AC Inverter - 600 Watt	8-2	Heat Pump	4-10
Dinette/Bed Conversion	9-2	Ice Maker	4-1
Disinfecting Fresh Water Systems		In-Dash Radio	3-10
on RV's	7-4	Interior Softgoods	11-4
Doors and Windows	11-6		

Inverter/Charger Unit - 2000W	6-4	Roadside Emergency	2-4
Jump Starting	2-5	Roof	11-1
Lights	3-16	Roof Loading	3-17
Loading the Vehicle	3-16	Safe Use of the LP Gas System	5-2
LP Gas Furnace	4-8	Safety Messages Used in this Manual	1-1
LP Gas Leak Detector	2-1	Sealants	11-1
LP Gas Supply	5-1	Seat Belts	3-2
LP Gas Warnings and Precautions	5-3	Seats	3-1
Map Light Switch	3-8	Service and Assistance	1-2
Microwave Oven	4-2	Shower Hose Vacuum Breaker	7-5
Motor Aid Water Heater	4-7	Signal Lever/Headlight Hi/Lo Beam	3-9
Mountain Driving	3-20	Sleeping Facilities	9-2
Nighter Blinds	11-7	Slideout Room Emergency Retraction Procedures	10-4
Nighter Pleated Blinds	9-5	Slideout Room Extension	10-1
OnePlace Systems Monitor Panel	4-3	Slideout Room Troubleshooting	10-3
Owner InfoCase	1-2	Smoke Alarm	2-3
Owner Information	1-6	Solar Charger Panel	4-5
Parking Brakes	3-7	Starting and Stopping Engine	3-11
Plastic Parts - Cleaning	11-3	Steering Column Tilt/Telescope	3-9
Portable Satellite Dish, Cable TV and Phone Hook-ups (Input)	8-3	Stepwell Cover	4-12
Power Center	6-3	Storage Compartment Doors	3-22
Power Door Locks	3-3	Suspension Alignment and Tire Balance	3-15
Power Electric Mirrors	3-4	Swivel Glider Lounge Chair	9-1
Power Roof Vent	4-13	Tank Capacities	1-5
Power Sunvisors	3-6	Thermostat Operation	4-10
Powerline Energy Management System	4-5	Tires	3-15
Pre-Delivery Inspection	1-2	Toilet	7-5
Preparing Vehicle for Storage	11-7	Tool and Ladder Storage	3-21
Pressure Regulator	5-4	Towing Guidelines	3-20
Pressure-Temperature Relief Valve	4-6	Trailer Wiring Connector	3-20
Range and Oven	4-2	TV Antenna	8-2
Range and Refrigerator	11-6	Underbody	11-1
Range Hood	4-3	Utility Light	7-8
Rearview Monitor System	3-6	Vehicle Certification Label	1-3
Recommended Sealant Application	11-13	Vehicle Information Center	3-6
Refrigerator	4-1	Video Control Center	8-1
Refrigerator Service Access Compartment	4-1	Vinyl Wallboard	11-5
Removal From Storage	11-8	Waste Water System (Holding Tanks)	7-5
Reporting Safety Defects	1-2	Water Drain Valves	7-8
Rest Easy Multi-Position Lounge	9-3	Water Heater By-pass Valve	4-8

Water Pump 7-2
Water Purifier System 7-3
Water System Drain Valve Locations 7-14
Weighing Your Loaded Vehicle 3-17
Windows 4-13
Windshield Washers and Wipers 3-15
Winterizing Procedure 7-9
Wood Furniture and Cabinetry 9-5
