

# **VISTA**

## **26HE/31KE**



# TABLE OF CONTENTS

---

## 1 – INTRODUCTION

About this Manual .....	1-1
Safety Messages Used in this Manual .....	1-1
Pre-Delivery Inspection .....	1-2
Front Axle Tire Alignment .....	1-2
Service and Assistance .....	1-2
Reporting Safety Defects .....	1-2
Occupant and Cargo Carrying Capacity Label .....	1-3
Vehicle Certification Label .....	1-4
Specifications and Capacities .....	1-5
Owner and Vehicle Information .....	1-6

## 2 – SAFETY AND PRECAUTIONS

General Warnings .....	2-1
Driving Safety .....	2-1
Fuel and Propane Gas .....	2-2
Propane Gas Leaks .....	2-3
Propane Gas Leak Detector .....	2-3
Carbon Monoxide Warning .....	2-4
Carbon Monoxide Alarm .....	2-4
Smoke Alarm .....	2-5
Fire Extinguisher .....	2-5
Electrical .....	2-6
Loading .....	2-6
Maintenance .....	2-6
Emergency Exits .....	2-6
Slideout Rooms .....	2-7
Roof .....	2-8
Formaldehyde Information .....	2-8
Mold, Moisture, and Your Motorhome .....	2-8
Roadside Emergency .....	2-9
Jump Starting .....	2-10
Engine Overheat .....	2-10

## 3 – DRIVING YOUR MOTORHOME

Seats – Driver/Co-Pilot .....	3-1
Seat Belts .....	3-2
Child Restraints .....	3-3
Keys .....	3-3
Rearview Monitor System .....	3-4
Mirrors – Power Electric .....	3-4
Brake-Shift Interlock .....	3-5

---

## Table Of Contents

---

Park Brake – Foot Pedal .....	3-5
Tow/Haul Transmission Mode .....	3-5
Map Light Switch .....	3-6
Hazard Warning Flashers .....	3-6
Battery Boost Switch .....	3-6
Air Conditioner/Heater – Automotive (Dash) .....	3-6
Radio Power Switch .....	3-7
Radio – In-Dash .....	3-7
Front Service Access .....	3-7
Engine Access – Interior .....	3-8
Engine Cooling System .....	3-9
Tires .....	3-9
Suspension Alignment and Tire Balance .....	3-9
Lights .....	3-10
Circuit Breakers and Fuses – Chassis/Dash Automotive 12-Volt .....	3-10
<b>4 – APPLIANCES AND SYSTEMS</b>	
Refrigerator .....	4-1
Refrigerator Service Access Compartment .....	4-2
Range and Oven .....	4-2
Microwave Oven .....	4-4
Range Hood .....	4-4
Systems Monitor Panel .....	4-4
Water Heater – Gas .....	4-5
Pressure-Temperature Relief Valve .....	4-6
Propane Gas Furnace .....	4-7
Ducted Roof Air Conditioning System .....	4-8
Air Conditioner Filter .....	4-8
<b>5 – PROPANE GAS</b>	
Propane Gas Supply .....	5-1
Safe Use of the Propane Gas System .....	5-2
Propane Gas Warnings and Precautions .....	5-3
Propane Gas Pressure Regulator .....	5-4
Propane Vaporization in Cold Weather .....	5-5
<b>6 – ELECTRICAL</b>	
Electrical Cautions .....	6-1
Electrical System – House 120-Volt AC .....	6-1
Power Cord – External .....	6-1
Power Center .....	6-3
Circuit Breakers – House 120-Volt AC .....	6-4
Electrical Outlets – House 120-Volt AC .....	6-4
Ground Fault Circuit Interrupter .....	6-4
Electrical Generator – 120-Volt .....	6-5
Electrical System – House 12-Volt DC .....	6-6

---

## Table Of Contents

---

House/Coach Battery Disconnect Switch .....	6-6
Battery Access .....	6-7
Battery Care .....	6-7
Circuit Breakers and Fuses – House 12-Volt DC .....	6-9
<b>7 – PLUMBING</b>	
Fresh Water System .....	7-1
Water Pump .....	7-2
Disinfecting Your Fresh Water System .....	7-4
Shower Hose Vacuum Breaker .....	7-5
Toilet .....	7-5
Drainage System (P-Traps) .....	7-6
Waste Water System .....	7-6
Waterline & Tank Drain Valves .....	7-7
Water Heater Bypass and Antifreeze Siphon Valves .....	7-8
Winterizing Procedure .....	7-8
Water System Drain Valve Locations .....	7-13
<b>8 – ENTERTAINMENT</b>	
Front TV Ignition Switch Interlock .....	8-1
TV Antenna - Digital .....	8-1
TV Signal Amplifier .....	8-2
Cable TV Connection .....	8-2
<b>9 – FURNITURE AND SOFTGOODS</b>	
Lounge Chair - Swivel .....	9-1
Sleeping Facilities .....	9-1
Dinette/Bed Conversion .....	9-1
U-Shaped Dinette/Bed Conversion .....	9-3
Sofa/Bed Conversion .....	9-3
Bunk – Front Pull Down .....	9-4
Roller Shades .....	9-5
Wood Furniture and Cabinetry .....	9-5
<b>10 – SLIDEOUT ROOMS AND LEVELING</b>	
Slideout Room Keylock .....	10-1
Slideout Room Operation – Electric .....	10-1
Slideout Room – Extreme Weather Precaution .....	10-2
Slideout Room Troubleshooting (Lippert) .....	10-3
Slideout Emergency Retraction (Lippert) .....	10-4
General Slideout Care .....	10-5
Leveling System .....	10-6
Checking Hydraulic Oil Level .....	10-7
<b>11 – MAINTENANCE AND STORAGE</b>	
Sealants – Inspection and General Information .....	11-1
Roof .....	11-1

---

## Table Of Contents

---

Undercarriage .....	11-1
Exterior Finish .....	11-2
Exterior Graphic Care .....	11-3
Plastic Parts – Cleaning .....	11-3
Exterior Lights .....	11-4
Interior Soft Goods .....	11-4
Ceiling Fabric Care .....	11-6
Cabinetry – Cleaning .....	11-7
Tables and Countertops .....	11-7
Galley Sink .....	11-7
Range and Refrigerator .....	11-7
Vinyl Flooring .....	11-7
Bathroom .....	11-8
Doors and Windows .....	11-9
Vehicle Storage – Preparation .....	11-9
Vehicle Storage – Removal .....	11-10
Chassis Service and Maintenance .....	11-10
Coach Maintenance Chart .....	11-11

## 12 – MISCELLANEOUS

Loading the Vehicle .....	12-1
Weighing Your Loaded Vehicle .....	12-1
Car or Trailer Towing .....	12-3
Trailer Wiring Connector .....	12-4
Towing Guidelines .....	12-4
Entry Step – Electric .....	12-5
Windows .....	12-6
Power Awning .....	12-7
Storage Compartment Doors .....	12-8
Effects of Prolonged Occupancy .....	12-8

---

# SECTION 1 - INTRODUCTION

---

Congratulations! We welcome you to the exciting world of motorhome travel and camping. You will find it convenient and enjoyable to have all the comforts of home and still enjoy the great outdoors wherever you choose to go.

Before sliding into the driver's seat, please become familiar with operations and features. In addition, spend some time with the dealer when you take delivery to learn all you can about your new motorhome.

---

---

## ABOUT THIS MANUAL

This operator's manual was prepared to aid you in the proper care and operation of the vehicle and equipment.

Please read this manual completely to understand how everything in your coach works before taking it on its "maiden voyage". In addition, please become familiar with the New Vehicle Limited Warranty.

*NOTE: This manual describes many features of your motorhome and includes instructions for its safe use.*

*This manual, including photographs and illustrations, is of a general nature only.*

***Some equipment and features described or shown in this manual may be optional or unavailable on your model.***

*Because of Winnebago Industries<sup>®</sup>, continuous program of product improvement, it is possible that recent product changes and information may not be included.*

*The instructions included in this manual are intended as a guide, and in no way extend the responsibilities of Winnebago Industries beyond the standard written warranty as presented in this manual.*

*The descriptions, illustrations, and specifications in this manual were correct at the time of printing. We reserve the right to change specifications or*

*design without notice, and without incurring obligation to install the same on products previously manufactured.*

The materials in your InfoCase contain warranty information and operating and maintenance instructions for the various appliances and components in your motorhome.

*NOTE: Many of the instruction sheets and manuals for the various appliances and components have been incorporated into the Operator's Manual Supplement for your convenience.*

*Please read the FAQ in Section 1 of the Operator's Manual Supplement for more details.*

Throughout this manual, frequent reference is made to the vehicle chassis manual that is provided by the manufacturer of the chassis on which this motorhome is built.

Consult the chassis manual for operating, safety, and maintenance instructions pertaining to the chassis section of the motorhome.

---

---

## SAFETY MESSAGES USED IN THIS MANUAL

Throughout this manual, certain items are labeled Danger, Warning, Caution, Notice, or Note. These terms alert you to precautions that may involve damage to your vehicle or a risk to your personal safety. Read and follow them carefully.



DANGER indicates a hazardous situation which, if not avoided, will result in death or serious personal injury.

## SECTION 1 - INTRODUCTION

---



### WARNING

WARNING indicates a hazardous situation which, if not avoided, could result in death or serious personal injury.



### CAUTION

CAUTION indicates a hazardous situation which, if not avoided, could result in minor or moderate personal injury.

### NOTICE

NOTICE is used to address practices not related to personal injury.

*NOTE: A “Note” is not necessarily safety-related, but indicates a recommendation or special point of information that could assist in understanding the use or care of a feature item.*

---

## PRE-DELIVERY INSPECTION

This motorhome has been thoroughly inspected before shipment. Your dealer is responsible for performing a complete pre-delivery inspection of the chassis and all motorhome components.

As a part of the pre-delivery inspection procedure, the dealer is responsible for road testing the motorhome, noting, and correcting any problems before delivery.

---

## FRONT AXLE TIRE ALIGNMENT

We recommend that you have the front suspension and steering alignment checked and adjusted after you have fully loaded the vehicle according to your needs. Thereafter, have alignment inspected periodically to maintain vehicle steering performance and prevent uneven tire wear.

---

## SERVICE AND ASSISTANCE

Your dealer will be glad to provide any additional information you need, as well as answer any questions you might have about operating the equipment in your coach. When it comes to service, remember that your dealer knows your vehicle best and is interested in your satisfaction. Your dealer will provide quality maintenance and any other assistance that you may require during your ownership of this vehicle.

If you need warranty repairs while traveling, you may take your vehicle to any authorized Winnebago Industries® dealership and request their assistance.

See the Service Dealer Directory in your InfoCase.

---

## REPORTING SAFETY DEFECTS

If you believe that your vehicle has a defect which could cause a crash or could cause injury or death, you should immediately inform the National Highway Traffic Safety Administration (NHTSA) in addition to notifying Winnebago Industries, Inc.

If NHTSA receives similar complaints, it may open an investigation, and if it finds that a safety defect exists in a group of vehicles, it may order a recall and remedy campaign. However, NHTSA cannot become involved in individual problems between you, your dealer, or Winnebago Industries®.

To contact NHTSA, you may either call the Vehicle Safety Hotline toll-free at:  
1-888-327-4236; (TTY: 1-800-424-9153)



or go to their website at <http://www.safercar.gov>  
or write to:

Administrator, NHTSA  
1200 New Jersey Avenue S.E.  
Washington, D.C. 20590

You can also obtain other information about  
motor vehicle safety from the NHTSA website  
at <http://www.safercar.gov>

---

---

## OCCUPANT AND CARGO CARRYING CAPACITY LABEL

This label is affixed in the driver's area next to  
or near the Vehicle Certification Label. It  
contains vehicle occupant and cargo carrying  
capacity along with the number of seat belt  
positions in the vehicle. The label also provides  
the weight of a full load of water and advises that  
this weight, along with the tongue weight counts  
as cargo.

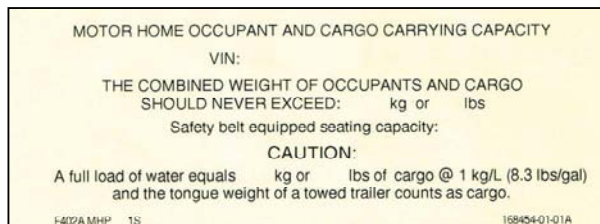

If any weight exceeding 45.4 kg (100 lbs.) is  
added to your coach between final vehicle  
certification and first retail sale, the occupant and  
cargo carrying capacity must be corrected and a  
label similar to the one shown below will be  
affixed inside your coach.



# SECTION 1 - INTRODUCTION

## VEHICLE CERTIFICATION LABEL

This label is affixed to the lower driver side armrest panel, driver door, or the driver side door jamb, depending on model. It contains vehicle identification numbers and other important reference information.

MANUFACTURED BY WINNEBAGO IND. INC.			INCOMPLETE VEHICLE MANUFACTURED BY			
3			1		2	
			GVWR		LB	
			4		KG	
GAWR:			SUITABLE TIRE AND RIM CHOICE		COLD INFLATION PRESSURE	
FRT 5 LB KG			TIRE 6		RIM 7	
RR LB KG					8 PSI KPA 9	
					PSI KPA	
THIS VEHICLE HAS BEEN COMPLETED IN ACCORDANCE WITH THE PRIOR MANUFACTURER'S IVD, WHERE APPLICABLE. THIS VEHICLE CONFORMS TO ALL APPLICABLE FEDERAL MOTOR VEHICLE SAFETY STANDARDS IN EFFECT ON THE DATE OF MANUFACTURE SHOWN ABOVE.						
SERIAL NO. 10		VIN 11		TYPE 12		COLOR 13
XXXXX XXXX XX XX/XX/XX XXX-XXXXX		14		15		XXXXXX-XXX

### EXPLANATION OF DATA

1. Chassis manufacturer.
2. Chassis manufacture date.
3. Month and year of manufacture at Winnebago Industries®.
4. Gross Vehicle Weight Rating: Total permissible weight of the vehicle, including driver, passengers, total cargo carried (including all liquids), and equipped with all options.
5. Gross Axle Weight Rating: Total permissible weight allowed for the front and rear axles (listed in pounds and kilograms).
6. Suitable Tire Choice: Tires recommended to meet handling and safety requirements. When replacing any of the tires on your vehicle, always replace with a tire that meets these specifications.
7. Suitable Rim Choice: Wheel rims recommended to meet handling and safety requirements. When replacing any of the rims on your vehicle, always replace with a rim that meets these specifications.
8. Cold Inflation Pressure: Inflation pressures at Gross Axle Weight Ratings recommended (while cold) for the tires originally equipped on your vehicle. These pressure levels must be maintained to assure proper handling, safety, and fuel economy.
9. Rear Axle Wheel Configuration: Single or Dual as it relates to the inflation.
10. Serial Number: This is the serial number assigned to the completed vehicle by Winnebago Industries.
11. Vehicle Identification Number (VIN): This number identifies the chassis on which the motorhome is built. The 10th digit of the VIN designates the chassis model year. (C=2012, D=2013, E=2014, etc.). This information is useful when ordering chassis repair parts.
12. Type: States the NHTSA designated usage classification for your motorhome. MPV signifies a Multi-purpose Passenger Vehicle.
13. Color: Signifies the color code number of the decor used throughout the vehicle. This number is necessary for ordering replacement cushions, curtains, carpet, etc.
14. Winnebago® model year and series/family name.
15. Model: Lists the Winnebago product model number of your vehicle.

---



---

**SPECIFICATIONS AND CAPACITIES**

---

	<b>26HE</b>	<b>31KE</b>
	<b>Ford® F53 16,000 lb. Chassis with 19.5" Tires</b>	<b>Ford® F53 18,000 lb. Chassis with 19.5" Tires</b>
Feature Number	16N	16N
Length	26' 11.1"	31' 1.7"
Exterior Height <sup>1</sup>	12' 2"	12' 3"
Exterior Width <sup>2</sup>	8' 5.5"	8' 5.5"
Exterior Storage <sup>3</sup>	117 cu. ft.	168 cu. ft.
Awning Length	19'	17'
Interior Height	6' 8"	6' 8"
Interior Width	8' 0.5"	8' 0.5"
Freshwater Tank Capacity <sup>4</sup>	54 gal.	64 gal.
Water Heater Capacity	6 gal.	6 gal.
Holding Tank Capacity - Black <sup>4</sup>	43 gal.	41 gal.
Holding Tank Capacity - Gray <sup>4</sup>	38 gal.	57 gal.
Propane Capacity <sup>5</sup>	18 gal.	18 gal.
Wheelbase	158"	190"
GVWR	16,000 lbs.	16,000 lbs.
GAWR - Front	6,500 lbs.	6,500 lbs.
GAWR - Rear	11,000 lbs.	11,000 lbs.
GCWR <sup>6</sup>	23,000 lbs.	23,000 lbs.
Fuel Capacity	80 gal.	80 gal.

**Notes:**

All information is based upon the most recent data available. Visit the Winnebago Industries, Inc. web page – [www.winnebagoind.com](http://www.winnebagoind.com) – for the most current product information.

<sup>1</sup> The height of each model is measured to the top of the tallest standard feature and is based on the curb weight of a typically equipped unit. The actual height of your vehicle may vary by several inches depending on chassis or equipment variations. Contact your dealer for further information.

<sup>2</sup> Floorplans feature a wide-body design - over 96". You should be aware that some states restrict access on some or all state roads to 96" in body width. You should confirm the road usage laws in the states of interest to you.

<sup>3</sup> The load capacity of your motor home is designated by weight, not by volume, so you cannot necessarily use all available space when loading your motor home.

<sup>4</sup> Capacities are based on measurements prior to tank installation. Slight capacity variations can result upon installation.

<sup>5</sup> Capacities shown are the tank manufacturer's listed water capacity (W.C.). Actual filled propane capacity is 80% of listing due to overfilling prevention device on tank.

<sup>6</sup> Actual towing capacity is dependent on your particular loading and towing circumstances which includes the GVWR, GAWR, and GCWR as well as adequate trailer brakes. Refer to the chassis operator's manual of your motor home for further towing information.

**SECTION 1 -  
INTRODUCTION**

---

---

**OWNER AND VEHICLE INFORMATION**

**OWNER INFO**

Owner's Name(s) \_\_\_\_\_

Address \_\_\_\_\_

\_\_\_\_\_

**VEHICLE INFORMATION**

Motorhome Model Number \_\_\_\_\_

Motorhome Serial Number \_\_\_\_\_

Chassis Vehicle Identification No. (VIN) \_\_\_\_\_

Vehicle Mileage at Delivery \_\_\_\_\_

Selling Dealer Name \_\_\_\_\_

Address \_\_\_\_\_

\_\_\_\_\_

**YOUR WINNEBAGO INDUSTRIES® DEALER /SERVICE CENTER**

Name \_\_\_\_\_

Address \_\_\_\_\_

\_\_\_\_\_

Contact \_\_\_\_\_ Phone \_\_\_\_\_

**CHASSIS SERVICE CENTER**

Name \_\_\_\_\_

Address \_\_\_\_\_

\_\_\_\_\_

Contact \_\_\_\_\_ Phone \_\_\_\_\_

**RV INSURANCE POLICY**

Company \_\_\_\_\_

Policy Number \_\_\_\_\_

Agent \_\_\_\_\_ Phone \_\_\_\_\_

## SECTION 2 - SAFETY AND PRECAUTIONS



### GENERAL WARNINGS

- Only seats equipped with seat belts are to be occupied while the vehicle is moving.
- Make sure all passengers have seat belts fastened. Lap belts should fit low on the hips and upper thighs. The shoulder belt should be positioned snug over the shoulder.
- For pregnant women: Never place the shoulder belt behind your back or under your arm. Adjust the lap belt across your hips/pelvis, and below your belly. Place the shoulder belt across your chest (between your breasts) and away from your neck.
- Child restraints should be installed properly according to manufacturer's instructions. See "Child Restraints".
- All moveable or swiveling seats should be placed and locked in travel position while the vehicle is moving.
- Never let passengers stand or kneel on seats while the vehicle is moving.
- Sleeping facilities are not to be utilized while vehicle is moving.
- Examine the escape window and be familiar with its operation.
- Inspect the fire extinguisher monthly for proper charge and operating condition. This should also be done before beginning a vacation or any extended trip.

### DRIVING SAFETY

#### WARNING

This motorhome has been designed, manufactured and tested with concern for the protection of its occupants. We recommend you perform the following inspections for your safety and the safety of your passengers before starting your vehicle.

1. LP GAS SYSTEM - Turn off at tank for traveling. Test for leaks upon arrival at destination before lighting pilots.
  2. WHEELS - Inspect for damage and check lug nuts for tightness.
  3. TIRES - Inspect for wear and damage and check for recommended air pressure.
  4. LIGHTING - Test for proper operation of all interior and exterior lights including dash lights, headlights, tail lights, brake lights, clearance lights, and turn signals.
  5. EXITS - Inspect release mechanism on emergency exit window, test both locks on main entrance door for ease of operation and instruct passengers how to use both means of exit.
  6. SEAT BELTS - Direct passengers to designated seats, be certain swivel seats are locked into position, and require use of a seat belt. See operator's manual for occupancy and weight restrictions.
  7. APPLIANCES - Turn off and latch or lock doors where provided.
  8. LOOSE PARCELS - Store securely.
  9. UTILITY SUPPLY LINES - Disconnect all electrical, sewer and water lines and secure properly.
  10. ENTRANCE DOOR STEP - Assure step is in retracted position for traveling.
- Read your motorhome and chassis owner's manual for further precautions.

- Do not attempt to adjust the driver's seat while the vehicle is moving.
- Do not adjust tilt steering in a moving vehicle.



## SECTION 2 - SAFETY AND PRECAUTIONS

- Do not operate the cruise control on icy or extremely wet roads, winding roads, in heavy traffic, or in any other traffic situation where a constant speed cannot be maintained.
- Use care when accelerating or decelerating on a slippery surface. Abrupt speed changes can cause skidding and loss of control.
- Never drive the vehicle with a slideout room extended.
- Driving through water deep enough to wet the brakes may affect stopping distance or cause the vehicle to pull to one side. Check brake operation in a safe area to be sure they have not been affected. Never operate any vehicle if a difference in braking efficiency is noticeable.
- Adverse weather conditions and extremes in terrain may affect handling and/or performance of your vehicle. Refer to your chassis manual for complete and related information on driving your vehicle.

---

---

### FUEL AND PROPANE GAS



#### DANGER

All pilot lights, appliances, and their ignitors (see operating instructions) shall be turned off before refueling of motor fuel tanks and/or propane containers. Failure to comply could result in death or serious injury.



#### WARNING

Propane gas containers, gasoline, or other flammable liquids shall not be placed or stored onboard the vehicle because a fire or explosion may result. Propane gas containers are equipped with safety valves, which relieve excessive pressure by discharging gas to the atmosphere. Failure to comply could result in death or serious injury.

- All pilot lights must be extinguished and appliances turned off while refilling the fuel tank or propane gas tank.
- Never smoke while refilling vehicle fuel tank or propane gas tank.
- Never use an open flame to test for propane gas leaks. Replace all protective covers and caps on propane system after filling. Make sure valve is closed and the door is latched securely.
- Never connect natural gas to the propane gas system.
- When lighting range burners, **do not** turn burner controls to “On” and allow gas to escape before lighting match.
- Portable fuel-burning equipment, including wood and charcoal grills and stoves shall not be used inside the recreational vehicle. The use of this equipment inside the recreational vehicle may cause fires or asphyxiation.
- Propane gas regulators must always be installed with the diaphragm vent facing downward. Regulators are equipped with a protective cover. Make sure that the regulator vent faces downward and that the cover is kept in place to minimize vent blockage, which could result in excessive gas pressure causing fire or explosion.
- The following warning label is located in the cooking area to remind you to provide an adequate supply of fresh air for combustion.



**⚠ DANGER**

Do not use gas cooking appliances for comfort heating. May lead to carbon monoxide poisoning, which can lead to death or serious injury.

**⚠ WARNING**

Gas cooking appliances need fresh air for safe operation. Before operating: Open vents or windows slightly or turn on exhaust fan prior to using cooking appliance. Gas flames consume oxygen, which should be replaced to ensure proper combustion. Improper use may result in death or serious injury.

Unlike homes, the amount of oxygen supply is limited due to the size of the recreational vehicle, and proper ventilation when using the cooking appliance(s) avoids dangers of asphyxiation. It is especially important that cooking appliances not be used for comfort heating, as the danger of asphyxiation is greater when the appliance is used for long periods of time. Failure to comply could result in death or serious injury.

---

---

## PROPANE GAS LEAKS

Check propane gas system for leaks yearly, or as necessary.

The following procedures are noted on a label, located in the vehicle near the range area. If you smell gas within the vehicle, quickly and carefully perform the procedures listed.

### IF YOU SMELL PROPANE

- Extinguish any open flames, pilot lights, and all smoking materials.
- Do not touch electrical switches.
- Shut off the gas supply at the tank valve(s) or gas supply connection.

- Open doors and other ventilating openings.
- Leave the area until odor clears.
- Have the propane system checked and leakage source corrected before using again.

Failure to comply could result in death or serious injury.

---

---

## PROPANE GAS LEAK DETECTOR

Your coach is equipped with a Propane Gas Leak Detector, similar to the one shown below. The leak detector sounds an alarm if an unsafe amount of propane gas is present inside the coach.



Propane Gas Leak Detector

**⚠ WARNING**

**EXPLOSION HAZARD: DO NOT** use an open flame to test for gas leaks. When testing for gas line leaks with a soapy water solution, **DO NOT** use a detergent containing ammonia or chlorine. These substances may generate a chemical reaction causing corrosion to gas lines, resulting in dangerous leak conditions. Death or serious injury can result.

### Power Connection

The Propane Gas Leak Detector is powered by the house batteries. If the House/Coach Battery Disconnect switch is shut off or the battery cable is disconnected from the batteries, the alarm will





## SECTION 2 - SAFETY AND PRECAUTIONS

not work. The Propane Gas Leak Detector fuse or circuit breaker is located in the 12-volt house electrical load center.

Because the Propane Gas Leak Detector is connected to the house battery, it is always drawing a small amount of current. Even though this current draw is slight, it could drain the house battery during storage periods when the house battery will not be charged regularly by the engine or shoreline.

### Replacement

When replacing this alarm, we recommend replacing only with the same model, or with one that is also listed for RV application. We recommend obtaining a replacement from your Winnebago Industries® dealer.

### Further Information

See the manufacturer's user guide provided in your InfoCase for further instructions.

To allow proper operation of the vehicle's ventilation system, keep front ventilation inlet grill clear of snow, leaves, or other obstructions at all times. **DO NOT OCCUPY A PARKED VEHICLE WITH ENGINE RUNNING FOR AN EXTENDED PERIOD.**

Do not run engine in confined areas, such as a garage, except to move vehicle into or out of the area.

## CARBON MONOXIDE ALARM

Your coach is equipped with a Carbon Monoxide (CO) Alarm, which has a sensor that is designed to detect toxic carbon monoxide gas fumes resulting from incomplete combustion of fuel. It will detect CO gas from any combustion source such as the furnace, gas range/oven, water heater, refrigerator, chassis engine, and electric generator engine.

## CARBON MONOXIDE WARNING

 <b>WARNING</b>
Avoid inhaling exhaust gases, as they contain carbon monoxide, which is a colorless, odorless, and poisonous gas. Death or serious injury can result.

The best protection against carbon monoxide entry into the vehicle body is a properly maintained engine exhaust and ventilation system. It is recommended that the exhaust system and body be inspected by a qualified motorhome service center:

- Each time the vehicle is serviced for an oil change.
- Whenever a change in the sound of the exhaust system is noticed.
- Whenever the exhaust system, underbody, or rear of the vehicle is damaged.



Carbon Monoxide Alarm

 <b>WARNING</b>
Failure to replace this product by the "REPLACE BY DATE" printed on the alarm cover may result in death by Carbon Monoxide poisoning.





**Replacement**

When replacing this alarm, we recommend replacing only with the same model, or with one that is also listed for RV application. We recommend obtaining a replacement from your Winnebago Industries® dealer.

**Further Information**

Please read the information provided by the manufacturer, which is included in your InfoCase for further information.

---

---

**SMOKE ALARM**

Your coach is equipped with a Smoke Alarm (located on the ceiling in the lounge area.) The Smoke Alarm is powered by a 9-volt battery and has a sensor that is designed to detect smoke.



Smoke Alarm

The following label is affixed to the Smoke Alarm.

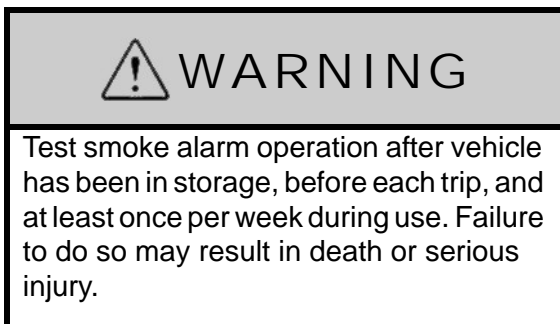

**Replacement**

When replacing this alarm, we recommend replacing only with the same model, or with one that is also listed for RV application. We recommend obtaining a replacement from your Winnebago Industries® dealer.

**Further Information**

See the manufacturer’s information in your InfoCase for further instructions.

---

---

**FIRE EXTINGUISHER**

A dry chemical Fire Extinguisher is located near the main entrance door.



Fire Extinguisher (Typical installation - your coach may vary according to model and floorplan)

We recommend that you become thoroughly familiar with the operating instructions displayed on the side of the Fire Extinguisher and in the information supplied in your InfoCase.

We also recommend that you inspect the Fire Extinguisher for proper charge at least once a month in accordance with National Fire Protection Association (NFPA) recommendations as stated on the label.

If the charge is insufficient, the Fire Extinguisher must be replaced.

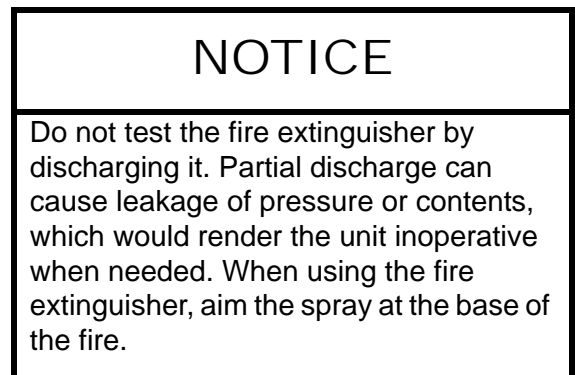



## SECTION 2 - SAFETY AND PRECAUTIONS

---

### Replacement

If for any reason you must replace the Fire Extinguisher, the replacement must be the same type and size as the one originally supplied in your coach. We recommend obtaining a replacement only from your Winnebago Industries® dealer or a reliable RV parts supplier.

---

### ELECTRICAL

- Careless handling of electrical components can be fatal. Never touch or use electrical components or appliances while feet are bare, while hands are wet, or while standing in water or on wet ground.
- Improper grounding of the vehicle can cause personal injury. Do not plug the utility power cord into an outlet which is not grounded and do not adapt the plug to connect to a receptacle for which it is not designed.
- Do not attach an extension cord to the utility power cord.
- Do not use any electrical device that has had the ground pin removed.
- Avoid overloading electrical circuits. Replace fuses or circuit breakers with those of the same size and amperage rating only. Never use a higher rated fuse or breaker.
- Use caution when handling or working near electrical storage batteries. Always remove jewelry and wear protective clothing and eye covering. Avoid creating sparks.

---

### LOADING

- Store or secure all loose items inside the motorhome before traveling. Possible overlooked items such as canned goods or small appliances on the countertop, cooking pans on the range, or free-standing furniture items can become dangerous projectiles during a sudden stop.
- Be aware of GVWR, GAWR, and individual load limit on each tire or set of duals (See “Loading the Vehicle” in *Section 12 - Miscellaneous*).

- Never load the motorhome in excess of the gross vehicle weight rating or the gross axle weight rating for either axle.

---

### MAINTENANCE

- Do not remove the radiator cap while engine and radiator are still hot. Always check coolant level visually at the see-through coolant reservoir.
- Never get beneath a vehicle that is held up by a jack only.
- Do not mix different construction types of tires on the vehicle, such as radial, bias, or belted tires, as vehicle handling may be affected. Replace tires with exact size, type, and load range.

---

### EMERGENCY EXITS

#### Escape Window

The bedroom escape window is secured by two red safety latches at the bottom or side of the window.

To open, lift both latches up and toward the center of the window, then push outward near the bottom of the window.



Escape Window  
(Lift both red safety latch handles UP and  
push window OUT)  
-Typical View



Escape Window  
(Lift both red safety latch handles UP and  
push window OUT)  
-Typical View

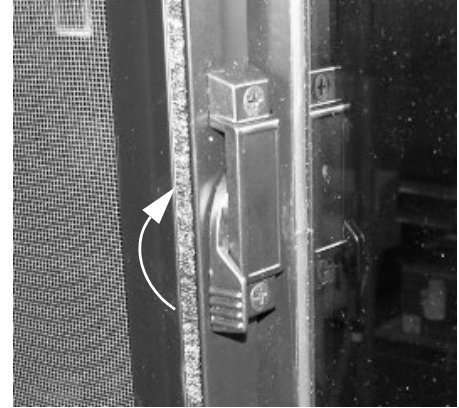

Slider Window Latch  
(Lift latch UP and slide window open)  
-Typical View



Escape Window  
(Lift both red safety latch handles UP and  
push window OUT)  
-Typical View

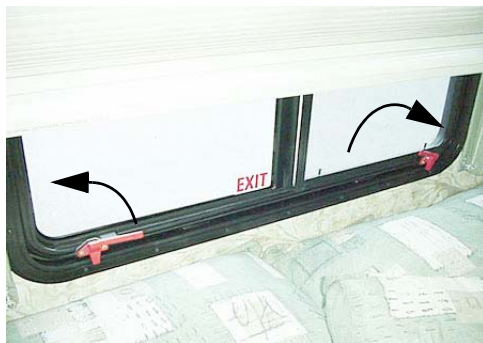

Escape Window  
(Lift both red safety latch handles UP and  
push window OUT)  
-Typical View

### Using Slider Windows As Emergency Exits

Some coaches are required to have a slider window as an alternate exit. This window will be marked EXIT and have a red-handled latch.

Most slider windows along the side of any motorhome can also be used as alternate emergency exits, should the need arise.

To use slider windows as an exit:

- Lift window latch UP.
- Slide the window open.
- Either slide the screen open or push the screen material out, depending on window construction.

---

---

### SLIDEOUT ROOMS

#### WARNING

Your motorhome may have more than one slideout room. Understand which switch operates which slideout room prior to operation. Make sure all slideout rooms are clear of people who could be harmed or obstacles that could cause damage prior to operating any slideout rooms. Failure to observe can result in death or serious injury.

Check inside and outside the vehicle to make sure that there are no people who could be harmed or obstacles that could cause damage due to room activation.



## SECTION 2 - SAFETY AND PRECAUTIONS

---



### WARNING

Keep all persons clear of the slideout room and moving parts while extending or retracting. Do not occupy the slideout room while it is being extended or retracted. Failure to observe can result in death or serious injury.

---

## ROOF



### WARNING

**STAY OFF ROOF.** Surface may be slippery. Falling could result in death or serious injury.

Walking or working on the roof should be left to qualified service personnel using proper safety equipment in a safe environment. You should only walk or work on the roof if you are qualified and have created a safe environment.

For your safety, it is not recommended that you store or carry items on the roof.

---

## FORMALDEHYDE INFORMATION

Some of the materials used in this recreational vehicle emit formaldehyde. Eye, nose, and throat irritation, headache, nausea, and a variety of asthma-like symptoms, including shortness of breath have been reported as a result of formaldehyde exposure. Reaction to formaldehyde exposure may vary among individuals. Elderly persons and young children, as well as anyone with a history of asthma, allergies, or lung problems may be at greater risk. Research is continuing on the possible long-term effects of exposure to formaldehyde. Inadequate ventilation may allow formaldehyde and other contaminants to accumulate in indoor air. Ventilation to dilute the indoor air may be

obtained from a passive or mechanical ventilation system. Always be sure to thoroughly ventilate your recreational vehicle before and during each use. High indoor temperatures and humidity may raise formaldehyde levels. When a recreational vehicle is in areas subject to high temperatures, an air conditioning system can be used to control indoor temperature levels. If you have any questions regarding the health effects of formaldehyde, consult your doctor or local health department.

---

## MOLD, MOISTURE, AND YOUR MOTORHOME

### What is Mold?

Molds are part of the natural environment. They are as old as the Earth itself and mold spores are almost everywhere at some level waiting to grow. Mold plays a part of nature by breaking down dead organic matter, such as fallen leaves and dead trees. Indoors however, mold growth should be avoided. Molds reproduce by means of tiny spores. Those spores are invisible to the naked eye and float throughout the outdoor and indoor air. Because of the nature of the use of a motorhome, it is natural for a motorhome to be introduced into an environment with mold spores.

Mold is a plant and requires its own special environment to grow. That environment includes organic materials, nutrients, moisture, and proper temperature.

### How Can I Avoid Mold?

To reduce the ability for mold to grow, you must reduce what constitutes its growth environment. Mold can grow with the smallest of a nutrient base. Just small amounts of dirt or dust on the carpet can be enough to allow the mold process to begin. Keep the environment as clean as possible. Vacuum the carpet. Clean food spills thoroughly and quickly. Avoid grease buildup near the stove or sink. Clean the exhaust fan above the stove often.



Minimize moisture in your motorhome and keep humidity low. Clean spills quickly. Do not allow condensation to build up. You can open windows and vents to minimize condensation. Use of the air conditioner can assist in removing moisture from the air. Avoid leaks, but if leaks do occur, make repairs promptly.

Avoid bringing mold into your motorhome. Plants, cloths, books, and other household items may already have mold present. It is easy to transfer mold into your motorhome environment.

Monitor your motorhome. Periodically check those hidden areas in corners, closets, and cabinets to assure mold is not present.

### **What if I Find Mold?**

If mold develops, clean the area with a concentrate of soap and bleach. Items that contain mold that cannot be cleaned should be removed from the vehicle.

### **Can Mold Harm Me?**

The effects of mold and airborne mold spores may cause irritation to some people. Experts disagree on the level of exposure that may cause health concerns.

### **If Mold Is Present, What Will Winnebago Industries® Do?**

If Winnebago Industries determines that mold is present in the Winnebago®/Itasca® motorhome as a result of a manufacturing defect reported to Winnebago Industries within the limited warranty period, Winnebago will clean the affected area(s) and/or replace affected items as it deems necessary. This is the extent of coverage provided by Winnebago Industries. Winnebago Industries, however, will not assume responsibility for mold deemed to be a result of a motorhome users lack of timely and appropriate action to mitigate circumstances should a problem occur.

If Winnebago Industries determines that mold is present due to conditions it determines is not a result of a manufacturing defect found within the warranty period, Winnebago Industries will not provide any financial assistance to the repair of the condition.

---

---

## **ROADSIDE EMERGENCY**

Because of the size and weight of this vehicle and its tires, and the possible complications involved in tire changing, we strongly advise obtaining professional road service to change a flat tire whenever possible. However, if an emergency requires you to change the tire yourself, please exercise extreme caution and read all tire changing information in the chassis manual.

Never get beneath a vehicle that is held up by a jack only.

### **If You Get A Flat Tire**

- DO NOT panic.
- Grip the steering wheel firmly and steer the vehicle as straight as possible. Avoid quick maneuvers. You may need to counter-steer to compensate for “pull” created by the failed tire.
- DO NOT stomp on the brake. This abruptly shifts the vehicle’s weight forward, making it nose-dive and pull toward the blown-out side.
- DO NOT jerk your foot off the accelerator. Just ease back on the accelerator slowly and gently to continue momentum. The deflated tire will slow the vehicle.
- If you must change lanes to get to a safe stopping place, use your signals to warn other motorists and change lanes smoothly and carefully after you are certain the lane is clear.
- Let the vehicle coast to a stop, gently steering to a safe stopping place off the traffic lanes of the road. Do not worry about damaging the tire or wheel rim by driving on it. A tire or wheel replacement is cheaper than damaging the vehicle or injuring yourself.
- When you have come to a stop, activate your hazard flashers to warn other motorists, then exit the vehicle carefully.
- Set out flares or other warning devices.

Check your tires for proper inflation before each trip and at least once a month with an accurate tire gauge.



## SECTION 2 - SAFETY AND PRECAUTIONS

---

### Recovery Towing

When calling a professional towing service, we recommend that you advise them of your coach length and approximate front axle weight listed on your Vehicle Certification Label. This will allow the towing operator to determine the proper towing equipment to use.

Winnebago Industries® does not assume responsibility for damage incurred while towing this vehicle.

*NOTE: Consult your chassis manual for towing instructions or precautions provided by the chassis manufacturer.*

#### NOTICE

Do not lift on bumper. Damage will result to front end body parts.



#### WARNING

Stay out from beneath the motorhome while it is suspended by the towing assembly. Do not allow passengers to occupy a towed vehicle. Death or serious injury can result.

#### NOTICE

Do not attempt to push start this vehicle. Damage to the transmission or other parts of the vehicle will occur.

---

### ENGINE OVERHEAT

If you see or hear steam escaping from the engine compartment or have any other reason to suspect an extreme engine overheating condition, pull the vehicle over to the roadside as soon as it is safe to do so, stop the engine, and get all passengers out of the vehicle.

#### NOTICE

Operating a vehicle under a severe overheating condition can result in damage to the vehicle.

For information on what to do in case of overheating, consult your chassis manual.

---

### JUMP STARTING

If your coach will not start from the chassis battery, try using the Battery Boost switch to divert power from the house batteries to the starter. (See “Battery Boost Switch” in *Section 3 - Driving Your Motor Home*).

If you wish to try jump starting the engine using another vehicle or booster system, see your chassis manual for connecting jumper cables to the automotive electrical system.

## SECTION 3 - DRIVING YOUR MOTORHOME

The information in this section refers only to features installed or adapted to the dash and driver compartment area by Winnebago Industries®. It also includes passenger seating in the living area of the coach.

### Further Information

See the chassis manual in your InfoCase for all original chassis related controls, instrumentation, switches, and other features. This includes items such as transmission, parking brakes, cruise control, gauges, wipers, lights, etc.

---

---

### SEATS – DRIVER/CO-PILOT

The driver and co-pilot seats may be independently adjusted to suit individual preference.

The seats may be swiveled to provide easy entrance and exit. The swivel feature also allows the seats on most models to be turned toward the living area for additional seating while the unit is parked.

#### WARNING

Assure seat is in its forward and locked position for travel. Do not adjust seat while vehicle is in motion. Failure to comply may result in injuries.

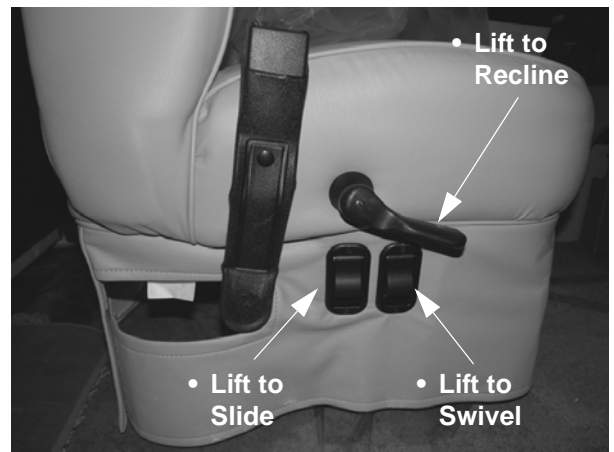

Driver Seat  
-Typical View

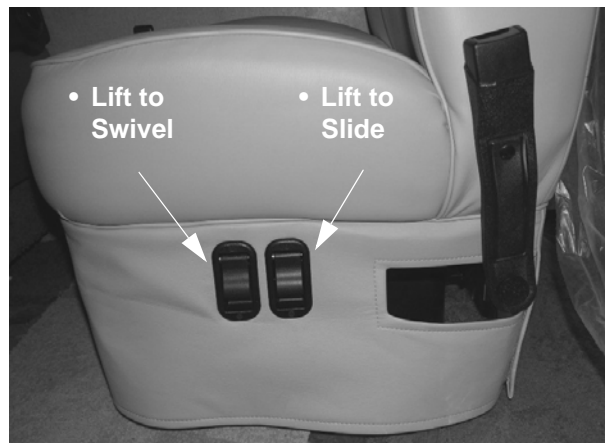

Passenger Seat  
-Typical View

### To Face Driver Seat Rearward

- Tilt the steering wheel all the way up.
- Put the left armrest down.
- Swivel the seat to the right until it just contacts the steering wheel, then slide the seat ahead all the way.
- Lift the recliner lever and let the seat back tilt ahead to clear the steering wheel.
- Swivel the seat the rest of the way to face the living area.
- Tilt the steering wheel down.
- Reverse the procedure to face the seat forward.



## SECTION 3 - DRIVING YOUR MOTORHOME

---

---

### SEAT BELTS

Seats intended for occupancy while the vehicle is in motion are equipped with seat belts for the protection of the driver and passengers.

#### Lap Belts

The lap belts must be worn as low as possible and fit snugly across the hip area. Always sit erect and well back into the seat. To gain full protection of the safety belt, never let more than one person use the same safety belt at any one time, and do not let the safety belts become damaged by pinching them in the doors or in the seat mechanism. After any serious accident, any seat belts which were in use at the time must be inspected and replaced if necessary.

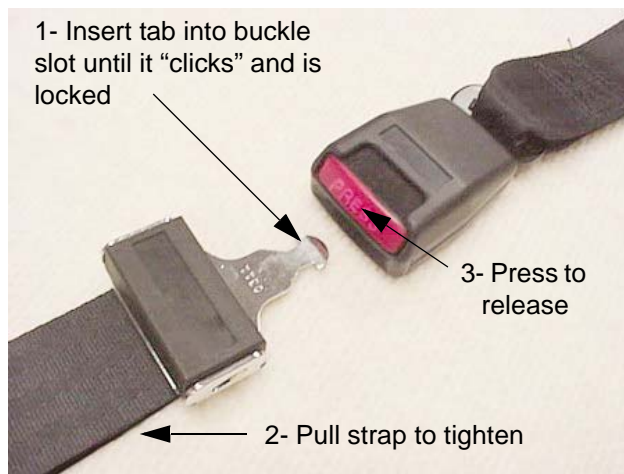

#### Adjustment

To lengthen belt, swivel the tab end at a right angle to belt and pull strap to desired length. To shorten, pull loose end of belt.

#### To Fasten

Be sure belt is not twisted. Grasp each part of the belt assembly and push tongue into buckle. Adjust to a snug fit by pulling the loose end away from the tongue.

#### To Release

Press button in center of buckle and slide tongue out of buckle.

### ! WARNING

Snug and low belt positions are essential. This will ensure that the force exerted by the lap belt in a collision is spread over the strong hip area and not across the abdomen, which could result in serious injury.

Only seats equipped with seat belts are to be occupied while vehicle is in motion. Swivel seats must be in the locked, forward facing position while vehicle is in motion.

#### Lap/Shoulder Belts

##### Fastening

Hold the belt just behind the tongue. Next, bring the belt across the body and insert the tongue into the buckle until the latch engages.

##### Unfastening

Press the release button in the buckle. Hold onto the tongue when you release it from the buckle to keep it from retracting too rapidly.

When the lap-shoulder belt is in use, the lap belt must ride low across the hip area and the shoulder belt must ride diagonally over the shoulder toward the buckle.

The shoulder belt is designed to lock only during a sudden stop, sudden body movement or a collision. At all other times it will move freely with the occupant.

### ! WARNING

Never wear the shoulder belt in any position other than as stated above. Failure to do so could increase the chance or extent of injury in a collision.

#### Seat Belt Care and Cleaning

- Be careful not to damage the belt webbing and hardware. Take care not to pinch them in the seat or doors.



- Inspect the belts and hardware periodically. Check for cuts, frays, and loose parts. Damaged parts should be replaced. Do not remove or modify the belt system.
- Keep belts clean and dry. If the belts need cleaning, use only a mild soap and water solution. Do not use hot water. Do not use abrasive cleaners, bleach, or dyes. These products may weaken the belts.
- Replace any belt assembly that was used during a severe impact. Replace the complete assembly even if damage is not apparent.

---

---

## CHILD RESTRAINTS

### -If Equipped

A properly installed and secured child restraint system can help reduce the chance or severity of personal injury to a child in an accident or during a sudden maneuver. Children may have a greater chance of being injured in an accident if they are seated in a child restraint system which is not properly secured.

A child restraint system is designed to be secured in a vehicle seat by a lap belt or the lap belt portion of a lap-shoulder belt.

When purchasing a child restraint system, follow these guidelines:

1. Look for the label certifying that it meets all applicable safety standards.
2. Make sure that it will attach to your vehicle and restrain your child securely and conveniently so that you are able to install it correctly each time it is used.
3. Be certain that it is appropriate for the child's height, weight, and development. The instructions and/or the regulation label attached to the restraint typically provides this information.
4. Review the instructions for installation and use of the restraint. Be sure that you understand them fully and can install the restraint properly and safely in your vehicle.

## Tether Anchor Loop

### -If Equipped

If your coach has a dinette, it may be equipped with a child seat tether anchor loop located on the floor or wall directly behind the forward facing dinette seat.



*NOTE: The dinette table must be in the lowered position when a child seat is in use.*



1. Lower the dinette table.
2. Route the tether over the top of the dinette seat back and hook it to the anchor loop on the floor.
3. Fasten the lap belt.

## Further Information

See the child seat manufacturer's specific instructions for proper attachment and adjustment of the tether and seat belts.

---

---

## KEYS

Your motorhome is supplied with several keys. In addition to the chassis manufacturer's ignition key, you receive keys for the entrance door and exterior compartment doors.

## SECTION 3 - DRIVING YOUR MOTORHOME

Keys have an identification number, either a small metal tag or stamped into the key head. These numbers are recorded on the vehicle's component model/serial sheet, which is included in your InfoCase. In case keys are lost or stolen, your dealer or a locksmith can provide you with duplicate keys or modify the locks.

---

---

### REARVIEW MONITOR SYSTEM

#### -If Equipped

Your coach may be equipped with a Rearview Monitor System, which lets you see what is directly behind your vehicle for maneuvering assistance and safety.

A microphone built into the rear camera lets you hear warning sounds or verbal directions from an assistant.

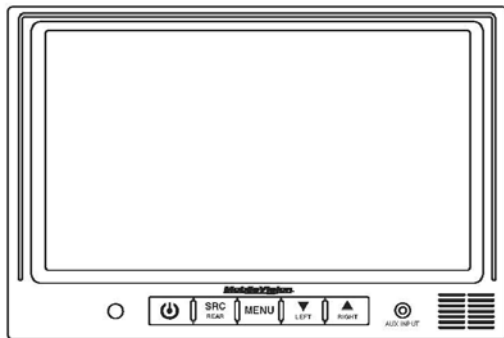

Rearview Monitor  
(Located on dash)

*NOTE: A Rearview Monitor System remote control is provided in your InfoCase.*

### Sideview Cameras

#### -If Equipped

The Sideview Cameras allow you to see what is beside you before turning or changing lanes.

The Sideview Cameras activate with the corresponding turn signals and replace the rear camera view on the monitor until the turn is completed or the signal lever is canceled manually.

### Further Information

See the Rearview Monitor manufacturer's user guide provided in your InfoCase for complete features, operating instructions, and safety precautions.

---

---

### MIRRORS - POWER ELECTRIC

#### -If Equipped

Always adjust mirrors for maximum rear visibility before driving off. Make sure the seat is adjusted for proper vehicle control and that you are sitting back squarely into the seat.

#### Mirror Adjustment Control

The mirror control is located on the driver side armrest panel or the dash. The ignition key must be on to adjust the mirrors.

Move Selector Switch L or R to select mirror. Center "neutral" position disables arrows to avoid unintentionally moving a mirror.

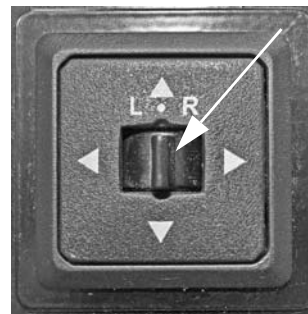

Press Arrow Buttons to move mirror surface in direction indicated.

### Mirror Heaters

The mirrors may also contain heating elements to de-fog or de-ice the mirror glass during cold weather operation. A switch for the mirror heaters is located on the dash. To turn on, press the switch UP. Press DOWN to turn off.



Mirror Heat Switch  
(Located on dash)  
-Typical View

### Mirror Arm/Head Adjustment

If you cannot adjust a mirror properly using the control switch, the mirror may need a coarse adjustment by rotating the mirror head.



Mirror Head Pivot Lock

- Loosen Allen head set screws to pivot mirror head.
- Torque 75-100 in./lbs.

*NOTE: Set screws may be located on the opposite side of the mirror arm. Passenger side mirror is similar.*

---

---

### BRAKE-SHIFT INTERLOCK

#### Ford® Chassis

The Brake-Shift Interlock is a safety feature that prevents the shift lever from being moved from the Park position unless the ignition is ON and the service brake pedal is pressed.

*NOTE: If the brake light fuse is blown, the interlock feature will not work properly and an alternate method must be used. See the chassis manual provided in your InfoCase for detailed instructions on what to do in this situation.*

---

---

### PARK BRAKE – FOOT PEDAL

#### Ford® Chassis

The park brake foot pedal and release lever are located beneath the left side of the dash.

Step the pedal down fully to apply and pull the brake release knob to disengage.

---

---

### TOW/HAUL TRANSMISSION MODE

#### Ford® Chassis only

This mode locks out Overdrive and helps reduce gear “hunting” by the automatic transmission while towing. It also improves power delivery and uses engine braking to help control vehicle speed when descending hills.

This mode may also be useful when the coach is fully loaded or when driving into a strong headwind.



- Press the button at the end of the shift lever to engage Tow/Haul Mode when pulling a trailer or tow vehicle

## SECTION 3 - DRIVING YOUR MOTORHOME

### Further Information

See the chassis manual in your InfoCase for further operating instructions and cautions.

---

---

### MAP LIGHT SWITCH

Your vehicle is equipped with a driver side Map Light for your convenience.

Turn the driver side Map Light on using the light dimmer wheel (located on dash). Roll it up to maximum position until you feel it click into the Map Light “On” position.

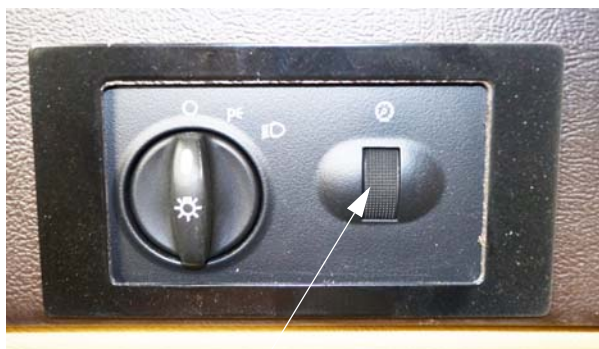

Driver Side Map Light Switch  
(Located on dash)

- Roll light dimmer wheel upward fully to turn driver side Map Light on

### Further Information

Refer to the chassis manual provided in your InfoCase for more information on the driver side Map Light switch.

---

---

### HAZARD WARNING FLASHERS

The hazard warning flashers provide additional safety when the vehicle must be stopped on the side of the roadway and presents a possible hazard to other motorists. When the flashers are on, it serves as a warning to other drivers.

### Further Information

See your chassis manual for instructions on activating, operating, and canceling hazard warning flashers.

---

---

### BATTERY BOOST SWITCH

This switch can be used to draw emergency starting power from the house batteries to start the engine if the chassis battery is discharged.

Press and hold in the UP position while turning ignition key for emergency starting power.

*NOTE: The House/Coach Battery Disconnect switch near the entrance door must be ON and house batteries must be sufficiently charged for this feature to work.*



Battery Boost Switch  
(Located on dash)  
-Typical View

---

---

### AIR CONDITIONER/HEATER – AUTOMOTIVE (DASH)

Controls for the air conditioner, heater, defroster, and vent are located on the dash.



Blower  
Control

Temp  
Control

Mode  
Selector

-Typical View



*NOTE: The dash air conditioner/heater is not designed to heat and cool the entire interior of the coach, but is intended only to provide heating and cooling for the cab area.*

*A small amount of air will blow out of all of the defrost and dash vents regardless of the mode setting.*

## Further Information

See the manufacturer's user guide provided in your InfoCase for complete operating instructions.

---

## RADIO POWER SWITCH

The Radio Power switch lets you connect the dash radio to the coach batteries with the ignition switch turned off for listening while parked. This prevents accidental draining of the chassis battery with prolonged use of the radio.

*NOTE: The House/Coach Battery Disconnect switch must be ON while listening to the dash radio because the audio relay is powered by house batteries. If the House/Coach Battery Disconnect switch is off, the speakers will not emit sound.*



Radio Power Switch  
(Located on dash)  
-Typical View

- Press DOWN to run radio off of the house battery (the ignition key does NOT need to be turned on).
- Press UP to run radio off of the chassis battery.

---

## RADIO – IN-DASH

-If Equipped



## Further Information

Please refer to the manufacturer's operating guide in your InfoCase for detailed instructions on programming preset station buttons and using this system.

---

## FRONT SERVICE ACCESS (HOOD)

The hood panel can be opened for access to service items such as:

- Windshield Washer Fluid Reservoir
- Brake Fluid Reservoir
- Generator Oil Dipstick

Release the hood by lifting up on the latches (located on each side of interior hood), then pull the hood panel outward and raise it into the open position.



(Lift up the latches on each side of interior hood and raise)  
-Typical View

## SECTION 3 - DRIVING YOUR MOTORHOME

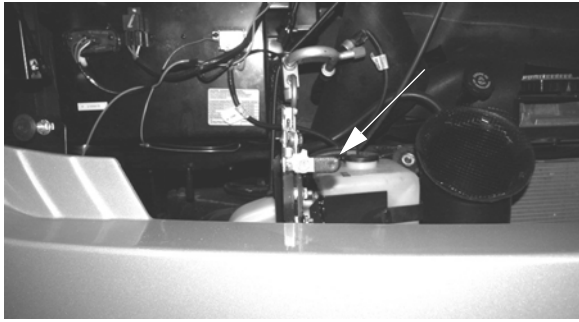

Front Hood Latch



To close, pull hood down and push in with palms of hands on sides to secure latches. You will hear the hood latches “click” when engaged in the locked position.

---

---

### ENGINE ACCESS – INTERIOR Front Engine Cover (Located between cab seats)

*NOTE: Take precautions to protect carpet and interior furnishings when removing engine cover. The underside of the engine cover could contain deposits of oil and fuel or other engine fluids and substances that could damage fabrics and interior furnishings.*

- **To remove the engine cover**, insert the supplied hex wrench into the hole (located on the top center **or** the front edge of the engine cover, depending on model).
- Turn the hex wrench to the left (counter-clockwise) to unlock.

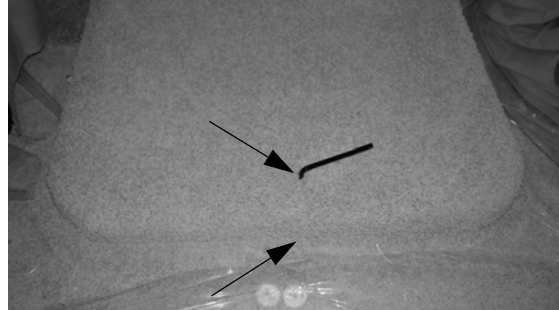

- Insert hex wrench into the hole located on the top center of the engine cover (as shown) **or** the front edge of engine cover (depending on model) to unlock.

-Typical installation shown

*NOTE: On certain models, there may also be additional screws to remove at the lower front corners on each side of the engine cover. See following photo.*

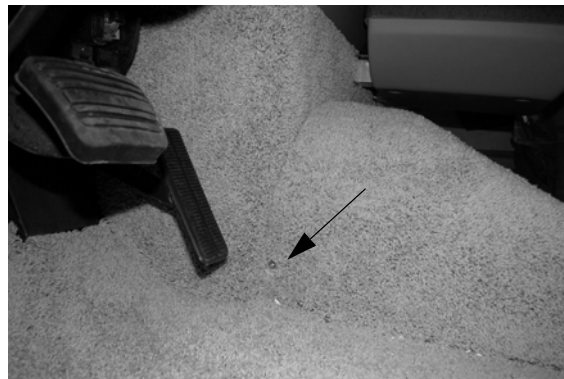

- Remove screws at the lower front corners on each side of the engine cover (if equipped).
- Typical installation shown
- Remove engine cover and set aside.



-Typical View

*NOTE: If your coach is featured with a beverage tray, it may need to be removed to provide additional clearance before removing the engine cover.*

*If the beverage tray is equipped with a drawer, it must be removed to expose the fasteners that hold the tray to the engine cover.*

- **To reinstall the engine cover**, position the front end of the cover first, then lower the rear end.

*It is important to ensure the front edge is pushed completely forward to the radiator cover to ensure an air-tight seal.*

- Press the rear end of the engine cover down and turn the hex wrench to the right (clockwise) until the latch pulls the cover downward and stops.
- Reinstall the screws at the lower front corners on each side of the engine cover (if equipped).

---

---

## ENGINE COOLING SYSTEM

Do not remove the radiator cap while engine and radiator are still hot. Always check coolant level visually at the see-through coolant reservoir.

*NOTE: Your chassis engine cooling system is filled with special extended-life coolant that is not the same as common anti-freeze available at retail outlets. The coolant system **MUST** be refilled or topped up with the same type of coolant as equipped to maintain the special long-life properties.*

### NOTICE

When refilling the coolant system of a vehicle equipped with a rear auxiliary automotive heater and motoraid water heater, be sure to allow for additional coolant capacity of the heater and its supply and return hoses.

## Further Information

Refer to the chassis manual in your InfoCase for information and precautions on filling, servicing, and checking the fluid level.

---

---

## TIRES

Improper tire pressure can result in tire overloading and abnormal wear and also affects handling, ride characteristics, and fuel economy.



### WARNING

Make sure all replacement tires are of the same size and rating as those shown on your Vehicle Certification Label.

---

---

## SUSPENSION ALIGNMENT AND TIRE BALANCE

The front suspension and steering system of this vehicle was factory aligned using highly accurate equipment prior to delivery to the dealership. However, alignment should be checked and adjusted after you have fully loaded the motorhome according to your personal needs. Thereafter, the alignment should be periodically inspected to help prevent uneven tire wear.

Any excessive or abnormal tire wear may indicate worn or misaligned suspension or steering, unbalanced tire, or other tire/suspension problem.

Alignment can be affected by worn steering/suspension parts or by incidents which happen during driving, such as hitting a curb, pothole, or railroad track, etc. Improper alignment can cause tires to roll at an angle and wear unevenly. It may also cause the vehicle to “pull” to the right or left. Have your dealer inspect your vehicle’s suspension and steering components periodically for misalignment or wear.

Out-of-balance tires will not roll smoothly and can lead to vibrations and uneven tread wear, such as cupping and flat spots. Tires may need to be balanced if uneven wear is detected or if ride comfort decreases noticeably.

## SECTION 3 - DRIVING YOUR MOTORHOME

---

### Further Information

See the chassis manual in your InfoCase for further information.

---

---

### LIGHTS

All exterior lights should be checked for proper operation each time the vehicle is prepared for a trip. Any bulbs which fail to light should be checked and replaced, when necessary, with a new bulb of the same size. A failure of more than one light, such as both taillights not operating, may indicate a burned out fuse. Check fuse and replace with one of the same rating when necessary. If a fuse is not the cause of the problem, the wiring system should be checked immediately by an authorized service center.

### Further Information

Refer to the chassis manual in your InfoCase for further information.

---

---

### CIRCUIT BREAKERS AND FUSES – CHASSIS/DASH AUTOMOTIVE 12-VOLT

The 12-Volt Automotive Fuses and Circuit Breakers are conveniently located beneath the left end of the dash in front of the driver seat.

The circuit breakers will pop outward if they are tripped. Simply push in to reset. Always replace plug-in blade fuses with ones of the same size and amperage rating/color.



Automotive 12-Volt  
Circuit Breakers and Fuses  
(Located beneath left end of dash)  
-Typical View

### Further Information

Refer to the chassis manual provided in your InfoCase for additional information about chassis-supplied fuses and circuit breakers.



## SECTION 4 - APPLIANCES AND SYSTEMS

---

The appliances installed in your motorhome are manufactured by reputable RV appliance makers and have been tested by independent laboratories to meet all applicable standards and codes set for RV appliances.

See *Section 2 - Safety and Precautions* of this manual for any safety and precautions you need to take regarding the operation of your appliances.

---

### REFRIGERATOR

#### -If Equipped

The refrigerator in your coach can operate from either of two energy sources available to the motorhome:

- 120-Volt AC Electric
- Propane Gas

To be able to use both types of energy, the refrigerator does not have a compressor like household refrigerators. Instead, it uses an ammonia-water solution for cooling. Basically, ammonia vapor is distilled from the solution by heat produced from either propane gas flame or electrical heat element. The ammonia vapor is then carried to the finned condenser where it liquefies. The liquid then flows to an evaporator where it creates cooling by evaporation. The ammonia circulates back into the water solution and the cooling cycle continues.

#### Leveling

Before operating the refrigerator when the motorhome is stationary, place a small level on the bottom of the refrigerator and make certain the unit is level. If over 1/2 of the bubble is inside the circle in any direction, the coach is level enough for continuous operation of the refrigerator while parked.



Place bubble level in bottom of refrigerator

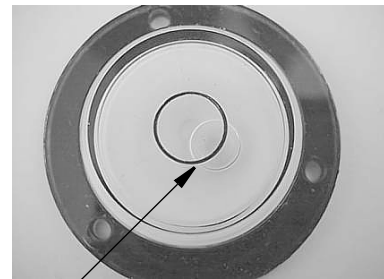

Bubble must be at least 1/2 inside circle

Normal vehicle leveling to provide comfort for the occupants is satisfactory for refrigerator operation.

### NOTICE

To prevent permanent damage to the refrigerator cooling unit, turn the refrigerator off if the vehicle will be parked on an incline of over 3° side-to-side or 6° front-to-rear (such as steep driveways or parking lots, etc.) for more than one hour.

#### Basic Operation

Slide the control switches to the operating positions described and observe the indicator lights.

## SECTION 4 - APPLIANCES AND SYSTEMS

---



- **Gas-** Refrigerator will operate on gas from the propane tank if the main valve is open and the tank contains gas.
- **Auto-** Refrigerator will operate on 120-VAC household current if the shoreline is connected or the auxiliary generator is running. If electricity is lost, it will automatically switch over to Gas operation if gas is available.
- **Temperature Setting-** Start at the coldest setting to ensure coldest temperature in the freezer compartment, then adjust warmer as necessary after cold\* food has been added.
- **“On” Indicator Light-** Glows steady when refrigerator is operating properly.
- **“Gas” Indicator Light-** Will flash if gas is not available. To operate the refrigerator you must provide 120VAC then switch to Auto operation.

\* *The refrigerator will retain temperature more efficiently if food is cold before placing inside.*

### Further Information

For further information and operating cautions, see the refrigerator operating instructions included in your InfoCase.

---

---

## REFRIGERATOR SERVICE ACCESS COMPARTMENT (Exterior)

The exterior refrigerator service compartment allows access to the rear of the refrigerator for inspection, maintenance, and service.

### To Open

1. Use a screwdriver or coin to turn the latch knobs to the vertical position as shown.



• CLOSED



• OPEN

Refrigerator Access Door Latches

2. Remove the door from the opening.

### To Close

1. Replace the door into the opening.
2. Push the latch knobs in while turning to the horizontal position as shown.



Refrigerator Access Compartment  
-Typical View

---

---

## RANGE AND OVEN -If Equipped

The Range and optional Oven in your motorhome operate on propane gas and will provide most of the functions of the range in your home.



**To Light Range Top Burners**

- Turn the desired burner knob counter-clockwise to the ON or LITE position (do NOT attempt to light more than one burner at a time).
- Turn the SPARK knob clockwise one “click”.

*NOTE: If the burner fails to light, continue turning the SPARK knob clockwise until the burner lights.*

- To extinguish the burner flame, turn desired burner knob clockwise to OFF.

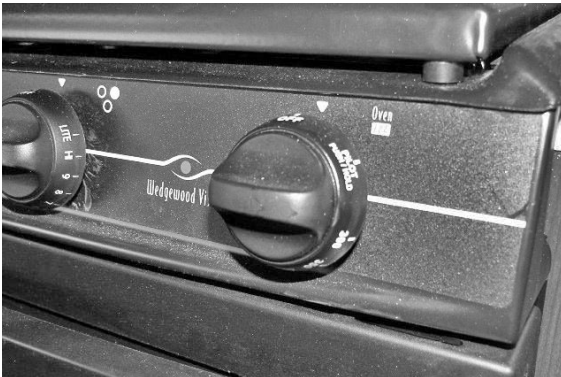

**Oven Burner Knob  
-If Equipped**

- PILOT ON position keeps pilot flame lit for repeated use of Oven while vehicle is parked.
- Turn Oven knob to PILOT OFF position while traveling or refilling propane gas tank.

**To Light Oven Pilot**

- See “Oven Operation” in the manufacturer’s user guide provided in your InfoCase.

**Avoiding Asphyxiation**

The following warning label has been located in the cooking area to remind you to provide an adequate supply of fresh air for combustion.

**⚠ DANGER**

Do not use gas cooking appliances for comfort heating. May lead to carbon monoxide poisoning, which can lead to death or serious injury.

**⚠ WARNING**

Gas cooking appliances need fresh air for safe operation.

Before operating:

Open vents or windows slightly or turn on exhaust fan prior to using cooking appliance. Gas flames consume oxygen, which should be replaced to ensure proper combustion. Improper use may result in death or serious injury.

Unlike homes, the amount of oxygen supply is limited due to the size of the recreational vehicle, and proper ventilation when using the cooking appliances avoids dangers of asphyxiation.

It is especially important that cooking appliances not be used for comfort heating, as the danger of asphyxiation is greater when the appliance is used for long periods of time.

**FAILURE TO COMPLY COULD RESULT IN DEATH OR SERIOUS INJURY.**

**⚠ WARNING**

Portable fuel-burning equipment including wood and charcoal grills and stoves, shall not be used inside the recreational vehicle. The use of this equipment inside the recreational vehicle can cause fires or asphyxiation. Failure to comply could result in death or serious injury.

## SECTION 4 - APPLIANCES AND SYSTEMS

---

### Further Information

See the appliance manufacturer's user guide provided your InfoCase for complete operating instructions and safety precautions.

---

### MICROWAVE OVEN

#### -If Equipped

Refer to the manufacturer's user guide located inside the appliance for complete operating instructions.



Microwave Oven - Typical  
(brand, model, and appearance  
shown may vary from your model)

### RANGE HOOD

#### -If Equipped

The range hood vent draws cooking odors and airborne grease particles into the filtration grid and either recirculates the air or vents it to the outside of the coach, depending on model.

A light on the underside of the hood provides illumination for cooking and food preparation.

### Further Information

See the manufacturer's user guide provided in your InfoCase for instructions on replacement of light bulbs and replacement or cleaning of grease filter elements.

---

### SYSTEMS MONITOR PANEL

The Systems Monitor Panel provides a convenient central location for checking the condition of all utility systems in your coach.



At the touch of a button, this panel will display the fresh water and holding tank levels, propane gas tank level, plus the house battery condition. You can start the generator or turn on the water pump and water heater. Indicator lights tell you if the water pump is on or if the water heater pilot light is out.

### Water And Holding Tank Levels

Press and Hold the "Levels Test" switch to show approximate level on the monitor lights.



The approximate fluid levels are measured by electronic sensors on the sides of the tanks. There is generally more fluid in a tank than indicated on the monitor panel.

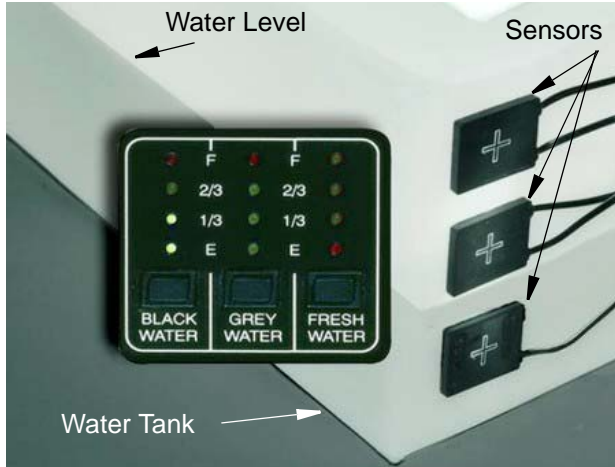

For example, if the fluid level is 1-2" below the FULL sensor, the monitor will show the level to be only 2/3 even though the tank is nearly full.

If a tank is about 1/4 full, the monitor will register an empty tank because the fluid level is below the 1/3 sensor even though there is still fluid in the tank.

However, when the indicator reads FULL, the tank is actually full.

### Tank Capacities

See "Tank Capacities" in *Section 1 - Introduction*.

### Propane Gas Level

Press and Hold the "Levels Test" switch to show approximate propane tank level.

The propane level is registered by a sending unit on the tank. The gauge mounted on the side of the tank will give a more accurate indication of actual tank level if needed.

### Battery Charge Meter

Press and Hold the "Levels Test" switch to check the level of charge (voltage) in the 12-volt house battery.

The colored segments (red, yellow, and green) will light from the bottom up to the amount of charge the battery contains.

- Green - good or adequate charge.
- Yellow - marginal charge.
- Red - battery needs charging before use.

To get an accurate reading:

1. Both the chassis engine and the generator engine must be shut off and 120-volt AC shoreline unplugged.
2. An interior light should be turned on to provide a small load which draws off the battery surface charge.

### Water Pump Switch

When use of the self-contained water system is desired, turn the "Water Pump" switch on. The "Pump On" light will illuminate when the pump switch is on and the system is operable. Water will be available as soon as a faucet is opened. Refer to "Water Pump" for additional information on the water pump and initial start-up.



*NOTE: Some models may be equipped with a Water Pump switch in the water service center on the outside of the coach or within the bathroom area for your convenience.*

---

## WATER HEATER – GAS

### –If Equipped

*NOTE: Read the Water Heater operating guide provided in your InfoCase for complete operating instructions, safety warnings, and maintenance information before operating the Water Heater.*

**Ensure the Water Heater is filled with water before operating.**

To fill the Water Heater, turn the Water Pump switch ON and open a hot water faucet anywhere in the coach. When water begins to flow steadily from the faucet, the Water Heater is full.



## SECTION 4 - APPLIANCES AND SYSTEMS

### Propane Gas Operation

- Press the Water Heater switch (located on the Systems Monitor Panel) to the ON position.



- The “Pilot Out” light will glow for about 10-15 seconds, then it will go out. The “Heater On” indicator will remain lit.
- If the “Pilot Out” light comes on during operation, it means that the burner has gone into “lockout” mode and must be restarted. If this happens, turn the Water Heater switch OFF for approximately 5 minutes, then turn back on.

### Further Information

See the Water Heater manufacturer’s operation manual provided in your InfoCase for complete operating instructions, safety warnings, and maintenance information.

---

---

## PRESSURE-TEMPERATURE RELIEF VALVE

### -If Equipped

On occasion, water may be seen seeping from the water heater pressure temperature relief valve. This is no cause for repair or replacement of the valve.

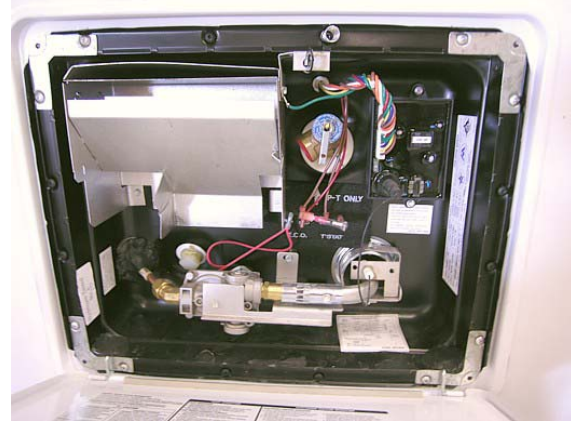

Water Heater Exterior Service Access  
-Typical View

Normally there is an air gap at the top of the water heater tank, which acts as a pressure buffer. In time, however, heated water may expand and fill this air gap, causing a slight increase in water pressure. This may cause the P-T valve to “weep” until the air gap is manually replaced.

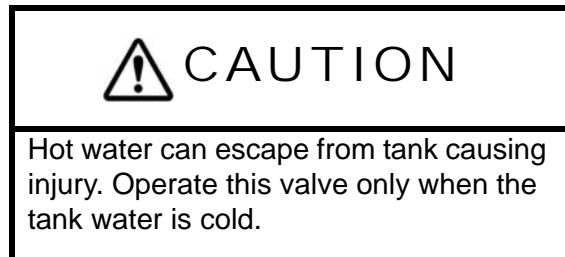

### To Replace the Air Gap:

1. Turn off the Water Heater switch and incoming water supply (city water and/or demand pump).
2. Open a faucet in the motorhome to relieve water pressure.
3. Pull the handle of the P-T valve straight out and allow water to flow until it stops.

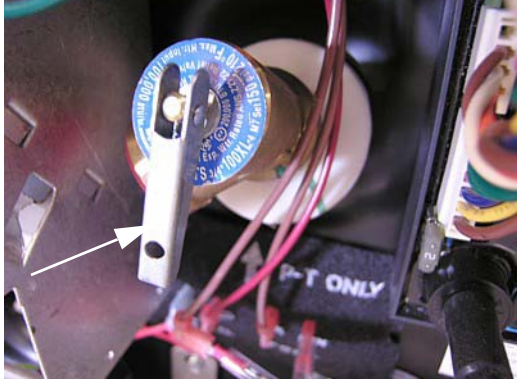

- Lift handle straight out to open P-T valve when water heater is cold  
-Typical View

4. Let the handle of the P-T valve snap shut.
5. Close the faucet and turn on the water supply before switching the water heater on.

Manually operate the pressure temperature relief valve at least once a year.

*NOTE: If your water heater is equipped with the motoraid system, it uses an extension from the engine cooling system to heat water in the water heater while driving. The engine cooling system must also be cold before opening the pressure-temperature relief valve. See "Motoraid Water Heater" for more information.*

## PROPANE GAS FURNACE

### To Start Up

1. Open the LP gas tank valve by turning fully counter-clockwise.



Temp Selector

- Slide to select temperature
2. Move SYSTEM switch from Off to Heat and set the desired temperature using the Temp Selector slider.
  3. Furnace fan should start to blow immediately after setting the thermostat.
  4. After about 30 seconds, the furnace burner should light.
  5. The furnace should now cycle off and on automatically as the thermostat demands just like a household furnace.

*NOTE: If heat does not come out of the heat ducts after a minute or so the burner is not lit.*

*Turn thermostat off for 3-5 minutes, check to be sure propane gas tank valve is open and tank is not empty, then try steps 2-4 again.*

*If the furnace will not light after three attempts, go to Shut Down steps and contact your dealer or a local RV service center for repair.*

### To Shut Down

1. Slide thermostat switch to Off position.
2. Close propane tank valve if coach will be stored for a period of time.

### Further Information

Please see the furnace operating instructions provided in your InfoCase for further information, including operating precautions,

## SECTION 4 - APPLIANCES AND SYSTEMS

---

and periodic maintenance. See the Coach Maintenance Schedule for recommended intervals.

*NOTE: If the furnace burner has any residuals of metal protectant or lubricants used during manufacture of the furnace, it may smoke slightly when the furnace is used for the first time and may set off your smoke alarm.*

*We recommend that you provide adequate ventilation when using the furnace for the first time to avoid a nuisance smoke alarm.*

*We do not recommend removing the smoke alarm battery.*

It is recommended to check the filter monthly for dirt build-up and cleaned or replaced, as necessary.

---

---

### DUCTED ROOF AIR CONDITIONING SYSTEM

The furnace thermostat also controls ducted roof air conditioner operation when the Thermostat switch is placed in “Cool” position.

All cooling functions controlling to setpoint have a short cycle protection time delay of three minutes. There will be no delay if the cycle OFF time exceeds three minutes.

*NOTE: The ducted roof air conditioning system has ceiling registers that can be closed if necessary to force more cool air toward a specific area of the coach or to route cool air away from a specific area. If too many vents are closed, however, it can cause the air conditioner unit to shut down, particularly in high humidity conditions.*

### Further Information

Refer to the manufacturer’s user guide provided in your InfoCase for complete operating instructions.

---

---

### AIR CONDITIONER FILTER

The washable foam air conditioner filter is located in the ceiling-mounted return A/C grille in the lounge area of the coach.



# SECTION 5 - PROPANE GAS

## PROPANE GAS SUPPLY

The propane gas system supplies fuel for the gas range/oven, water heater, furnace, and refrigerator (while in gas mode). When used and handled properly, this system is safe and economical and provides modern living conveniences wherever you travel.

See *Section 2 - Safety and Precautions* in this manual for other safety and precautions you need to be aware of related to propane.

## How Propane Gas Works

Propane is a type of LP (Liquefied Petroleum) gas compressed into liquid form for easy transportation and storage. Propane gas may also be called tank gas, bottle gas, or simply LP.

Propane is used by appliances in vapor form only, but is stored in the tank as a liquid under very high pressure. As the liquid gas is released, it reverts back to a vapor and expands to many times its compressed volume.

## Propane Tank System

The storage reservoir for the propane gas system is a horizontally mounted tank which is permanently attached to the vehicle frame. The tank is accessible only from the outside of the vehicle.

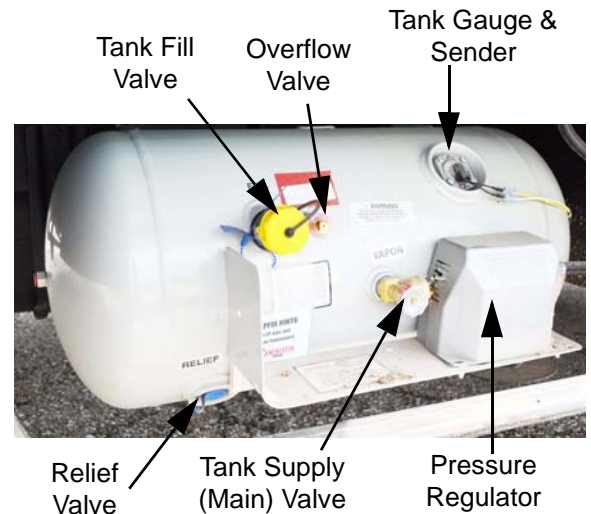

Propane Tank Features  
-Typical View



## WARNING

Do not alter or remove propane tank valves or gauge. Propane can escape, which can cause an explosion resulting in death or serious injury. Have the propane system serviced by a qualified service center.

## Refilling Propane Tank

Since the propane tank is permanently mounted to the frame, the motorhome must be taken to a propane dealership for filling. Do not attempt to remove the propane tank from the vehicle. The tank is equipped with a fill adapter with both internal and external threads, which allows easy filling with any propane filling equipment. The tank is full when liquid propane gas appears at the overflow valve.

*NOTE: The propane tank is equipped with an automatic 80% stop-fill device.*

## SECTION 5 - PROPANE GAS

---

### WARNING

Do not fill propane container(s) to more than 80 percent of capacity. A properly filled container contains approximately 80 percent of its volume as liquid propane. Overfilling the propane container(s) can result in uncontrolled propane flow, which could lead to a fire or explosion and result in death or serious injury.

### DANGER

All pilot lights, appliances, and their igniters (see operating instructions) shall be turned off before refueling of motor fuel tanks and/or propane containers. May cause ignition of flammable vapors, which can lead to a fire or explosion and result in death or serious injury.

### WARNING

This propane piping system is designed for use with propane only. Do not connect natural gas to this system. Securely cap inlet when not connected for use. After turning on propane, except after normal cylinder replacement, test propane piping and connections to appliances for leakage with soapy water or bubble solution. Do not use products that contain ammonia or chlorine to test for leaks. May lead to a fire or explosion, which could result in death or serious injury.

### Selecting Propane Fuel Types

We recommend using straight propane in your propane tank. Propane gas is commonly available at all propane gas outlets in the U.S. (According to the National Propane Gas Association,

propane gas outlets in the United States do not offer any other type of liquefied petroleum gas than propane to the general public.) Check local phone directory yellow pages for locations of local propane gas refilling stations or bulk dealerships.

*NOTE: If you travel outside the U.S. with your motorhome, you may find butane or propane/butane mixtures available in addition to propane. Because gas-burning RV appliances are designed to run on propane only, we recommend that you request straight propane only. Butane burns about 30 percent hotter than propane and can overheat some appliances, particularly refrigerators, and cause permanent damage. Other appliances designed to operate on propane can become sooted and lose efficiency by using butane fuel.*

### Air in the Propane Gas Tank

If your gas appliances do not stay lit or require frequent adjustment, even though you know the propane tank contains sufficient fuel, the problem may be air in the propane gas tank. Air in the tank mixes with the propane gas vapors causing them to burn poorly. This condition could linger for weeks if the air is not purged from the tank. Most propane gas dealers have equipment for purging air from propane gas tanks and will purge before refilling the tank.

---

---

### SAFE USE OF THE PROPANE GAS SYSTEM

The propane system is designed and built with strict adherence to national, state, and recreational vehicle industry requirements for mobile propane gas equipment.

For your safety, there are many safety devices and backup systems installed, such as tank fill overflow valves, an interior propane gas detector/ alarm, and an interior carbon monoxide (CO) detector/alarm.

Propane gas also contains an odor additive that you can smell if propane is present in the air.

Here are a few precautions to observe that will help you to use the propane gas system safely:

- Exercise caution at all times. Be familiar with the distinctive odor of propane gas. If a leak is suspected, turn off the supply valve immediately. Have the propane gas system checked by your dealer or other qualified propane gas service center.
- Do not tamper with the propane gas piping system, pressure regulator, or gas appliances. Service and maintenance of propane gas system components should be performed only by your dealer or a qualified propane gas service center.
- Never attempt to connect natural gas to the propane gas system.
- Have the entire propane gas system inspected for possible leaks and missing or damaged parts at each tank filling. Also inspect before and after each trip, and any time trouble is suspected.
- Turn the propane supply valve off when not using the propane gas system.
- Never use a wrench to tighten the tank supply valve. It is designed to close leak-tight by hand. If a wrench is required to completely close the valve, it is defective and must be replaced.
- Be sure appliance and outside vents are open and free from obstruction when using the propane gas system.
- Never attach a lock or any device requiring a key to the propane tank compartment door. According to standards set for recreation vehicles, the propane supply valve must be readily accessible in an emergency.
- Exercise caution when drilling holes or attaching objects to the walls. Gas lines and electrical wiring could be seriously damaged and present an extreme safety hazard.

---

---

## PROPANE GAS WARNINGS AND PRECAUTIONS

It is illegal for vehicles equipped with propane tanks to travel on certain roadways or through certain tunnels in the U.S. To avoid inconvenience, check state regulations concerning flammable gas transportation.

### Propane Gas Leaks

The following label is located in the vehicle near the range area. If you smell gas within the vehicle, quickly and carefully perform the procedures listed.

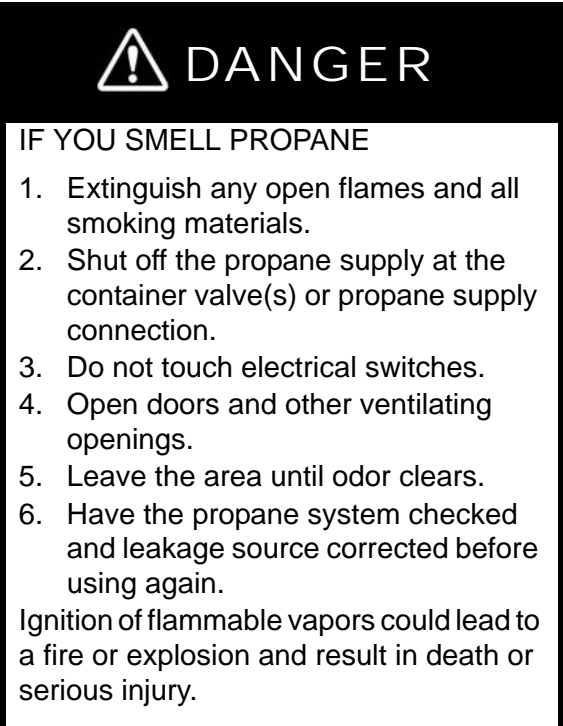

**! DANGER**

**IF YOU SMELL PROPANE**

1. Extinguish any open flames and all smoking materials.
2. Shut off the propane supply at the container valve(s) or propane supply connection.
3. Do not touch electrical switches.
4. Open doors and other ventilating openings.
5. Leave the area until odor clears.
6. Have the propane system checked and leakage source corrected before using again.

Ignition of flammable vapors could lead to a fire or explosion and result in death or serious injury.

- All pilot lights must be extinguished and appliances and their ignitors turned off while refilling the fuel tank or propane tank.
- Never smoke while refilling vehicle fuel tank or propane gas tank.
- Avoid inhaling exhaust gases produced by burned gasoline, diesel fuel, or propane gas in items such as the range, chassis engine, generator engine, refrigerator, furnace, and water heater. They contain carbon monoxide, which is an odorless, colorless, and poisonous gas.

## SECTION 5 - PROPANE GAS

---

### WARNING

Propane cylinders shall not be placed or stored inside the vehicle. Propane cylinders are equipped with safety devices that relieve pressure by discharging propane to the atmosphere. Failure to comply could result in death or serious injury.

- Never use an open flame to test for propane gas leaks. Replace all protective covers and caps on propane system after filling. Make sure valve is closed and door latched securely.
- Portable fuel-burning equipment, including wood and charcoal grills and stoves, shall not be used inside the recreational vehicle. The use of this equipment inside the recreational vehicle may cause fires or asphyxiation.
- Regulators are equipped with a protective cover. Make sure that the regulator vent faces downward and that the cover is kept in place to minimize vent blockage, which could result in excessive gas pressure causing fire or explosion.

---

### PROPANE GAS PRESSURE REGULATOR

The pressure regulator is protected from the elements by a plastic cover, which should be left in place at all times.

Propane regulators must always be installed with the regulator vents facing downward. Regulators that are not in compartments have been equipped with a protective cover. Make sure that the regulator vent faces downward and that the cover is kept in place to minimize vent blockage that could result in excessive propane pressure causing fire or explosion.

Only your dealer or a qualified propane gas service should remove the regulator cover for adjustments.

### WARNING

Visually inspect the pressure regulator vent periodically for blockage by accumulated debris or insect nests, etc. Vent obstruction could result in excessive pressure causing fire or explosion, which could result in death or serious injury. If an obstruction exists, have the regulator serviced by a qualified service center.

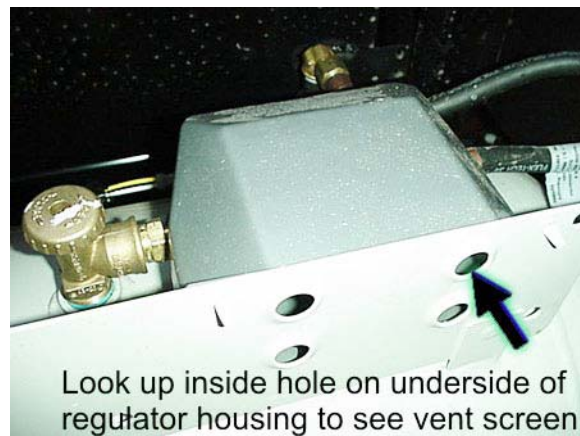
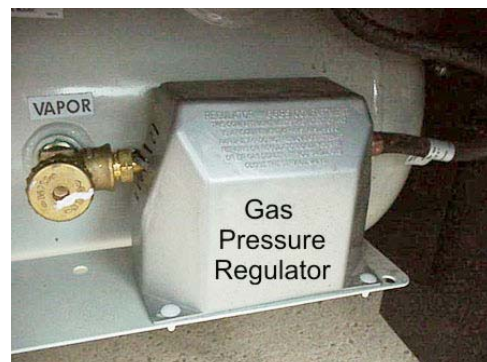

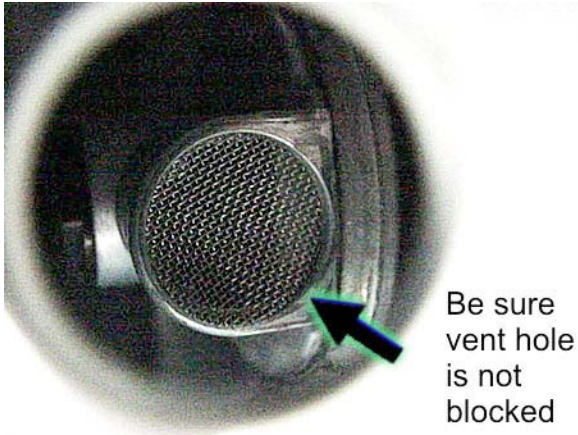

### Regulator Freeze-up

Regulator freeze-ups are caused by the presence of moisture in fuel. This moisture will pass through the cylinder valve and into the regulator where it can freeze. Fuel producers, tank and bottle manufacturers, and propane gas dealers take every precaution to reduce moisture, but sometimes only a fraction of an ounce entering the tank can cause problems. To help avoid the possibility of freeze-up, always keep tank control valve closed when not in use, even when tank is empty, to prevent moisture from collecting on the inside.

If regulator freeze-up should occur, you may attempt to thaw the regulator using a light bulb. **DO NOT USE AN OPEN FLAME OR HEAT LAMP.**

If moisture begins to cause problems, have your propane gas dealer inject a small amount of dry methyl alcohol in your tank (approximately one ounce to 20 pounds or one pint to 100 gallons) to help guard against regulator freeze-ups.

---

### PROPANE VAPORIZATION IN COLD WEATHER

Propane gas vaporization increases and decreases in direct relation to ambient temperature. In other words, the lower the temperature, the slower the liquid propane will vaporize into a usable gas for appliances.

This means that in extremely cold weather when a large volume of gas is being used by the furnace for heating, it is possible to experience a loss of gas pressure.

At first, this problem may appear to be caused by an empty tank or a regulator freeze-up, but is actually caused by failure of the liquid gas to vaporize as fast as it is needed by the furnace.

The demand for propane to produce heat increases to the point where the gas cannot vaporize fast enough to keep the furnace going. The only solution to this problem is to reduce gas usage where possible.

Adjusting the temperature on the gas/electric refrigerator may be a first step. Using less hot water will also help, as well as refraining from using the gas cooktop. A final step is to lower the thermostat setting to reduce gas usage by the furnace.



# SECTION 6 - ELECTRICAL

---

Your coach is equipped with an electrical system consisting of two separate voltages:

- 12-volt DC system (battery current); and
- 120-volt AC system (household current)

The 12-volt system consists of two internal power sources, while the 120-volt system is operated from an outside power source or the optional 120-volt generator.

---

---

## ELECTRICAL CAUTIONS

- Careless handling of electrical components can be fatal. Never touch or use electrical components or appliances while feet are bare, while hands are wet, or while standing in water or on wet ground.
- Improper grounding of the vehicle can cause personal injury. Do not plug the utility power cord into an outlet which is not grounded and do not adapt the plug to connect to a receptacle for which it is not designed.
- Do not attach an extension cord to the utility power cord.
- Be sure that all electrical appliances to be used contain 3-prong plugs for proper grounding.
- Avoid overloading electrical circuits. Replace fuses or circuit breakers with those of the same size and amperage rating only. Never use a higher rated fuse or breaker.
- Use caution when handling or working near electrical storage batteries. Always remove jewelry and wear protective clothing and eye covering. Avoid creating sparks.

---

---

## ELECTRICAL SYSTEM – HOUSE 120-VOLT AC

The 120-volt system operates from the shoreline cord connected to an outside 120-volt utility service, such as those at campgrounds or from the 120-volt generator. When the shoreline cord is connected to an outside power source, or when the auxiliary electric generator is running,

the power converter automatically changes a portion of the 120-volt current to 12-volt DC current. All equipment in the motorhome that is normally powered by the house batteries is then powered through the converter.

In addition, the following equipment is entirely dependent on 120-volt current: air conditioner, refrigerator (when placed in AC mode), microwave oven, and any 120-volt electrical equipment used at convenience outlets.

---

---

## POWER CORD – EXTERNAL (Shoreline)

The external power cord (commonly referred to as a “shoreline”) is stored in the utility compartment on the left (driver’s) side of the coach.



### WARNING

Do not use an extension cord. Improper sized cords, damaged cords, and poor connections can lead to fire, which can result in death or serious injury.



### WARNING

Do not connect the external power cord to any receptacle until you have verified proper polarity and grounding. Be sure all prongs of the supply cord are properly plugged into the receptacle. Failure to observe can result in death or serious injury.

The power cord is designed to ground the electrical system through the receptacle. It is also designed to carry the amperage output of most campground outlets. If the electrical receptacle to



## SECTION 6 - ELECTRICAL

be used is designed to mate with the prongs of the power cord plug, the electrical connection can be expected to carry rated load.

### Connecting the Power Cord

To connect to an external source, remove the cord from the utility compartment and plug it into a suitable power outlet to provide external power to the coach and converter/charger system.

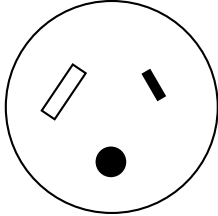

30 Amp Receptacle



### WARNING

This connection is for 110/125 Volt AC, 60 Hz 30 Ampere supply. Do not exceed circuit rating. Exceeding the circuit rating may cause a fire and result in death or serious injury.

A rotating hatch in the compartment floor lets you route the shoreline cord through a passage in the bottom of the compartment so you can shut the compartment door while the shoreline is connected.

7. Flip the retainer in the center of the cover straight up.



8. Rotate the cover to the largest hole to pass the cord end through.



9. Then rotate to the smaller opening to enclose the cord.



The power cord is designed to ground the electrical system through the receptacle. It is also designed to carry the amperage output of most campground outlets. If the electrical receptacle to be used is designed to mate with the three prongs on the power cord plug, the electrical connection can be expected to carry rated load.



### WARNING

Service inlet access must be closed when utility connections are not in use.

### Park Fuses or Breakers

Most campgrounds are equipped with a fuse or circuit breaker at the receptacle (which we recommend shutting off before engaging or disengaging the power cord.) This protects the park's wiring, as well as the power cord on your

vehicle from electrical damage. If electrical power fails, contact the park attendants and have them check the fuse or breaker for your supply receptacle.

---



---

## POWER CENTER (Converter)

The Power Converter is generally located on a lower cabinet face in the galley or living area of the coach.

The Converter power panel contains the house electrical system 120-volt circuit breakers and 12-volt fuses.

The Power Converter changes 120-volt AC current from the auxiliary generator or the shoreline into 12-volt DC current for use by 12-volt equipment in the motorhome.

120-Volt  
Circuit Breakers

12-Volt  
House Fuses

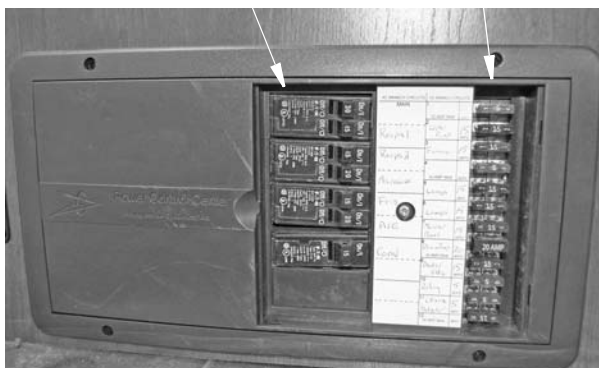

Power Center  
-Typical View

Certain circuits, however, remain unchanged for use by items which require 120-volt current, such as the air conditioner, the refrigerator in AC mode, the microwave oven, etc.

*NOTE: The Converter will not change 12-volt DC current to 120-volt AC.*

Current drawn from the house batteries passes through the Power Converter unchanged, although it is routed through a series of protective fuses located on the power panel.

## NOTICE

Do not block the converter cover vents in any way. The converter generates heat while operating and needs unrestricted airflow for proper cooling. Damage to the converter can result.

## Further Information

See the manufacturer's operation, care, and maintenance information provided in your InfoCase.

## Charging Section

The Converter charges house batteries while 120-volt external power is connected. The Converter will automatically "sense" the condition of the battery. If it is below "full charge", the Charging Section will start charging the batteries.

If the house batteries have been extremely discharged, they will accept charge at a relatively high amperage rate. If they are only slightly discharged, they will charge at a lower amperage rate. The rate of charge will decrease as the batteries reach "full charge", then will continue "trickle" charging at a very low amperage rate. If your battery does not charge as described above, it is possible the battery is defective.

## Thermal Overload

A thermal overload will "break" the 120-volt AC power to the converter section of the Power Center if the Power Converter becomes overheated. This can result from operating above its maximum limit for an extended period of time or by obstruction of ventilation to unit.

*NOTE: The Power Converter section will automatically route 12-volt lights and motors to house battery power in this event.*

The thermal overload will reset itself after a period of time, and the lights and motors will again resume operation from the Power

## SECTION 6 - ELECTRICAL

Converter section. If the breaker trips again shortly after reset, take immediate steps to correct the cause of overheating. A portion of the house 12-volt load (lights or motors or both) should be turned off to reduce total load. Also, inspect the Power Converter to ensure ventilation is not obstructed.

---

---

### CIRCUIT BREAKERS – HOUSE 120-VOLT AC

The breaker panel protects all 120-volt components in the motorhome from either an overload on the circuit or a short in the wiring or component itself. When an overload or short develops, the breaker will open preventing damage to the system.

Shut off the equipment (example: roof air conditioner) and allow a brief cooling period. Then reset the breaker by moving the switch to “Off” and back to “On”. If the breaker is continually tripped and no overload is evident, have the system checked for a short in the wiring or the appliances.

The breaker panels are located behind a door or pull-off panel on a lower cabinet face in either the galley or lounge area or beneath the rear bed, depending on model.

*NOTE: Breakers are labeled on panel.*

*Arrangement may vary according to  
appliance and equipment options.*

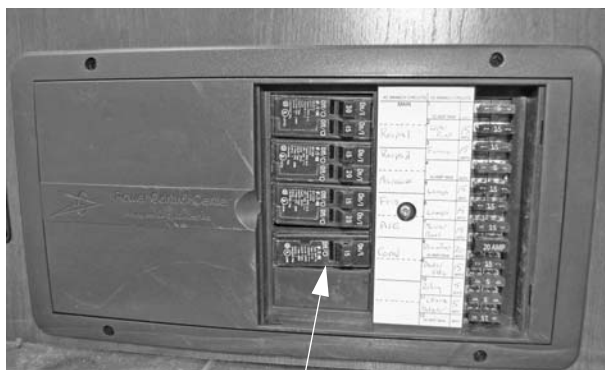

120-Volt House Circuit Breakers  
-Typical View

---

---

### ELECTRICAL OUTLETS – HOUSE 120-VOLT AC

A number of standard household electrical outlets are provided throughout the coach for connecting small appliances such as televisions, radios, toasters, etc.

An exterior outlet is also located on the outside of the coach near the entrance door or in a storage compartment on the passenger side of the coach.

---

---

### GROUND FAULT CIRCUIT INTERRUPTER

Bath, galley, and exterior outlets are connected to a GFCI (Ground Fault Circuit Interrupter), which is an extremely sensitive circuit breaker that will help to protect against severe electrical shock if a ground fault develops. If such a condition occurs, the GFCI will break the circuit by turning off the power to the protected outlets. Should this occur, unplug all the appliances on that circuit and press the reset button on the GFCI equipped outlet.

If the GFCI keeps tripping, have the electrical system checked and repaired, if necessary, before using again.

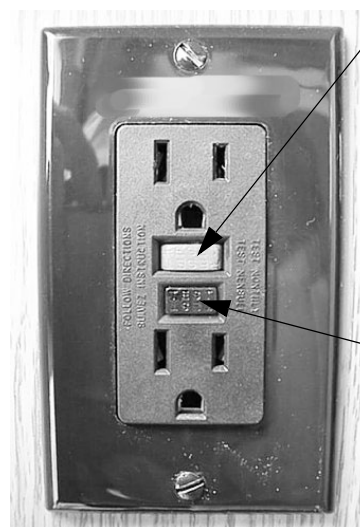

- Push to Reset circuit after monthly testing or ground fault tripping.

- Push to Test at least monthly. Should break circuit. Press Reset button to reconnect.

GFCI Outlet  
(Ground Fault Protector)

**⚠ WARNING**

The GFCI will not completely eliminate the risk of electrical shock. Infants and small children may still be affected.

**ELECTRICAL GENERATOR –  
120-VOLT  
–If Equipped**

**⚠ WARNING**

Careless handling of the generator and electrical components can be fatal. Never touch electrical leads or appliances when your hands are wet, or when standing in water or on wet ground. Do not attempt to repair the generator yourself. Service should be performed by a qualified service center.

To use the 120-volt generator, plug the power cord into the generator receptacle within the utility compartment before starting the generator.

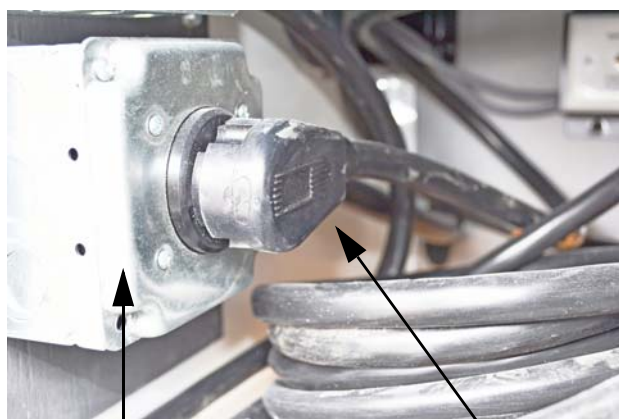

Generator Receptacle

Power Cord

**⚠ WARNING**

Do not plug the power cord into the generator receptacle while the generator is running. Electrical shock can cause personal injury.

**Generator Operation**

See the manufacturer’s operation, care and maintenance in your InfoCase.

**Generator Hourmeter**

This meter is located on the monitor panel. It registers the total number of hours that the generator has been operated.



Refer to the hourmeter to determine when periodic maintenance is due and to record services which have been performed.

**Operation Warnings and Cautions**

**⚠ WARNING**

The exhaust of all internal combustion engines contains carbon monoxide (CO). This poisonous gas is colorless, odorless, tasteless, and lighter than air. The exhaust systems of both your motorhome engine and your generator engine have been installed with your safety in mind. However, certain precautions must be taken when using them to protect yourself from conditions beyond the control of the manufacturer.

## SECTION 6 - ELECTRICAL

---

1. Do not simultaneously operate the generator and a power vent, which could draw exhaust gases into the vehicle.
2. Do not open windows or vents on the end or side of the vehicle where exhaust pipe of the generator is located.
3. Park the vehicle so that the wind will carry the exhaust away from the vehicle. Also, note the position of other vehicles to be sure their exhaust will not enter your vehicle.
4. Do not operate the generator engine while parked if vegetation, snow, buildings, vehicles, or any other object can deflect the exhaust under or into the vehicle.

*NOTE: Check auxiliary generator oil level frequently during periods of use.*

Refer to the generator manufacturer's maintenance information in your InfoCase for specific recommendations.

---

### ELECTRICAL SYSTEM – HOUSE 12-VOLT DC

The DC voltage system consists of the chassis battery, the 12-volt house batteries, and the 12-volt power converter.

#### **Converter**

See "Power Center."

#### **Chassis Battery**

The chassis battery is used to operate the engine starter and automotive accessories and controls found on the instrument panel. The electric step is also connected to the chassis battery.

See your chassis manual for further information on chassis batteries and chassis electrical system.

#### **House Batteries**

House batteries are "deep-cycle" type batteries specially designed for recreational vehicle use. They will provide longer lasting power than standard automotive starting batteries

and will withstand the frequent drain-and-recharge cycles that occur under the demanding conditions of a camping outing.

The house batteries supply power to 12-volt equipment located in the living area of the motorhome. This includes the following 12-volt powered components (if equipped): interior 12-volt lighting, range exhaust fan, propane furnace fan, fresh water pump, systems monitor panel, refrigerator, roof vent fans, slideout room systems, and 120-volt electrical generator starter.

The house batteries can also provide emergency power to start the engine if the chassis battery is discharged. (See "Battery Boost Switch" in *Section 3 - Driving Your Motorhome*).

House batteries are automatically charged by the chassis alternator while the engine is running.

---

---

### HOUSE/COACH BATTERY DISCONNECT SWITCH (COACH BATT)

The House/Coach Battery Disconnect switch lets you disconnect the house batteries from the 12-volt system of your coach during storage periods to avoid battery drain by electrical items that are hooked directly to the house batteries, such as clock displays and radio memories, etc.

Always leave this switch connected while using the coach.

*NOTE: Some electronic displays and memory functions may need to be reset after power has been reconnected.*

See also "Battery Care" elsewhere in this section.



House/Coach Battery Disconnect Switch  
(Located near entrance door)  
-Typical View

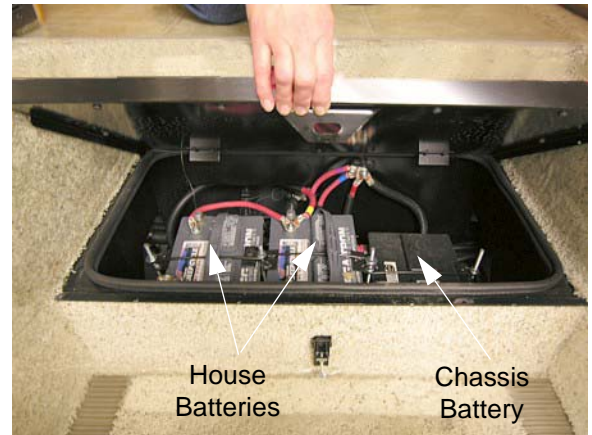

-Typical View

---

---

## BATTERY ACCESS

The house/coach batteries (and chassis batteries in certain models) are located in a compartment beneath the interior entrance steps. With the Residential Refrigerator, the house batteries will be located in a separate exterior compartment.

- Unfasten the step retainer, then lift the step upward and remove to service batteries.



- Squeeze tab upward to release latch

-Typical View



## CAUTION

Battery compartment must be closed and latched. Failure can cause injury.

---

---

## BATTERY CARE

Lead-acid type batteries are electro-chemical devices for storing and releasing electrical charge. As such, they are simply an electrical reservoir, not an electrical source. As soon as energy is removed from the battery, it should be replaced by the engine alternator or the coach converter system.

If a battery sits unused for 30 days or more, especially during warm weather, it can develop a deposit of sulfate crystals on the metal plates inside the battery. This condition is called “sulfating” and prevents the battery from either releasing or accepting a charge. If this condition occurs, the battery must be replaced.

If a battery does not contain at least 80% charge during freezing temperatures, the electrolyte can freeze and crack the battery case.



## SECTION 6 - ELECTRICAL

### The two best defenses against sulfating and insufficient charge are to:

1. Turn off the House/Coach Battery Disconnect switch to avoid parasitic discharge (the trickle discharge caused by directly connected components like propane gas detectors or digital clock displays, etc.)
2. Check the battery and recharge as necessary at least once a month during long storage periods. Turn the House/Coach Battery Disconnect switch off to avoid electrical arcing when attaching or detaching charger clamps.

### NOTICE

Disconnect batteries before connecting external charging equipment to avoid damage to sensitive electronic components.

### WARNING

This vehicle, like other vehicles, may contain small amounts of one or more substances which are listed by the state of California for causing cancer or reproductive toxicity.

### WARNING

**California Proposition 65 Warning:** Battery posts, terminals, and related accessories contain lead and lead compounds, chemicals known to the state of California to cause cancer and reproductive harm. Wash hands after handling.

*NOTE: Do not leave the shoreline plugged in during storage. Follow regular battery inspection and maintenance.*

### Further precautions are:

- Check the state of charge periodically to avoid discharge or sulfating.

To ensure that the battery will always accept and hold a charge, follow these simple maintenance practices:

- Make sure the batteries always remain securely clamped in the battery tray.
- Make sure battery cable clamps are tight on the terminal posts and are free of corrosion.
- Neutralize corrosion buildup or acid film on top of battery by washing with a baking soda/water solution. Rinse with clear water.

*NOTE: Make sure vent caps are on securely to prevent baking soda solution from entering the battery and contaminating the electrolyte fluid.*

### WARNING

Before removing any battery cables or battery, make sure all 12-volt equipment in the motorhome is off and the power cord has been disconnected. Be sure to replace the battery terminal boot, if supplied, back onto the positive terminal after servicing. Care must be taken to avoid pinching the cable between any metal parts. Should the cable be damaged, a short circuit could result in personal injury or damage to equipment. Replace any damaged cables at once. Always remove jewelry and wear protective clothing and eye covering when checking or handling batteries.

- Clean and tighten battery terminals and have the specific gravity checked at least once a year.
- Check the battery fluid level every month, or more often in hot weather. Fill to approximately 3/8 inch above the plates. DO NOT OVERFILL. If fluid is added during freezing weather, the motorhome should be driven several miles to mix water and electrolyte to prevent freezing.



- Fluid level check may be omitted if equipped with maintenance-free batteries.

 **WARNING**

To prevent wiring damage, it is essential when replacing the cables on the battery, or when using a “booster” battery, that the positive post and the positive cable be attached and the negative post and negative cable be attached. The posts are marked (+) plus and (-) minus.

If a “boost charger” is used while battery is in the motorhome, disconnect both battery cables before connecting the charger to avoid damage to engine electronic components.

Never attempt to charge or boost a frozen battery. An explosion can occur resulting in personal injury.

### Chassis Battery

If your coach is going to be unoccupied for two weeks or more, Winnebago Industries® recommends disconnecting the chassis battery in your coach to avoid battery discharge.

Disconnect the ground cable on the chassis battery (located beneath the entrance step) to disconnect battery.

---

## CIRCUIT BREAKERS AND FUSES – HOUSE 12-VOLT DC

All 12-volt circuits and equipment in the coach area of the motorhome are protected by either a fuse panel or breaker panel. When a circuit is overloaded or a short develops in any part of the system, a fuse or breaker will shut down that circuit. If this happens, turn off all affected lights or appliances and reset the breaker or replace the fuse with a new one of equal amperage rating.

### House 12-Volt Fuses

A label on the panel states the amperage rating and circuit protected for each fuse.

The fuse panel is located on the right-hand side of the Power Converter.

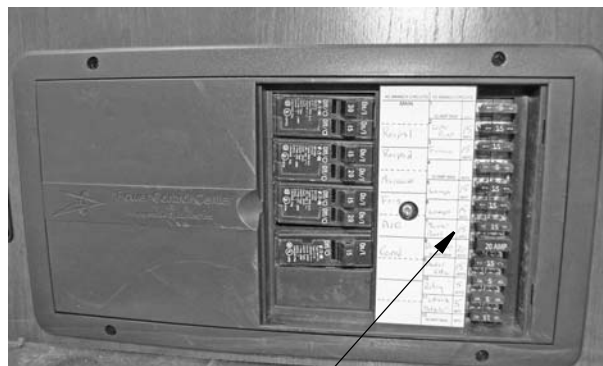

House 12-Volt Fuses  
(Located on Power Converter)  
-Typical View

The fuse panel accepts only blade type plug-in fuses. Always replace fuses with those of the same amperage rating.

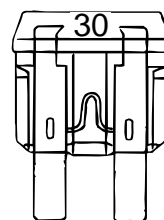

Functional

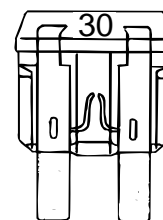

Non-Functional

### Battery Charge Meter

See related item under “Systems Monitor Panel” in *Section 4 - Appliances and Systems*.

### Battery Boost Switch

See *Section 3 - Driving Your Motorhome* for information on the Battery Boost switch.

### Automotive Chassis and House 12-Volt Circuit Breakers

A label on the Automotive Chassis and House 12-Volt Circuit Breaker panel states the amperage rating and circuit protected for each breaker.

*NOTE: Breakers are labeled on panel.*

*Arrangement may vary according to appliance and equipment options.*

## SECTION 6 - ELECTRICAL

---



Automotive Chassis and House  
12-Volt Circuit Breakers  
(Located inside passenger compartment)  
-Typical View

# SECTION 7 - PLUMBING

## FRESH WATER SYSTEM

The Fresh Water System provides water to the galley sink, shower, bathroom lavatory, toilet, and water heater. Water may be supplied by either of two sources:

- A fresh water tank and water pump located within the motorhome, or
- Any external fresh water source to which the motorhome may be connected, known as “city water”.

## Water Pressure Regulators

Because city water pressure varies from location to location, we recommend obtaining an in-line water pressure regulator to prevent damage to any components, connections, and seals in your fresh water system.

These devices simply connect in-line between the supply hose and the city water input on the coach. We recommend regulators that control water pressure to **50 psi. max.**

Water pressure regulators are commonly available at most RV dealerships and many large retail discount or home supply centers.

## Filling the Fresh Water Tank

 <b>WARNING</b>
Potable water only. Sanitize, flush, and drain water tank before using. See owner's manual for instructions, care, and maintenance information. Failure to maintain tank may result in death or serious injury.

Always fill the fresh water tank at an approved potable water filling facility or a known purified drinking water source.

The tank is filled through the City Water Connection (Fresh Water Inlet) located inside the water service center.

The Fresh Water valve routes the water from the city water hose to the fresh water tank for filling.

1. Attach hose to the Fresh Water Inlet.

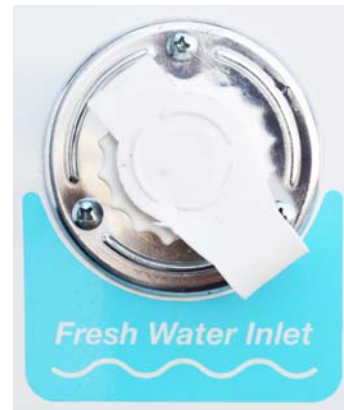

Fresh (City) Water Connection  
“Fresh Water Inlet”  
(Located in the water service center)  
-Typical View

2. Turn the Fresh Water valve to Tank Fill position.



Fresh Water Valve  
(Located in water service center)  
-Typical View

3. Turn city water supply ON.

## SECTION 7 - PLUMBING

---

4. Use the level display on the monitor panel to oversee filling of the tank, or when the tank is full, water will flow from tank vent tube beneath coach.

### NOTICE

Do not leave fresh water connection unattended when filling tank. Failure to comply may result in tank expansion and property damage.

5. Turn OFF city water supply and disconnect from the Fresh Water Inlet.
6. Turn Fresh Water valve to Normal position to use the water pump. *The Tank Fill position is only for pressure filling the water tank from the city water hose connection.*



Fresh Water Valve  
(Located in water service center)  
-Typical View

### Using City Water

When connected to an outside source of water, the water bypasses the water pump and storage tank and supplies pressure directly to individual faucets and toilet. A check valve built into the pump prevents water from entering the pump and filling the storage tank.

1. Connect hose to Fresh Water Inlet as described in previous steps.
2. With the Fresh Water valve in the Normal position, turn the Water Pump switch(es) OFF.

*NOTE: Always keep the Fresh Water valve in Normal position unless you are filling the tank. If this valve is left in the Tank Fill position while using the city water, water will keep flowing into the tank and out the tank vent tube onto the ground and the water pump will run without delivering water to faucets.*

### Disconnecting from City Water

1. Turn the city water supply OFF.
2. Open a faucet on the coach (such as the exterior wash station, if equipped) to relieve line pressure.
3. Disconnect hose from the coach and replace the cap on the Fresh Water Inlet.

*NOTE: Ensure the Fresh Water valve is in NORMAL position to use the water pump. If the valve is in Tank Fill position, the pump will run continuously without delivering water.*

---

## WATER PUMP

When your coach is not connected to a city water supply, water is supplied from the fresh water tank by a water system demand pump. A demand pump is designed to run only when you are using water. When you open a faucet, the waterline pressure drops and the pump begins to run, and it will continue to run as long as the faucet is open. When you close the faucet, the line pressure backs up to the pump, and it shuts itself off.

The pump is self-priming and will run briefly to build up line pressure when the Water Pump switch is first turned on. See “Initial Waterline Priming” for instructions on using the water system for the first time.

### Water Pump Strainer

The pump is equipped with a cleanable strainer to capture any possible tank-borne particles that could damage pump components.

*NOTE: We recommend that you check and clean the strainer after each tankful of water during the first few uses of the Water*

*Pump system. Thereafter, remember to check it at least yearly, and be sure to empty water from it during winterization procedures.*



**Water Pump Strainer**  
-Typical View

### **To Clean Pump Strainer**

- Ensure all Water Pump switches are OFF.
- Twist the inlet cap (bowl) “counter-clockwise” to unscrew from the strainer assembly.
- Remove the bowl and pull the strainer screen out of the bowl to tap out any particles and rinse clean.
- Insert the strainer screen back into the bowl, then screw the bowl back onto the strainer assembly.

*NOTE: You must also empty the strainer when winterizing your coach to avoid water freezing and cracking the filter bowl.*

### **Water Pump Switch**

The Water Pump switch is located near the monitor panel (some models may have an additional switch in the water service center, near the exterior shower, or within the bathroom area for your convenience).

While the switch is “ON”, the pump will automatically supply water as it is needed.

We recommend that you turn the Water Pump switch off whenever you will be away from the vehicle or not using the water system. In time, a

slow leak in a faucet could drain the water tank, fill the holding tank, and discharge the house batteries.

### **Initial Waterline Priming**

1. Ensure that all water drain valves are closed, including water heater valve.
2. Turn Water Pump switch to “OFF” position.
3. Fill water tank.
4. Open all faucets, hot and cold.
5. Turn ON the Water Pump switch.
6. Close each faucet as it begins to deliver a steady stream of water (close cold water first.) Leave hot water faucets on until they also deliver a steady stream of water. This will ensure that the water heater is filled with water.
7. Check to ensure the Water Pump stops soon after all faucets have been closed.
8. The Water Pump is now ready for automatic operation. The pump will start when a faucet is opened and stop when the faucet is closed.

### **Further Information**

Refer to the Water Pump manufacturer’s operation, care, and maintenance information provided in your InfoCase.

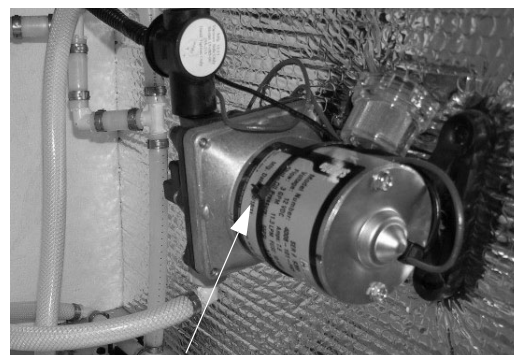

**Water Pump**  
(Located in passenger side compartment behind rear axle)  
-Typical installation shown



## SECTION 7 - PLUMBING

---

---

### DISINFECTING YOUR FRESH WATER SYSTEM

#### (As required by NFPA®1192 Standard on Recreational Vehicles)

To ensure complete disinfection of the potable water system, it is recommended that the following procedure be followed on a new system, one that has not been used for a period of time, or one that could have become contaminated.

This procedure is also recommended before long periods of storage, such as over winter.

#### Disinfecting with City Water Tank Fill

The fresh water tank must be filled through the City Water Connection (“Fresh Water Inlet”) located in the water service center.



Fresh (City) Water Connection  
“Fresh Water Inlet”  
(Located in the water service center)

This procedure requires temporarily connecting an external cartridge-type water filter assembly in-line between the city water hose and the city water fill to add disinfecting solution to the tank. These filters are commonly available at most RV supply stores.

*NOTE: If you do not have an in-line cartridge filter, see City Water Hose Disinfection following this procedure for an alternate method of adding bleach solution to your tank.*

1. Remove the filter cartridge and pour 1/2 cup of household chlorine bleach (sodium hypochlorite solution) for each 30 gallons of tank capacity into the empty filter canister, then screw the canister back onto the filter base.

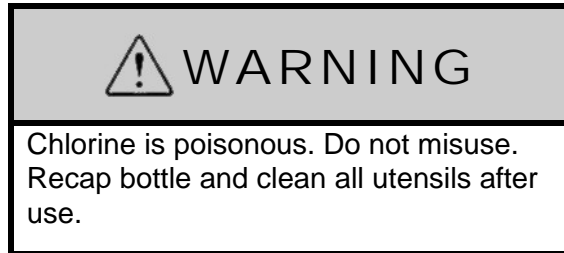

This solution will result in a residual chlorine concentration of approximately 50 ppm in the water system. *(If a 100 ppm concentration is desired as discussed in Step 3, use 1 cup of household bleach for each 30 gallons of tank capacity).*

The bleach will be drawn into the tank when the city water is turned on and the Fresh Water valve is turned to Tank Fill position.



Fresh Water Valve  
(Located in water service center)

2. Fill the tank completely, then open each faucet in the coach and run the water until a distinct odor of chlorine can be detected in the water discharged. Do not forget the hot water faucets.
3. Let the system stand at least 4 hours when disinfecting with 50 ppm residual chlorine. *(If a shorter time period is desired, then a 100*

*ppm chlorine concentration should be allowed to stand in the system for at least 1 hour).*

4. Drain the fresh water tank.
5. Install the filter cartridge into the filter canister, then refill the tank with fresh water.
6. Open each faucet again and run fresh water to flush chlorinated water from the lines. Run the water until there is no odor of chlorine detected in the water discharged. Do not forget the hot water faucets.  
*(You may need to leave a hot water faucet open for some time to flush the water heater with clean water. You may also want to turn the water heater off until this is done to avoid wasting energy trying to heat “unused” water).*
7. Water system is now disinfected.

*NOTE: An alternate way is to connect a city water hose to your coach and pour the bleach into the other end of the hose using a funnel. Hold the hose upright to avoid draining the bleach. Connect the hose to a city water hydrant to force the bleach into the tank and fill the tank with water. This method has the additional benefit of disinfecting the city water hose at the same time.*

### **Continuous Tank Disinfection (Superchlorination)**

Some RVers like to ensure continuous sanitation of their fresh water tank by “superchlorination”— maintaining an effective low level of chlorine in the tank at all times.

- Add 1 teaspoon of chlorine bleach (sodium hypochlorite) to your tank for each 10 gallons of tank capacity. When you fill the tank, this will result in a 6.7 ppm level of chlorine, which should kill harmful bacteria and slime-forming organisms.
- Chlorine may be removed from drinking water by the cold water filter at the galley faucet (if equipped) or by installing an

activated carbon water purifier at the galley sink cold waterline or a separate drinking water faucet with filter (if equipped).

- Superchlorination does not affect city water usage, only the fresh water tank.

---

---

### **SHOWER HOSE VACUUM BREAKER**

After using the shower, you may notice water dripping from the shower faucet assembly. The dripping results when vacuum in the shower hose (after closing the shower faucet) slowly releases and allows water remaining in the hose to drain down. This is a normal function of the shower valve assembly and is not a leak or defect.

If items are placed into the shower tub before shower valve vacuum release is complete, they may become wet.

---

---

### **TOILET**

The toilet in your motorhome is very similar to the household type, except that it is designed to use only a small amount of water per flush. It uses a high velocity jet of water, producing a swirl effect, to efficiently cleanse the bowl.

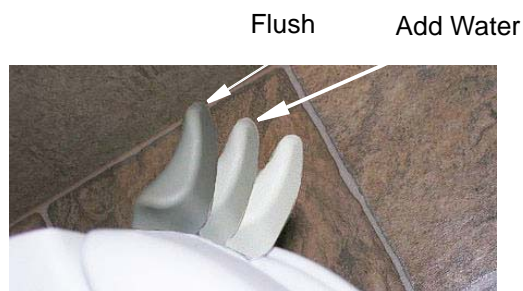

### **Important “Don’ts”**

- Don't use facial tissue or regular toilet tissue in the RV toilet. These will not disintegrate sufficiently and will often cling to the sides of the holding tank. Toilet tissue made specifically for use in RV toilets and holding tanks is available at most RV supply centers.
- Don't dispose of sanitary napkins or other non-dissolving items in the toilet.



## SECTION 7 - PLUMBING

---

- Don't put automotive antifreeze or caustic chemicals, such as laundry bleach or heavy detergents into the toilet or holding tank. These products may damage plastic or rubber parts in the system.

### Further Information

See the toilet manufacturer's operation information in your InfoCase for complete operating, care and maintenance information.

See winterizing instructions at the end of this section to prepare the toilet for storage in freezing conditions.

---

---

### DRAINAGE SYSTEM (P-TRAPS)

Ensure there is an adequate amount of water in the drainage system p-traps to avoid sewer odor from entering your coach.

If you should experience a sewer odor, pour approximately 1 cup of water down each sink and shower drain in the coach.

---

---

### WASTE WATER SYSTEM

#### (Holding Tanks)

The drainage system is self-contained and uses two separate holding tanks to contain the waste water until it can be dumped at an appropriate waste water disposal site. This means you can use the toilet, sinks, and shower even in areas where utility hookups are not available.

The black water holding tank contains the sewage from the toilet and may include bathroom lavatory on some models. The gray water holding tank contains the waste water from the galley sink and shower, and may include bathroom lavatory.

See "Specifications" in *Section 1 - Introduction* for tank capacities for your model.

#### Dumping Holding Tanks

1. Remove sewage drain hose from water service center.
2. Remove dust cap from sewage drain outlet and connect sewage drain hose. Be sure it is firmly attached.



Holding Tank Drain Valves  
(Located in water service center)  
-Typical View

***Black and Gray Waste Tank Drain Valve positions may be reversed, depending on floorplan and tank location***

***NOTE: The sewage drain outlet swivels downward (on certain models) when necessary to avoid bends in the sewage drain hose, which could trap solids while dumping, or to provide more direct drainage while using on-site sewer hook-ups.***

3. Place the outlet end of sewage drain hose into disposal opening.
4. Open the Black Waste Tank Drain Valve with a quick pull and make sure there are no sags in the hose. Move the hose gently about to dislodge any waste and ensure complete drainage. Close Black Waste Tank Drain Valve as soon as tank is empty.



- 1st - Pull Black Waste Tank Drain Valve to drain Black Water (sewage) Tank, then close.

- 2nd - Pull Gray Waste Tank Drain Valve to drain Gray Water (sink/shower) Tank, then close.

-Typical View

**NOTE: DO NOT OPEN BOTH VALVES AT ONCE.** Do not open the Gray Waste Tank Drain Valve until the black tank is drained and Black Waste Tank Drain Valve closed to avoid sewage back-up into gray tank. Gray water also rinses any black water solids from the sewage drain hose.

5. Open the Gray Waste Tank Drain Valve. Be sure there are no sags in the hose to ensure complete drainage. Close Gray Waste Tank Drain Valve as soon as tank is empty.
6. Add an odor control chemical to the sewage holding tank through the toilet. These chemicals are available at most RV supply centers.
7. Rinse sewage drain hose thoroughly with water before stowing.

**NOTE:** We recommend that you dump all holding tanks before traveling to avoid carrying unnecessary weight.

### Using On-Site Sewer Hook-Ups

The sewage drain hose may remain attached to the sewage drain outlet and be routed out the bottom of the compartment while the motorhome is parked and connected to an on-site sewage hook-up.



When using a sewer hook-up, keep the dump valves closed until a tank becomes full or when preparing to leave the site. This keeps the solids in suspension, allowing them to be carried out with the liquids when the dump valve is opened. If the valve is left open, the liquids will drain off, leaving solids in the tank. Should this accidentally happen, disconnect the hose, fill the tank about half full with water, and drive a few miles to dislodge the solids. A few starts and stops will aid in the process. Then reconnect the hose and drain in the normal manner.

**NOTE:** Always keep sewage drain outlet capped while sewage connection is not in use.

### Holding Tank Level Indicators

See “Systems Monitor Panel” in *Section 4 - Appliances* for further information on the monitor panel and checking tank levels.

See “Specifications” in *Section 1 - Introduction* for tank capacities for your model.

---



---

## WATERLINE & TANK DRAIN VALVES

The waterline and tank drain valves are used to drain water from the water tank and the water supply lines when preparing the motorhome for storage or when sanitizing the water system.

See the “Water System Drain Valve Locations” chart at the end of this section for locations on your model.

## SECTION 7 - PLUMBING

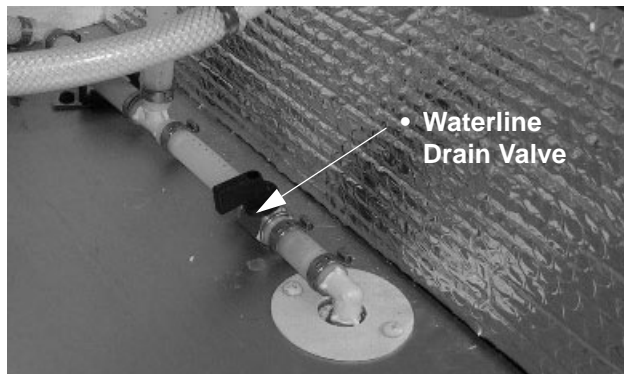
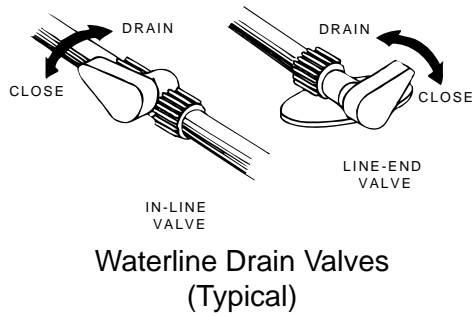

Waterline and Water Tank Drain Valves  
-Typical installation shown

(See the “Water System Drain Valve Locations” chart at the end of this section for locations on your model)

## WATER HEATER BYPASS AND ANTIFREEZE SIPHON VALVES

Your coach is equipped with a Water Heater Bypass valve and an Antifreeze Siphon (Winterization) valve for winterizing waterlines using RV antifreeze.

Turn the handle as shown to either bypass or flow mode.

Refer to the “Water System Drain Valve Locations” chart at the end of this section for locations on your model.

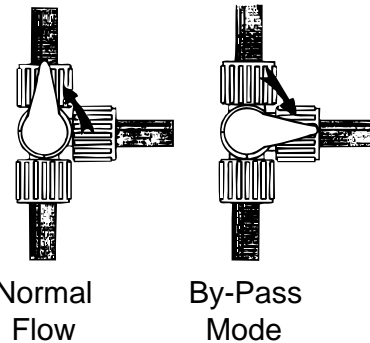

## CAUTION

Leave bypass valve handle in NORMAL FLOW position if draining water and blowing out waterlines. Place in BYPASS position ONLY when using antifreeze solution in waterlines.

## WINTERIZING PROCEDURE

You can winterize the water and plumbing system of your coach using one of the following two methods – 1) Blow out waterlines using compressed air or – 2) Fill waterlines with RV water system antifreeze.

### Method 1 – Blow Out Procedure (Drain and purge waterlines using compressed air)

1. **Level the Motorhome.** If the coach is not level, there may be “low points” in waterlines that can trap water in the lines and prevent it from draining properly.
2. **Drain Fresh Water Tank and Waterlines.** Open all waterline drain valves and drain fresh water tank (see “Water System Drain Valve Locations” chart at end of this section for locations of drain valves on your model).

3. **Open Faucets.** Turn on the water pump and open all sink faucets and shower head knobs. Leave open after water stops flowing.
4. **Drain Toilet.** Press the toilet flush lever and hold until water stops flowing in the toilet. Turn Water Pump switch OFF.
5. **Drain Water Heater.** Turn OFF the Water Heater Power switch before draining the water heater tank to avoid damage to the heating element. Drain the water heater by removing the plug from the base of the water heater tank, accessible from the outside of the coach (requires socket and ratchet).

regulated to 30 psi or less to force air through the system. A blow-out plug can be purchased at any Winnebago® or Itasca® dealer.

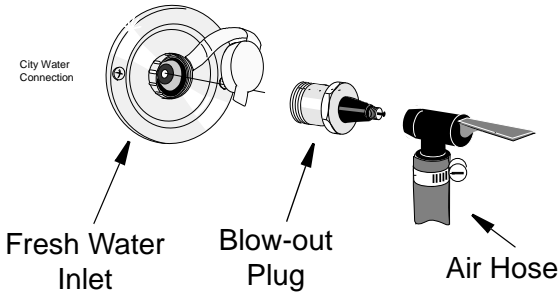

Water Heater Drain Plug  
(Remove with socket)  
-Typical View

- Also, open the Pressure-Temperature Relief valve at the top right portion of the tank to prevent air locking in the tank while draining.

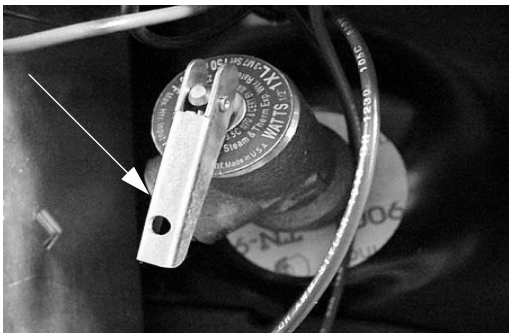

Pressure-Temperature Relief Valve  
(Lift handle only when water heater is cold)  
-Typical View

6. **Connect Air Pressure.** After water has stopped draining at all faucets and drain valves, leave faucets open and connect a “blow-out” plug to the city water connection on the coach. Then use a compressed air hose

**NOTICE**

---

Limit air pressure to 30 psi to avoid damage to equipment.

*NOTE: DO NOT burst air into the system. This can damage the water pump. It is better to let air in slowly.*

7. **Let air flow for five minutes** until water is completely drained out of faucets and drain valves, then close faucets one at a time.
8. **Drain Toilet.** Operate and hold toilet flush lever until water is completely drained from toilet.
9. **Turn air pressure off.** Disconnect water purge adapters. Recap the city water inlet to avoid contamination by dirt or insects.

**After Disconnecting Air Pressure**

10. Close all waterline and tank drain valves and all faucets to avoid contamination by dirt, insects, or rodents.
11. Reinstall the water heater drain plug and close the Pressure-Temperature Relief valve.
12. Pour about one cup of RV antifreeze down each drain for the galley sink, lavatory sink, and shower/tub. This fills the drain trap pipes to prevent holding tank odors from entering the coach during storage.

## SECTION 7 - PLUMBING

*NOTE: It is not necessary to add antifreeze to the toilet since the flush valve will be closed.*

*Do not add automotive antifreeze or caustic chemicals such as bleach or laundry detergents into the toilet bowl or holding tanks. Although these products may have a deodorizing effect, they may damage plastic and rubber parts in the system.*

13. Empty the water pump strainer filter bowl to avoid water freezing and cracking the filter bowl. See “Water Pump” previously in this section.

### Dump and Clean Holding Tanks

14. Completely drain the sewage and waste water holding tanks at an approved waste disposal site. Drain the sewage tank first so the following waste water can rinse any waste solids from the dump outlet and sewer hose.
15. Close dump valves and refit the dust cap onto the drain outlet.  
This will inhibit rust formation on valve shafts and prevent entry and contamination by airborne debris, insects, and rodents.

*Your drainage and fresh water systems are now winterized.*

*See instructions for removal from storage in Section 11 - Maintenance and Storage.*

### Method 2 – Antifreeze Fill Procedure

**(Fill plumbing lines with RV water system antifreeze)**

*NOTE: As an alternative to totally draining the plumbing system, you may winterize tanks and lines by pumping non-toxic RV antifreeze through the system.*

*This product is available from your dealer and from most RV supply stores. Follow directions on the container to determine the correct amount to use for your coach.*

Your coach is equipped with a manually operated waterline winterization system for your convenience in winterizing fresh waterlines.

The system features a Winterization (diverter) valve with an antifreeze siphon tube to draw non-toxic RV water system antifreeze into the waterlines. There is also a Water Heater Bypass valve to avoid filling the water heater with antifreeze. See the “Water System Drain Valve Locations” chart at the end of this section for location on your model.

Leave the Water Heater Bypass valve handle in NORMAL FLOW position if draining water and blowing out waterlines. Place in BYPASS position ONLY when using antifreeze in waterlines.

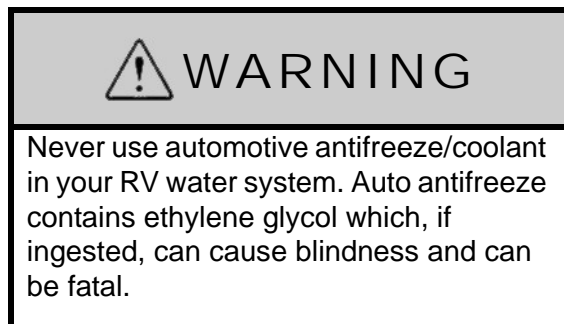

### Set Up Winterization Valves

1. Turn Water Heater Bypass valve to BYPASS position. (See “Water System Drain Valve Locations” chart at the end of this section for location of bypass valve on your model).

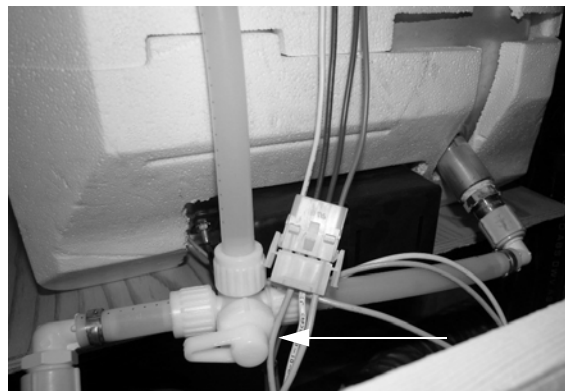

Water Heater Bypass Valve  
-Typical View

(See “Water System Drain Valve Locations” chart at the end of this section for location on your model)



2. Remove and save the protective cap from the end of the antifreeze siphon tube (save cap to cover tube after use).
3. Insert the end of the antifreeze siphon tube into a pail or other container with 2 to 3 gallons of non-toxic RV antifreeze solution.
4. Turn the Winterization valve handle so that it points toward the antifreeze siphon tube. (See “Water System Drain Valve Locations” chart at the end of this section for location on your model).

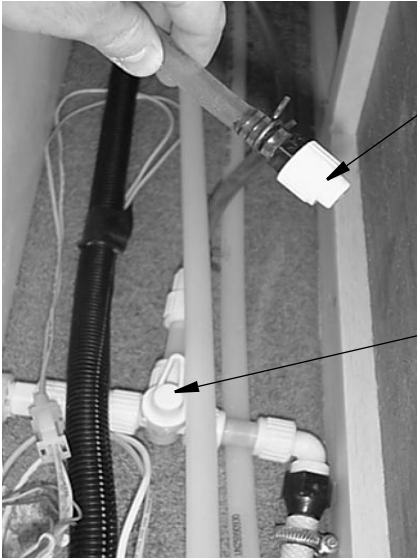

**Antifreeze Siphon Tube**

- Insert into container of RV water system antifreeze

**Winterization Valve**

- Point toward antifreeze siphon tube to winterize

**RV Antifreeze Siphon Tube  
and Winterization Valve  
-Typical View**

(See “Water System Drain Valve Locations” chart at the end of this section for location on your model)

*NOTE: Ensure that all drain valves are CLOSED before pumping RV antifreeze into the water system. Refer to the “Water System Drain Valve Locations” chart at the end of this section for valve locations on your model.*

**Fill Lines**

5. Turn the Water Pump switch ON.
6. Open each hot and cold water faucet handle in the coach - one at a time, until antifreeze solution just begins to flow from the faucet, then close.

7. Press the toilet flush lever and hold until antifreeze begins flowing into the toilet. Leave small amount of antifreeze that remains in the bowl.

**When Done Adding RV Antifreeze**

8. Turn the Water Pump switch OFF.
9. Turn the Winterization valve so it points toward the waterline to the water pump. This will stop the flow from the antifreeze siphon tube and revert the tank line flow to the water pump.
10. Replace the protective cap onto the end of the antifreeze siphon tube to keep out insects and debris when not in use.

**Drain Water Heater**

11. Turn OFF the Water Heater power switch before draining the water heater tank to avoid damage to the heating element.
12. Drain the water heater by removing the plug from the base of the water heater tank, accessible from the outside of the coach (requires socket and ratchet).



**Water Heater Drain Plug  
(Remove with socket)  
-Typical View**

- Also, open the Pressure-Temperature Relief valve at the top right portion of the tank to prevent air locking in the tank while draining.

## SECTION 7 - PLUMBING

---

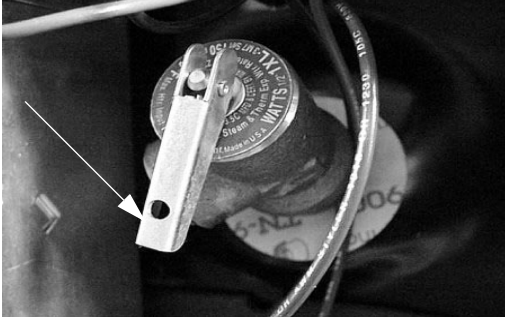

Pressure-Temperature Relief Valve  
(Lift handle only when water heater is cold)  
-Typical View

13. Reinstall the water heater drain plug and close the P-T Relief valve when drained.

### **Fill Drainage System P-Traps**

14. Pour about one cup of RV antifreeze down each drain for the galley sink, lavatory sink, and shower/tub. This fills the drain trap pipes to prevent holding tank odors from entering the coach during storage.

### **Dump and Clean Holding Tanks**

15. Completely drain the sewage and waste water holding tanks at an approved waste disposal site. Drain the sewage tank first so the following waste water can rinse any waste solids from the dump outlet and sewage drain hose.
16. Close dump valves and refit the dust cap onto the drain outlet. This will inhibit rust formation on valve shafts and prevent entry and contamination by airborne debris, insects, and rodents.

*Your drainage and fresh water systems are now winterized.*

*See instructions for removal from storage in Section 11 - Maintenance and Storage.*



WATER SYSTEM DRAIN VALVE LOCATIONS		
Model	System	Drain Valve Locations
<b>Model 26HE</b>	<b>Waterlines</b>	<ul style="list-style-type: none"> <li>Two (2) in-line drain valves located behind the service panel in the water service center and one (1) valve located in passenger side compartment behind rear axle).</li> </ul> <p><i>Also, place the tip of your finger inside the city water connection and gently press the backflow valve (small “button” in center of connector) to drain any water left in the city waterline.</i></p>
	<b>Water Tank</b>	<ul style="list-style-type: none"> <li>Drain valve in passenger side compartment behind rear axle.</li> </ul>
	<b>Water Heater</b>	<ul style="list-style-type: none"> <li>Drain plug on outside of coach behind service door. Use socket to remove drain plug.</li> </ul>
	<b>Water Heater Bypass Valve</b>	<ul style="list-style-type: none"> <li>One (1) valve inside galley cabinet. Open door under galley sink to access.</li> </ul>
	<b>Winterization (Antifreeze) Valve</b>	<ul style="list-style-type: none"> <li>One (1) valve and siphon tube located in passenger side compartment behind rear axle.</li> </ul>
<b>Model 31KE</b>	<b>Waterlines</b>	<ul style="list-style-type: none"> <li>One (1) drain valve below the service panel in water service center.</li> </ul>
	<b>Water Tank</b>	<ul style="list-style-type: none"> <li>Drain valve in passenger side compartment behind rear axle.</li> </ul>
	<b>Water Heater</b>	<ul style="list-style-type: none"> <li>Drain plug on outside of coach behind service door. Use socket to remove drain plug.</li> </ul>
	<b>Water Heater Bypass Valve</b>	<ul style="list-style-type: none"> <li>One (1) valve inside galley cabinet. Open door under galley sink to access.</li> </ul>
	<b>Winterization (Antifreeze) Valve</b>	<ul style="list-style-type: none"> <li>One (1) valve and siphon tube located in driver side compartment forward of rear axle.</li> </ul>



# SECTION 8 - ENTERTAINMENT

## FRONT TV IGNITION SWITCH INTERLOCK

### -If Equipped

If your coach is equipped with a front overhead TV, it is plugged into a special electrical outlet with a built-in ignition switch interlock. The device allows the front overhead TV to operate only when the ignition key is in the Off or Accessory positions.



Front TV Ignition Switch Interlock  
-Typical View

## TV ANTENNA - DIGITAL (Jack® Digital HDTV Over-the-Air Antenna)

Your coach is featured with a digital antenna, which provides crystal clear digital HD reception of over-the-air channels in addition to superior broad reception range.

The digital antenna is equipped with a built-in amplifier for maximum VHF and UHF programming.

 **WARNING**

Never allow the antenna to touch electrical power lines or any other electrical wires.

## Operating the Digital Antenna

1. Turn the Digital Antenna Power Switch ON.

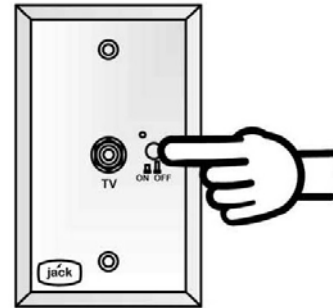

Digital Antenna Power Switch  
(Located in an overhead cabinet or mounted on a wall near the TV)

2. Turn ON the Signal Meter Power switch (located on the side of the Signal Meter).



Digital Antenna Signal Meter  
(Located on ceiling)

3. Rotate the Attenuator Dial fully CLOCKWISE.
4. Press Release Button on the Rotational Knob and rotate antenna (until maximum number of LED lights illuminate on the Signal Meter).

## SECTION 8 - ENTERTAINMENT

---

*NOTE: LED lights will illuminate from left to right. All LED lights may not illuminate, depending on signal strength.*

5. Rotate Attenuator Dial COUNTER-CLOCKWISE until the last illuminated LED light flickers.
6. Rotate antenna to illuminate the last flickering LED light.
7. Repeat Steps 5 and 6 to pinpoint signal reception.

*NOTE: Refer to television manufacturer's instructions to scan for available channels.*

### Further Information

See the antenna manufacturer's user guide provided in your InfoCase for complete operating and maintenance information.

---

---

### TV SIGNAL AMPLIFIER

The TV Signal Amplifier is built into the antenna and can be turned on or off with a power switch located on a switchplate near the entertainment center cabinet.

An indicator light will illuminate when the switch is on and the signal amplifier is active.

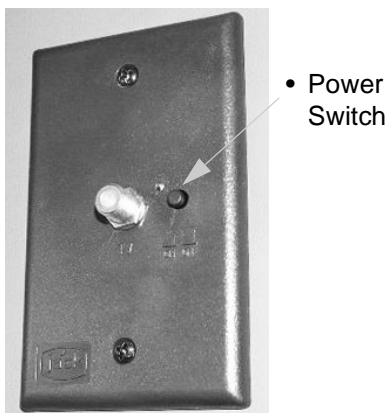

TV Signal Amplifier Power Switch  
(Located in an overhead cabinet or mounted on a wall near the TV)  
-Typical View

---

---

### CABLE TV CONNECTION

Your coach is equipped with a cable television input connection (located in the water service center) for your convenience.

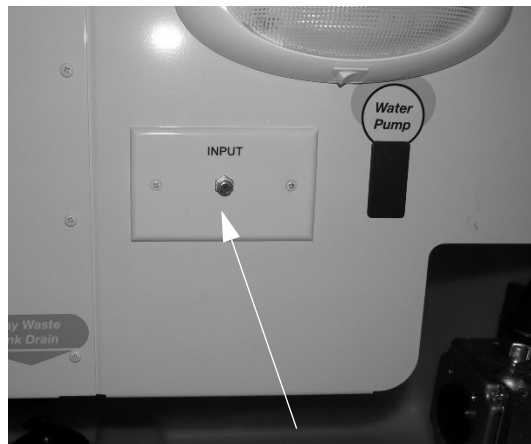

Cable TV Connection  
(Located in water service center)  
-Typical installation shown

## SECTION 9 - FURNITURE AND SOFTGOODS

### LOUNGE CHAIR - SWIVEL

**-If Equipped  
(Typical View – Your coach may differ in appearance)**

This chair is not equipped with a seat belt and is not intended for seating while the vehicle is in motion.

When the vehicle is in motion, the base of the Lounge Chair must be fastened to the floor using the provided base clamp, as shown.



 **WARNING**

The chair must be clamped back into place before driving the coach.



Lounge Chair Base Clamp  
(Travel position shown)  
-Typical View

When the vehicle is parked, you may unscrew the knob and remove the base clamp to position the chair away from the wall.

### SLEEPING FACILITIES

 **WARNING**

Sleeping facilities are not intended for use while vehicle is in motion. For safety, passengers must use safety belted seating positions while vehicle is in motion.

### DINETTE/BED CONVERSION

**-If Equipped  
(Typical View – Your coach may differ in appearance)**

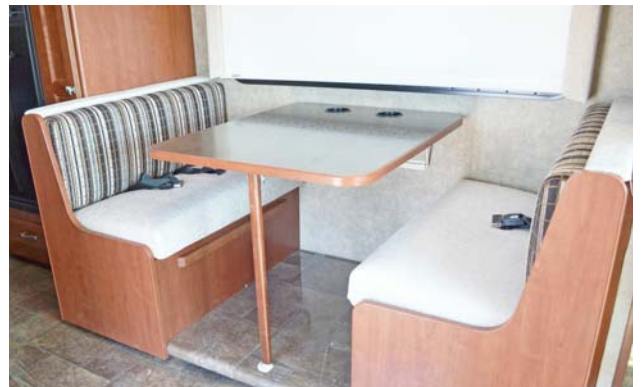

#### Dinette to Bed

1. Remove both dinette back cushions and set aside.

## SECTION 9 - FURNITURE AND SOFTGOODS

---



2. Lift both dinette seat cushions upward.



5. Remove the table from the wall support bracket by lifting the end of the table.



3. Release the table leg from the floor support bracket.

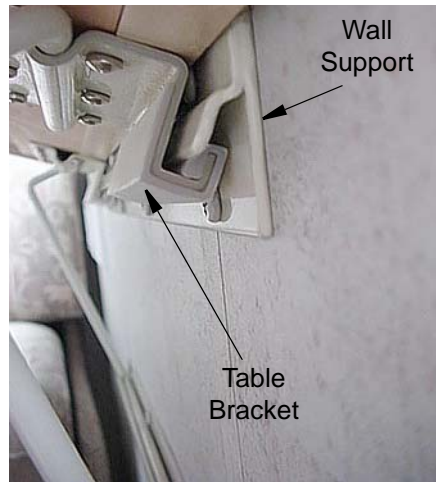

6. Then lower the table to rest on the cleats attached to each dinette bench.



4. Release the catch on the table leg brace and fold the leg up against the bottom of the table.



7. Arrange dinette cushions to cover bed area.

*NOTE: Additional bolsters may be included with your dinette to cover bed area.*





### Bed to Dinette

Reverse steps to convert back into dinette seating.

Once the table is reattached onto the wall support, make sure the table leg is secured into the floor support bracket and the leg brace is locked.



---

---

## U-SHAPED DINETTE/BED CONVERSION

### -If Equipped (Typical View – Your coach may differ in appearance)

The U-Shaped Dinette can be converted into additional sleeping space when needed by lowering the dinette table and arranging the dinette cushions.

1. Get a partner to help you lift the table top upward off the support tubes and set the table top edgewise onto the floor to remove the table leg tubes.



2. Pull the table leg tubes from the floor or table sockets and store beneath dinette seat.
3. Place the table top onto the ledge of the dinette seat.

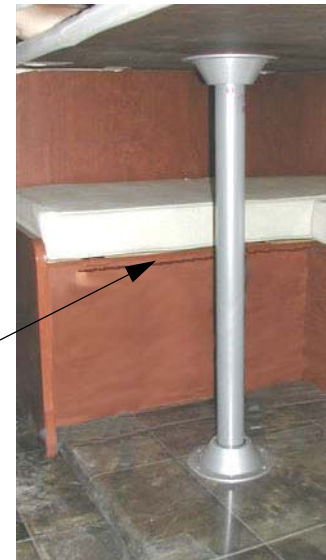

4. Place the center back dinette cushion into place over the table to complete the bed conversion.

Reverse steps to reassemble to dinette configuration.

---

---

## SOFA/BED CONVERSION



## SECTION 9 - FURNITURE AND SOFTGOODS

**-If Equipped  
(Typical View – Your coach may differ in  
appearance)**

### **Sofa to Bed**

- Press **DOWN** on security latch handle (accessible through front sofa opening) to release sofa seat.

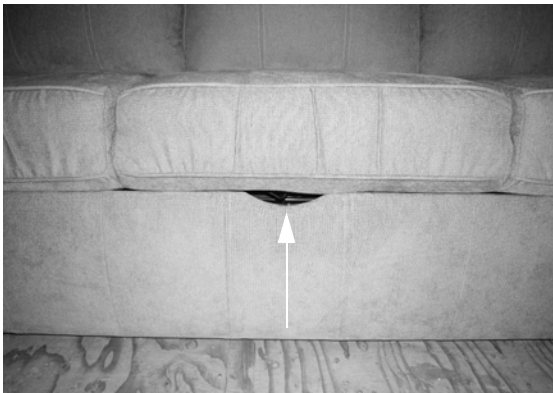

Security Latch Handle accessible through front sofa opening



Security Latch Handle  
(Shown with sofa seat lifted)  
- Press **DOWN** to release

- Lift the front edge of the sofa seat upward and pull outward from the wall while gently pushing downward on the backrest until the cushions lie flat.
- The bed is now ready for use.

### **Bed to Sofa**

- Push the front edge of the sofa seat toward the wall while lifting upward on the backrest until the sofa is fully seated against the wall and security latch “clicks” into locked position.

---

---

### **BUNK – FRONT PULL DOWN**

**-If Equipped  
(Typical View – Your coach may differ in  
appearance)**

The Front Bunk is stowed near the cab ceiling as shown in the following photo.



### **To lower bunk for use**

1. Push **UP** on bunk release lever to disengage the Bunk Storage Latches (one located on each side of the bunk) and lower.

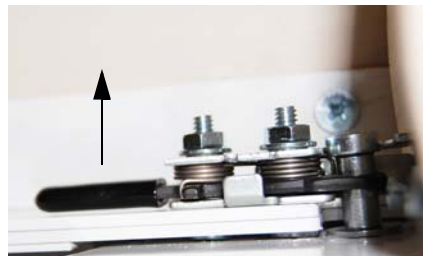

Bunk Storage Latches  
(Located on each side of bunk)  
-Typical View

2. Grasp the top of bunk and pull down.



3. Grasp the mattress and bunk board pull down.

4. The bed is now ready for use.



*NOTE: This low bunk design may be accessed without the use of a ladder. If needed, a multi-purpose step stool may be used.*

- Maximum Capacity: 300 lbs.
- To avoid injury to young children, do not leave them unattended on the bunk.

### **Stowing the bunk**

Reverse previous steps to store bunk, ensuring Bunk Storage Latches are engaged. Ensure cables are not binding when bunk is folded.

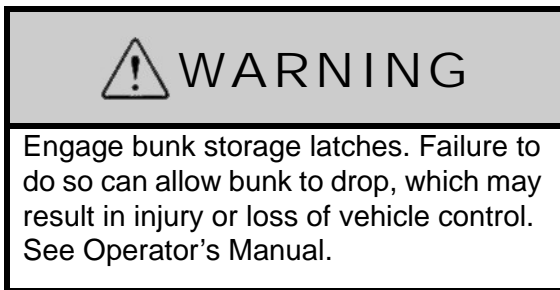

---

---

## **ROLLER SHADES**

Your coach is featured with Roller Shades that can be used for light filtering, daytime room darkening, or nighttime privacy.

Lower Roller Shade by grasping the bottom center of the shade and pulling straight down by hand.

Raise Roller Shade by grasping the bottom center of the shade and pulling straight down and allowing the shade to retract into stored position.



-Typical View

---

---

## **WOOD FURNITURE AND CABINETRY**

### **-If Equipped**

People are drawn to the natural beauty of wood. At Winnebago Industries®, our craftsmen work with the art found in each piece of wood to create cabinets of superior quality, backed by the Winnebago Industries warranty.

- Oak is a strong, open-grained hardwood that ranges in color from white to pink and reddish tones. Streaks of green, yellow, and even black may appear due to mineral deposits. Oak may also contain wormholes and wild, varying grain patterns. This distinct graining is considered a desirable quality and has made oak one of the most popular woods used for cabinetry.
- Maple is a close-grained hardwood that is predominately white to creamy-white in color, with occasional reddish-brown tones. While maple typically features uniform graining as compared to other wood species, characteristic markings may include fine brown lines, wavy or curly graining, bird's eye dots and mineral streaks. These traits are natural and serve to enhance maple's natural beauty.
- Cherry is characterized by its red undertones, but may vary in color from white to a deep, rich brown. Cherry is a close-grained wood with fairly uniform texture, revealing pin knots and curly graining. All wood will age

## **SECTION 9 - FURNITURE AND SOFTGOODS**

---

with time and the finish will darken. This is especially true for cherry. This is a sought-after quality in cherry cabinetry, and those who select it expect this evolution.

No matter which species you choose for your new Winnebago Industries motorhome cabinetry, please keep in mind that no two pieces of wood are exactly the same.

Stains are likely to exaggerate the difference between open and closed grains and other markings in wood. Grain variation and color change should be expected. As hardwood ages, it will darken when exposed to different types of light. Color differences or changes in wood can also be caused by exposure to harsh chemicals, extreme heat, or other contributing external conditions.

Any color change that occurs in both the finish and the wood is considered part of the natural aging process and is not to be considered defect or damage.

Additionally, wood species exhibit other defining characteristics, such as mineral deposits/streaks, knots, sap runs, pin holes, and wormholes. These markings make the wood unique and contribute to its enduring beauty.

Therefore, since wood is a product of nature and will have certain natural characteristics and variances, they are not covered under the warranty.

# SECTION 10 - SLIDEOUT ROOMS AND LEVELING

## SLIDEOUT ROOM KEYLOCK

A Master Slideout Room Keylock is located near the interior slideout control switch(es). This keylock must be turned ON to operate slideout room(s).



Master Slideout Room Keylock  
(Located near interior slideout control switches)



Slideout Control Switch  
-Typical View



**CAUTION**

Never drive the vehicle with a slideout room extended!

The slideout room system uses 12-volt DC motorized mechanisms with an electronic control system to provide smooth operation and positive weather seal.

## SLIDEOUT ROOM OPERATION – ELECTRIC



**WARNING**

Your motorhome may have more than one slideout room. Understand which switch operates which slideout room prior to operation. Make sure all slideout rooms are clear of people who could be harmed or obstacles that could cause damage prior to operating any slideout rooms. Failure to observe can result in death or serious injury.

Slideout rooms provide a spacious living area at the push of a button.

The Slideout Control switch is typically located near the Systems Monitor Panel or on a wall near the slideout room.



**WARNING**

**CRUSH HAZARD.** Keep people and objects clear of the inside and outside of the slideout room when operating. Failure to comply could result in death or serious injury.

## To Extend Slideout Room

### Before Extending!

- Level the coach and set the Parking Brake.
- Ensure exterior compartment doors are closed so that they will not interfere with slideout operation.
- Check inside and outside the vehicle to make sure that there are no people who could be harmed or obstacles that could cause damage due to room extension.

## SECTION 10 - SLIDEOUT ROOMS AND LEVELING

---

- If the slideout room has a couch or other furniture, make sure no people or pets are seated on them until the room has been fully extended.

### Extend Procedure:

See *“Before Extending!”* before proceeding.

- Insert the safety lock key into Slideout Room Master Keylock and turn to activate the Slideout Control switch.
- Press and Hold the Slideout Control switch in the OUT position until the room is fully extended, then release.
- To stop extending the room during operation, release the Slideout Control switch.
- Deactivate the Slideout Control switch with the Slideout Room Master Keylock.

### To Retract Slideout Room

#### Before Retracting!

- Be sure the coach is level and the Parking Brake is set.
- Ensure exterior compartment doors are closed so that they will not interfere with slideout operation.
- Check inside and outside the vehicle to make sure that there are no people who could be harmed or obstacles that could cause damage due to room retraction.
- Stow all furniture extensions before retracting slideout rooms to avoid property damage.
- If the slideout room has a couch or other furniture, make sure no people or pets are seated on them until the room has been fully retracted.
- Remove all items from the coach living room floor and close cabinet doors and drawers. Be sure there are no items at the end of the bed, behind the driver seat, or protruding from compartments, which could be crushed or cause damage to floor covering or cabinets when the room is retracted.

## NOTICE

Because the slideout roof is drawn into the interior of the coach when retracted, be sure there is no debris, such as excessive dirt, tree seeds, twigs, leaves, etc. on the roof before retracting.

### Retract Procedure:

See *“Before Retracting!”* before proceeding.

- Insert the safety lock key into Slideout Room Master Keylock and turn to activate the Slideout Room Control switch.
- Press and Hold the Slideout Control switch in the IN position until the room is fully retracted, then release.
- To stop retracting the room during operation, release the Slideout Control switch.
- After the room is retracted, deactivate the Slideout Control switch with the Slideout Room Master Keylock.

---

## SLIDEOUT ROOM – EXTREME WEATHER PRECAUTION

Certain extreme weather conditions, such as heavy rains, heavy snow, and high winds, or any combination of these, could cause damage to the slideout room cover-awning (if equipped) or reduce effectiveness of the slideout room weather seals.



Slideout Cover-Awning  
-Typical View



Also, freezing rain and snow can prevent the slideout cover-awning (if equipped) from closing and may cause damage to the cover-awning, slideout room, weather seals, and mechanisms.

To avoid potential damage, we recommend retracting your slideout room during extreme weather conditions.

---

### SLIDEOUT ROOM TROUBLESHOOTING (LIPPERT)

#### -If Equipped

#### Battery Voltage or Circuit Breaker Problems

##### If the slideout room will not work:

- Turn the House/Coach Battery Disconnect switch OFF and then ON again. This will, in many cases, reset power to the slideout system.
- The house battery may be low on charge. Plug in the external power cord (shoreline), start the engine, or start up the generator (if equipped). This may assist slideout room operation.
- The chassis battery may be low on charge. Press and Hold the Battery Boost switch (located on the dash) while pressing the interior slideout control switch. This momentarily connects the house batteries to assist in slideout room operation.
- The circuit breaker may be tripped. The circuit breaker, labeled “Slideout Power” is located on a panel on an interior wall of the passenger side storage compartment just behind or ahead of the entrance door.

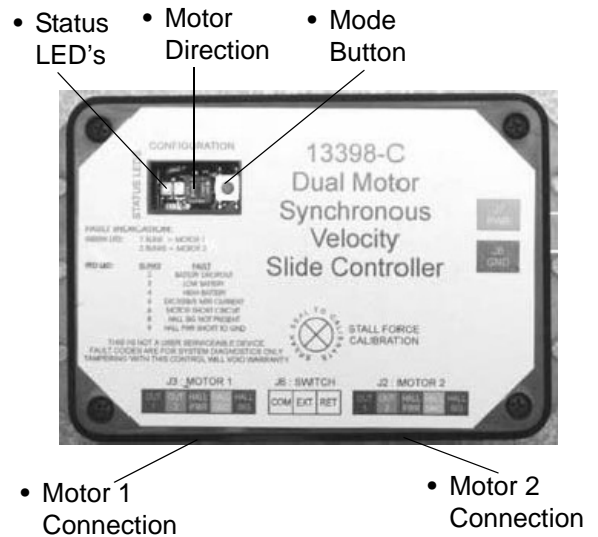

Slideout Room Controller  
(Located in a driver or passenger side compartment, depending on model)  
- Remove panel to access

#### Error Codes

When an error occurs during slideout room operation, the slideout control panel (located in passenger side compartment) will use LED display lights to indicate where the problem exists.

For specific motor faults, the green LED light will blink 1 time for Motor 1 and 2 times for Motor 2. The red LED light will blink from 2 to 9 times, depending on the error code. The error codes are as follows:

- **(2) - BATTERY DROP OUT.** Battery capacity low enough to drop below 6 volts while running.
- **(3) - LOW BATTERY.** Voltage below 8 volts at start of cycle.
- **(4) - HIGH BATTERY.** Voltage greater than 18 volts.
- **(5) - EXCESSIVE MOTOR CURRENT.** High amperage (also indicated by one side of slideout room continually stalling).
- **(6) - MOTOR SHORT CIRCUIT.** Motor or wiring to motor has shorted out.



## SECTION 10 - SLIDEOUT ROOMS AND LEVELING

---

- **(8) - HALL SIGNAL NOT PRESENT.** Encoder is not providing a signal. This is usually a wiring problem.
- **(9) - HALL POWER SHORT TO GROUND.** Power to encoder has been shorted to ground. This is usually a wiring problem.

*NOTE: When an error code is present, the slideout control panel needs to be reset. Operating the Extend/Retract switch will reset the slideout control panel. Operate the Extend/Retract switch again for normal operation.*

### Manual Override

**In the event that the slideout room fails to retract and manual operation is required:**

- Locate the slideout control panel (located in passenger side compartment).
- Press the Mode button 6 times, quickly. Press a 7th time and hold for approximately 5 seconds.  
*Red and green LED lights will begin to flash, confirming the override mode.*
- Release Mode button.
- Use the slideout control switch (located inside the coach) to retract the room.

*NOTE: If slideout room fails to retract using the Manual Override method, see "Slideout Emergency Retraction" elsewhere in this section.*

### Further Information

See the slideout room operating guide included in your InfoCase for further instructions and troubleshooting information.

---

---

## SLIDEOUT EMERGENCY RETRACTION (LIPPERT)

### -If Equipped

If the slideout mechanism is malfunctioning and the room will not retract using the interior control switch or exterior control panel, you may need to access the slideout motors and manually push the room in to the travel position.

There are two slideout motors equipped on the end wall of each slideout room. Pull back wipe seal to access motors.

### Push-In Procedure

1. Remove slideout motor retention screw (located along exterior slideout trim), if equipped.

**Repeat on opposite slideout trim.**

*NOTE: If your coach is not equipped with slideout motor retention screws, proceed to Step 2.*

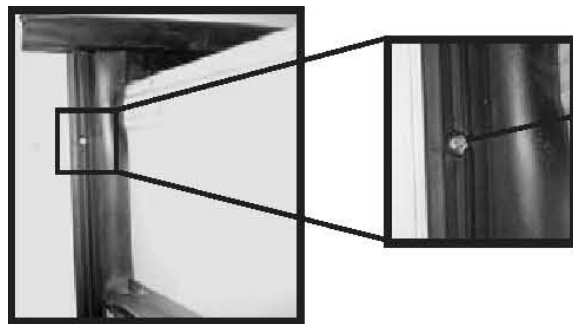

Slideout Motor Retention Screw  
(Located along exterior slideout trim)  
-If Equipped

2. Pull back wipe seal to access slideout motor.
3. Using a flat-head screwdriver, push bottom of slideout motor UP to disengage (approximately 1/2" from base).

**Repeat on opposite slideout motor.**

## SECTION 10 - SLIDEOUT ROOMS AND LEVELING



**Slideout Motor**  
(Located behind slideout wipe seal)

- Use a screwdriver to push slideout motor UP (disengage).

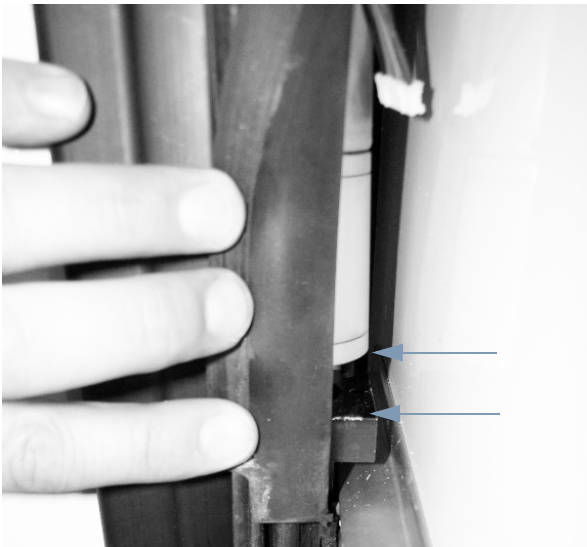

- Ensure slideout motor is disengaged approximately 1/2" from base.

4. Push slideout room in to travel position, ensuring both sides are relatively even.

*NOTE: Several people may be needed to push the room in.*

5. When the slideout room is fully retracted, secure the room with a support item (e.g. 2x4 wood board) above the interior slideout room to secure room during travel.

*NOTE: For larger slideout rooms, place a travel support item on each end of the interior slideout room.*



**Slideout Travel Support**  
-Typical installation shown

- Place support item (e.g. 2x4 wood board) above interior slideout room as shown.

6. See your dealer for service of the slideout motors before using again.

### Further Information

Please refer to the slideout manufacturer's user guide provided in your InfoCase for further instructions and troubleshooting information.

---

---

### GENERAL SLIDEOUT CARE

- Keep slideout room seals clean.
- Clean the floors inside the coach before retracting the slideout room to avoid floor scratches or carpet pile snags.
- Wipe outer slideout room seals occasionally with talc or 303 brand protectant for smooth, quiet operation.
- See your authorized dealer for regular maintenance and service of the slideout mechanism.

## SECTION 10 - SLIDEOUT ROOMS AND LEVELING

### Slideout Room Seal Care and Maintenance

While most household cleaners work well for cleaning slideout room seals, certain chemical agents may cause the seals to degrade. Typically, 409® and Lysol® type products work well. Use a product, such as Armor All® to keep seals soft.

In addition, certain caulks and sealers may include chemicals that may adversely effect the performance of the seals. See your authorized dealer for caulks and sealers recommended for your coach.

*while in PARK, raising either one or both of the rear wheels off the ground could allow the vehicle to roll off the jacks.*



### LEVELING SYSTEM

The Hydraulic Leveling System makes selecting a parking site easier and faster by reducing the effect of uneven ground.

Hydraulic jacks raise the affected low corners of the coach to make leveling “set up” faster and easier for you.

The Hydraulic Leveling System Control Panel is located on the dash.



Leveling System Control Panel  
(Located on dash)

See the **Leveling System Operation Guide** provided in your **InfoCase** for complete **operating instructions**. It also contains additional precautions, technical information, and instructions for manual operation if a system failure occurs.

*NOTE: When parking at an uneven site, always park the front of the vehicle to the downhill side. This allows you to level by raising the front end rather than the rear. Since only the rear wheels are locked*

### WARNING

- Keep all people clear of the coach while the leveling system is operating.
- When extending the rear stabilizers, do not lift the wheels beyond ground contact. This makes it possible for the vehicle to roll unexpectedly forward (or backward) off the jacks. This could cause severe injury or death.
- Do not use the levelers on icy or slick surfaces on which the foot pads may slip.
- Do not use leveling jacks to support the vehicle for service or tire changing.
- Do not use the leveler as an emergency brake. They are not designed for any type of vehicle braking purpose.
- Never check for hydraulic fluid leaks using your hands and/or any other body part. The leaking fluid is under pressure and is capable of cutting and penetrating your skin, resulting in severe injury.

### Jacks Down Light

The “Jacks Down” reminder is intended to warn you to retract your Leveling Jacks before moving the vehicle. The light will come on

briefly and a chime will sound when the ignition key is turned to the On or Run positions if the jacks are down.



“Jacks Down” Light  
(Located on dash)  
-Typical View

### NOTICE

- Do not try to drive vehicle unless “TRAVEL” light is glowing with ignition switch on.
- Do not try to drive the vehicle until the air suspension system has built up sufficient pressure if you have used the coach leveling system or have used the DUMP button to manually exhaust the air suspension system.
- Do not rely only upon the warning lights to indicate when jacks are up. It is the owner’s responsibility to check that all jacks are up before moving the coach.

*NOTE: If the Leveling Jacks should fail to retract, see “Troubleshooting” and emergency operation instructions in the Leveling System Operation Guide provided in your InfoCase.*

### In The Event Of Accidental Jack Extension

1. Bring the vehicle to a safe and complete stop as soon as possible.

2. Turn the Leveling System Power switch ON, use the arrow “Down” button and select “Auto Retract”, and press Enter.
3. Visually inspect the vehicle undercarriage for any problems.
4. See the Leveling System Operation Guide supplied in your InfoCase for troubleshooting instructions or operating the Leveling System if jacks fail to retract or any other functions fail.

### Further Information

See the manufacturer’s operation guide provided in your InfoCase for complete operating instructions, safety precautions, and troubleshooting tips.

---

---

### CHECKING HYDRAULIC OIL LEVEL

See the Leveling System Operation Guide provided in your InfoCase for complete maintenance instructions and information.

All maintenance should be done as part of the normal servicing of the coach.

The hydraulic oil level should be checked when the vehicle is first purchased and after any extended storage. During regular vehicle use the hydraulic fluid level should be checked once a month. If an oil leak develops, the hydraulic oil level needs to be checked frequently until repairs can be completed.

The hydraulic pump/reservoir is located behind the driver side front tire. In certain models, an access panel must be removed to access the pump/reservoir.

*NOTE: Leveling jacks must be in the retracted (UP) position to get an accurate oil level.*

The hydraulic oil level is checked visually by inspecting the hydraulic oil reservoir. Always keep the hydraulic oil level full (to the lip of the breather cap).

*NOTE: Always clean away any dirt and debris from the top of the reservoir before removing the breather cap to avoid entry*

## SECTION 10 - SLIDEOUT ROOMS AND LEVELING

---

*of debris and contamination of hydraulic oil in the reservoir, which could lead to pump failure or other problems.*

Breather/Fill Cap

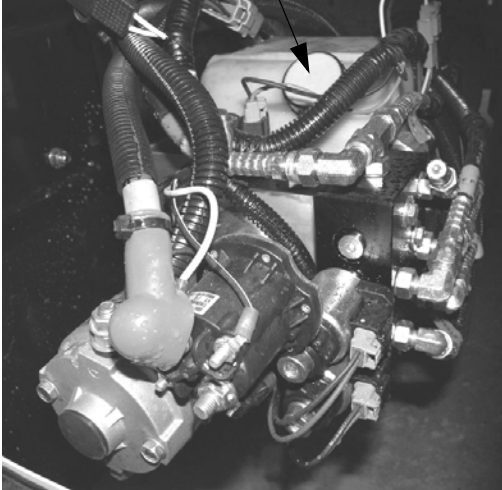

Hydraulic Oil Reservoir  
(Located behind driver side front tire)  
-Typical View

*NOTE: Only fill the hydraulic reservoir with the jacks in the retracted (UP) position. Adding fluid with the jacks in any other position will cause fluid to leak through the breather/fill cap.*

### **Hydraulic Fluid Recommendation**

The leveling system is filled from the factory with AW-22S synthetic hydraulic oil that has been specially formulated for use in the leveling system and that is compatible with Automatic Transmission Fluid (ATF).

DO NOT USE brake fluid or hydraulic jack oil, which can damage the seals and cause leaks.

### **Further Information**

For replacement fluids, see the manufacturer's recommendation in the leveling system operation manual provided in your InfoCase.

# SECTION 11 - MAINTENANCE AND STORAGE

---

---

---

## SEALANTS – INSPECTION AND GENERAL INFORMATION

Water is a recreational vehicle's worst enemy when it is allowed to enter where it is not intended. Sealants perform a very important function and should be inspected closely and maintained regularly. Winnebago Industries® utilizes many different types of sealants. Refer to the "Sealants Call-Out Sheet" provided in your InfoCase for further information.

Sealants, in general, do not have "set" lifetimes. Varying environmental factors affect the pliability and adhesiveness of sealants. You or your dealer must:

- Inspect all sealants, a minimum of every six months.
- Inspect the moldings, windows, clearance lights, exterior compartment doors, and all their attachments.
- Also, inspect weather seals around entrance door, etc., and if necessary, have a dealer replace them immediately.
- Check for cracks, voids, gaps, breaks, adhesion, and any sign of physical deterioration.

*NOTE: Proper sealant inspection includes not just visual observation but running a finger along sealant seams to verify proper adhesion to the surface. Any loosened areas must be replaced.*

- Have the sealant replaced if you notice any of the above. Your local Winnebago Industries dealer has the correct and necessary parts and experience to help you maintain your sealants. See "Sealants Call-Out Sheet" provided in your InfoCase.
- Always use the same type sealant that was removed.
- Immediately have dealership check moldings, windows, and exterior attachments for leak source if you notice water inside of unit.

### NOTICE

Sealants must be inspected every 6 months and replaced if necessary.

---

---

## ROOF

### WARNING

STAY OFF ROOF. Surface may be slippery. Falling could result in death or serious injury.

The roof is made of Thermo-Panel materials like the walls and floor. It will support the weight of an average adult for periodic maintenance or repair of the roof or roof mounted components.

Walking or working on the roof should be left to qualified service personnel using proper safety equipment in a safe environment. You should only walk or work on the roof if you are qualified and have created a safe environment.

For your safety, it is not recommended that you store or carry items on the roof.

Always have damage to the roof area repaired immediately. Damaged or detached sealant around the vents, air conditioner, body-to-roof seams, etc., should also receive immediate attention. Delaying these repairs may allow water leakage and result in damage to interior ceiling and body panels, upholstery, etc., which is not covered by the limited warranty (see "New Vehicle Limited Warranty" provided at the beginning of this manual).

---

---

## UNDERCARRIAGE

Buildup of mud and dirt under the body of the vehicle can cause damaging rust or corrosion on steel or aluminum parts and can add needless



## SECTION 11 - MAINTENANCE AND STORAGE

---

weight to the vehicle. This, in effect, reduces the amount of cargo you can carry and remain within GVWR and GAWR limits.

Corrosive materials, such as those used for ice and snow removal and dust control, can also accumulate on the underside of a vehicle. These materials should be removed by flushing the undercarriage regularly with water, especially horizontal surfaces, cavities, and other areas where mud and other deposits may collect.

---

---

### EXTERIOR FINISH

The exterior surface of your motorhome has an automotive gel-coated fiberglass finish.

Follow these precautions to keep it looking its best and preserve maximum gloss and durability.

#### Parking

- Avoid parking under trees. Rinse bird droppings and tree sap off as soon as possible. Lukewarm soapy water can help speed up the cleaning process.
- Avoid parking near ocean salt spray.
- Avoid parking near factories with heavy smoke or industrial fallout.

#### Driving

- Gravel roads should be avoided.
- Antifreeze, fuel, or window solution spilled on plastic surfaces, decals, and appliques should be rinsed off immediately with water.
- Bugs and bird droppings should be rinsed off with water or washed with lukewarm soapy water daily.

#### Washing

- Frequent washing and thorough cleaning is recommended to prevent damage to the finish from exposure to damaging salts, calcium chloride, road tar, tree sap, insects, and other foreign material.
- Do not use strong soaps or detergents for washing the motorhome.

- Wash with cool water out of direct sunlight using a mild liquid soap (any “no-tears” baby shampoo can be used). Never wash the vehicle in direct sunlight or while the vehicle surface is hot.
- Be careful when using pressure-type washers to avoid loosening exterior decals or sealants.

*NOTE: Avoid aiming water flow from a hose or spray from high-pressure washing equipment into any appliance intake because damage or difficulty in operating appliances may occur.*

- Commercial vehicle wash facilities should be avoided. Revolving brushes, “soaking” solutions, and high-pressure water spray may damage sealants, decals, and appliques.
- Pressure-sensitive appliques or decals on your coach require very little maintenance, but should be treated like any painted surface on your vehicle. Wash with mild soap and water and rinse thoroughly. See “Exterior Graphic Care” for details.
- After washing the coach, carefully inspect sealant around window frames and vents and any other joints that may have loosened or separated. See “Sealants - Inspection and General Information” at the beginning of this section for details.

### NOTICE

Never use a strong solvent such as lacquer thinner, or harsh abrasives on plastics, decals, and painted surfaces.

#### Waxing and Polishing

When water will not bead up and roll off the finish of your freshly washed vehicle, a coat of automotive wax may be applied to the finish. Wax not only improves the appearance of the vehicle, but protects the finish against oxidation and corrosive substances.

We recommend using a wax that is compatible with painted and gel-coated fiberglass finishes.

If the finish begins to look dull or discolored, it may need to be cleaned with a polishing or cleaning compound formulated for gel-coated fiberglass finishes.

*NOTE: If you use a polish or a cleaning compound that does not contain a wax preservative, we recommend reapplying a coat of hard wax after cleaning or polishing the finish.*

### **Inspection**

A motorhome exterior is subjected to many physical forces and environmental conditions. While the coach is parked, it is exposed to climate and weather extremes and other environmental conditions. While in operation, it is subjected to various twisting and flexing forces caused by routine cornering and turning, and by uneven road surfaces, such as bumps, potholes, railroad tracks, and parking lot entrances.

Inspect the exterior fiberglass shell periodically for cracks, which may represent a threat to the integrity of the fiberglass.

Minute cracks in the surface, commonly called "spider cracks" or "hairline cracks" caused by normal flexing of the fiberglass exterior are normal and typically pose no threat to the integrity of the vehicle other than appearance.

However, if a crack has opened up and the weave of the cloth is visible, this does represent a threat to the integrity of the fiberglass and must be repaired or covered as quickly as possible to avoid penetration by moisture, especially in freezing climates.

If the fiberglass has been damaged and contains cracks, tears or holes, use plastic sheeting and duct tape, if necessary, to prevent moisture from damaging the sidewall material or the interior of the coach.

---

---

### **EXTERIOR GRAPHIC CARE**

The pressure-sensitive graphics on your vehicle require very little maintenance. In order to allow the graphics to have the longest life possible, the following steps should be taken.

- Wash graphics with plain soap and water or any car wash detergent. Rinse thoroughly.
- High pressure water spray may loosen or damage graphics. Keep spray nozzle at least 1 1/2 feet from the edge of the graphics.
- Test any cleaning solution on a small section of graphic before using.
- Never use aromatic solvents such as acetone, M.E.K., toluene, paint thinner or lacquer thinner on graphics. Solvents may soften the vinyl and smear colors.
- Gasoline or other fuels spilled on graphics should be rinsed off immediately with water.
- Do not apply paint or clearcoat over the graphics.
- Do not apply wax over the graphics, especially wax containing petroleum distillates. Wax that has dried along the edge of a graphic can be removed with cotton swabs after softening it with isopropyl alcohol. Rinse area thoroughly after cleaning.

---

---

### **PLASTIC PARTS - CLEANING**

Many parts in your vehicle, such as the dash, exterior light lenses, and certain exterior body panels are made of high-impact plastic materials that can be damaged by wiping with solvents or improper cleaning products.

Always try cleaning plastic parts with the mildest cleaners first and work your way up to stronger cleaning products. Use the following cautionary lists as a guide when selecting cleaning products to use on plastic parts.

<h2><b>NOTICE</b></h2>
------------------------

<p>Do not use citrus-based cleaners on polycarbonate finishes. Citric compounds will damage the high-gloss surface, causing it to appear dull or "flat". Always test a cleaning product on a hidden area to be sure it will not cause damage to the appearance of the part.</p>
---

## SECTION 11 - MAINTENANCE AND STORAGE

---

Here is a list of mild cleaners that **may be used safely**:

- Car washing soap and water
- Glass cleaners *without ammonia*
- Mineral oil
- Multipurpose cleaners (such as Fantastik<sup>®</sup>, Formula 409<sup>®</sup>, etc.)

The following products, compounds, or solvents must be **wiped off immediately** to avoid damage:

- Ammonia
- Brake fluid
- Bathroom basin, tub, and tile cleaners
- Chlorine
- Ethyl alcohol
- Isopropyl (rubbing) alcohol
- Kerosene or gasoline
- Naphthalene
- Pine-type household cleaners

**Do not use** cleaners containing the following products, compounds, or solvents. These products **will damage** the finish.

- Acetic acid
- Acetone (nail polish remover)
- Aromatic solvents (lacquer thinners)
- Benzene
- Butyl alcohol

---

---

### EXTERIOR LIGHTS

Most Winnebago Industries<sup>®</sup> vehicles have polycarbonate lenses on exterior lamps, which are very sensitive to a variety of chemical solvents and cleaners.

Use only soap and water to clean exterior lamp lenses, especially headlights.

- Contact with certain chemicals can cause etching, “crazing” or cracking of the lens, which can significantly reduce the lens clarity and effectiveness of the lamp and may require replacement of the complete lamp housing.

- Some popular citric acid cleaners may cause polycarbonate lenses to become “hazy” or “foggy”.
- Do not use a pressure washer to clean headlights.
- Inspect and operate the lights regularly to confirm proper operation and mounting condition.

---

---

### INTERIOR SOFT GOODS

We recommend a weekly routine of vacuuming all fabrics and carpet throughout the motorhome to prevent an accumulation of dirt, which can detract from the appearance and shorten the life of carpet and fabrics.

#### Fabric Upholstery

Some fabrics used in this motorhome may contain fire retardant and lightfastness additives, which can be damaged by use of improper cleaning products. Some water-based household cleaning products are not formulated for use on fabrics and may cause excessive shrinkage or fading. Always test any cleaning product on a hidden area of fabric before using on visible areas. For best results, fabric cleaning should be referred to a professional carpet and upholstery cleaner.

*NOTE: To minimize fading of upholstery, carpets and other interior fabrics caused by excessive sunlight, the drapes, blinds, or shades should be closed when the motorhome is parked for an extended period of time.*

 **WARNING**

When cleaning upholstery and fabric, do not use lacquer thinner, nail polish remover, laundry soaps, or bleach. Never use carbon tetrachloride, gasoline, or naphthalene for any cleaning purpose. These materials may cause damage to the material being cleaned and most are highly flammable, posing risk of injury due to fire.

**Leatherette**  
**-If Equipped**

Most common stains can easily be cleaned with a solution of 10% household liquid dish soap and warm water, applied with a soft damp cloth. Thoroughly rinse all solution with clean water. Never use harsh chemicals as it will break down the finish.

**Vinyl Fabrics (including ceiling)**  
**-If Equipped**

Vinyl should be cleaned with a soft, damp cloth, and a mild detergent only. Do not use solvents. Solvents may damage the surface of the vinyl.

**Draperies, Curtains, and  
Bedspreads**

These items may be woven from a variety of fabrics. We recommend that these be professionally dry cleaned only. A five percent shrinkage may occur when you have these items dry cleaned.

**General Stains**

As with any stain or contamination, the quick response is the best, especially when done in conjunction with the proper cleaner for the type of stain.

## SECTION 11 - MAINTENANCE AND STORAGE

### CEILING FABRIC CARE

#### -If Equipped

While using your coach, your ceiling fabric may become soiled and require spot cleaning from time to time.

These materials are made from polypropylene or polyester synthetic fibers, so they clean very well with virtually no damage to the color or fabric itself.

Most commercially available carpet and upholstery cleaners will do an excellent job removing stains. From time to time, additional cleaning methods may need to be used to remove stubborn or difficult stains.

The following cleaning chart is provided as a guideline for care and cleaning of ceiling fabrics used in your coach.

CEILING FABRIC STAIN REMOVAL		
Type of Stain	Cleaning Agent	How to Remove
Mustard	Dry-Clean Solvent	Scrub-Soak-Blot Dry
Ketchup*	High Strength Detergent	Scrub-Soak-Blot Dry
Coffee*	High Strength Detergent	Scrub-Soak-Blot Dry
Chocolate*	Detergent	Scrub-Soak-Blot Dry
Tea	High Strength Detergent	Scrub-Soak-Blot Dry
Chewing Gum	Dry-Clean Solvent	Scrub-Soak-Blot Dry
Oil	High Strength Detergent	Scrub-Soak-Blot Dry
Grease	High Strength Detergent/Degreaser	Scrub-Soak-Blot Dry
Tar/Asphalt	K-1 Kerosene/Thinner	Scrub-Soak-Blot Dry
Wax	Detergent	Hot Iron on Detergent-Soaked Towel/Cloth
Rust	Rust Remover	Scrub-Soak-Blot Dry
Dirt*	Detergent	Scrub-Soak-Blot Dry
Lipstick	Dry-Clean Solvent	Soak-Blot Dry
Nail Polish	Dry-Clean Solvent	Soak-Blot Dry
Shoe Polish	Dry-Clean Solvent	Soak-Blot Dry
Crayon	High Strength Detergent	Scrub-Soak-Blot Dry
Marker (indelible)	Detergent	Scrub-Soak-Blot Dry
Ink (Ballpoint Pen)	Dry-Clean Solvent	Soak-Blot Dry
Pencil Lead (Graphite)	Detergent	Scrub-Rinse-Blot Dry
Vomit*	High Strength Detergent	Scrub-Rinse-Blot Dry-Deodorize w/Vinegar
Urine*	High Strength Detergent	Scrub-Rinse-Blot Dry-Deodorize w/Vinegar
Blood*	High Strength Detergent	Scrub-Rinse-Blot Dry
Excrement*	High Strength Detergent	Scrub-Rinse-Blot Dry-Deodorize w/Vinegar

*NOTE: In many cases listed above, repeated steps may be required to fully extract contaminant from material. Items listed above with (\*) may also be removed through steam extraction method by a professional cleaner or service. Always check to see that the cleaner used will not cause damage to the material or fabric by testing on an area out of sight.*

#### Water Stains

Water stains should be cleaned with a mixture of 1/4 cup of white powdered or clear liquid laundry detergent (no coloring) in a bucket of warm water. Working with a clean sponge or white cloth, start from the outside of the stain and work your way to the center. This method will keep the stain from spreading. Do not over saturate as this may cause delamination. No need to scrub, simply rub lightly or dab the stain.

You may have to repeat this procedure more than once to achieve desired results. Finish up with clean water, using the same method, and blot dry.

Steam cleaning is also an option. Again, take care not to over-saturate the material.

---

---

## **CABINETRY – CLEANING**

Wooden items may be cleaned with a soft cloth and a good quality wood finish cleaning product.

Vinyl simulated wood panels may be cleaned with a mild, water-based cleaner and a soft cloth. Do not use solvents on vinyl wood panels.

*NOTE: Many cabinetry and furniture items throughout this motorhome are constructed either partially or completely of real hardwoods. Because of natural variations in woodgrain density, slight differences in stain hue may exist between one item and another. This is the distinctive character and beauty of real wood.*

---

---

## **TABLES AND COUNTERTOPS**

Work surfaces are covered with a plastic or thermo-formed laminate that resists solvents, stains, and abrasions. A coat of furniture wax applied to these surfaces on the counters and table will help preserve their beauty and make cleaning easier. Always clean the surface before applying wax.

---

---

## **GALLEY SINK**

### **Acrylic**

### **Care and Cleaning Instructions**

The galley sink has been designed and engineered to resist scratches and should not stain under normal household use if used properly.

To keep this product looking its best, we recommend that you take a few easy precautions.

### **General Cleaning**

Clean often with hot water and soap. If a cleanser is necessary, make sure the product is recommended for use on plastics.

Avoid harsh abrasive cleaners, ammonia, or citric-based products as discoloration may result.

Rinse all food, beverage, or cosmetic residue from the sink as soon as possible. Some residues, if left to sit in the sink, may require the use of detergent or a mild liquid or gel-type kitchen surface cleaner.

If acids or medicine spill on the surface, wash the spills immediately.

### **Hard-to-Remove Food and Beverage Residue**

For most stubborn stains, fill the sink about one quarter full with a 50/50 solution of bleach and water. After 10 or 15 minutes of soaking, drain solution from the sink as you rinse both sides and bottom.

*NOTE: Do not use steel wool or metal scouring pads.*

### **Marks or Discoloration**

A color-matched automotive scratch remover compound may be used to remove stubborn marks or discoloration. Always follow label directions.

*NOTE: Improper use may damage this product and void the warranty.*

---

---

## **RANGE AND REFRIGERATOR**

For care and appearance maintenance of the range and refrigerator, refer to the appliance manufacturer's operation and maintenance manuals included in your InfoCase.

---

---

## **VINYL FLOORING**

### **Care and Maintenance**

You can easily maintain the beauty of your vinyl flooring with little effort, by following these recommendations:



## SECTION 11 - MAINTENANCE AND STORAGE

---

- Sweep or vacuum floor daily (use a vacuum without a beater bar head.) Remove loose dirt with a soft brush or Swiffer® type product.
- For more intense cleaning, use a non-abrasive cleanser, such as Mr. Clean®. Rinse with clean water.

*NOTE: Floor cleaners containing waxes, brighteners, or gloss agents are not recommended.*

- Regular cleaning with solvent-based chemicals may adversely affect the topcoat performance.
- Do not use undiluted bleach or leave a dilution of bleach on the floor for longer than one hour.
- Vinyl flooring is extremely durable and long lasting. It is normal for the floor to show some denting and dimpling where furniture sets due to the soft nature of the material. The dents are not permanent and will come out over time.

### Maintenance Tips

- Install protection (such as pads or casters) on furniture with legs or sharp edges. This protection should not contain bitumen, which may cause brown stains.

*NOTE: Faulty pads and casters should be removed and replaced.*

- Burning cigarettes and matches can cause damage to the flooring.
- Use doormats (that do not contain bitumen) to keep out most of the dirt and dust.
- Remove spills immediately with a damp cloth, followed by rinsing with clean water.
- The use of stiletto heels is not recommended, as they may cause permanent damage to the flooring.
- Protect flooring from prolonged direct sunlight exposure.

### Treatment of Stains

**Acids, alkali, alcoholic beverages, coffee, soft drinks, ketchup, fruit, fruit juices, food, vegetables, mustard, ink, and iodine:**

- Remove the stain with lukewarm water and a cloth or sponge. If necessary, clean with a soft nylon pad and non-abrasive mild detergent or resilient floor cleaner.

#### Heel marks:

- Clean as soon as possible with a soft nylon pad and non-abrasive mild detergent or resilient floor cleaner.

**Asphalt, candle grease, chewing gum, fat, oil, tar, and shoe polish:**

- Gently remove with a blunt instrument and treat with a soft nylon pad and non-abrasive floor cleaner.

#### Lacquer and nail polish:

- Remove as soon as possible. Do not allow to dry. If necessary, apply nail polish thinner (sparingly) to remove any residue.

#### Corrosion, paint, and grass stains:

- Treat as soon as possible with a soft nylon pad and non-abrasive mild detergent or resilient floor cleaner.

#### Varnish, oil paint, and solvents:

- Blot up as soon as possible. Do not rub, as this will only spread material further across the surface. Carefully treat with a mild cleanser. When dry, carefully peel the stain off. MEK may be used sparingly, if necessary. Rinse immediately with clean water.

#### Pet stains:

- Treat with lukewarm water. If stain remains visible, clean with a soft nylon pad and non-abrasive resilient floor cleaner.

---

---

## BATHROOM

### Toilet

For instructions on the care of your toilet, refer to the information in your InfoCase.

## **Tub and Shower Walls**

The tub and shower walls in the bathroom should be cleaned with mild soap and warm water. Do not use an abrasive cleaner on the shower walls and tub, as scratching and discoloration may occur. Stubborn stains may be removed with an automotive-type cleanser.

## **Lavatory Sink**

The lavatory sink is made of the same material as the galley sink. See Galley Sink - Care and Cleaning Instructions.

---

---

## **DOORS AND WINDOWS**

Windows may be periodically cleaned with a good quality glass cleaner or mild soap solution using a soft cloth.

Use care when removing ice or frost from the windows. Always use a plastic ice scraper, never one made of metal. Use care when removing ice from the mirrors to protect the reflective surfaces.

Door locks and hinges should be lubricated periodically with powdered graphite to ensure trouble-free operation and to protect against freeze-up.

---

---

## **VEHICLE STORAGE – PREPARATION**

Properly preparing your vehicle for storage will lessen the possibility of damage to your vehicle. Prepare the motorhome for vacancy just as you would if you were leaving your house for an extended period.

### **Clean and Prep Coach for Storage**

1. Turn off the propane gas tank.
2. Turn the Electronic Thermostat switch OFF.
3. **Remove all foods and items that may cause odors from cabinets and refrigerator.**
4. Clean and defrost the refrigerator. Prop the door open slightly to allow any odors to dissipate. Place an open box of baking soda inside the refrigerator to help absorb odors.

5. **Fully charge the batteries. Batteries must have at least 80% charge to survive freezing temperatures and long period of non-use.** We recommend that you connect a battery charger or plug in the shoreline once a month during long-term storage periods to maintain battery charge and to avoid sulfating. If connecting a charger directly to batteries, turn the House/Coach Battery Disconnect switch off to avoid electrical arcing when attaching and detaching charge clamps.

*NOTE: We do not recommend leaving the shoreline plugged in continuously during storage.*

6. After charging batteries, turn the House/Coach Battery Disconnect switch off and disconnect the ground cable on the chassis battery to avoid parasitic\* drain.  
  
*\* Parasitic battery drain is the gradual drain by items connected directly to battery power such as clocks, radio memory, and the engine computer.*
7. Have the vehicle chassis completely serviced and lubricated. Be sure radiator antifreeze protection level is sufficient for the lowest anticipated temperatures.
8. Wash and wax the coach.
9. Inspect all seams and seals around doors, windows, vents, and any other joints. Replace or repair any that are damaged. Sealing materials and compounds can be purchased from your dealer. Badly damaged weather seals may need to be replaced by your dealer.
10. Close all windows and roof vents. Protect all appliance vent openings from contamination by animals or insects (e.g. bird nest, wasp nests, etc.)
11. Lubricate all door hinges and locks.
12. Clean the interior of the coach. Dirt and stains are more easily removed when fresh.

If you are storing your vehicle through the winter, or in cold climates, extra preparations must be made to protect equipment and systems

## SECTION 11 - MAINTENANCE AND STORAGE

---

that can be damaged by freezing temperatures. See “Winterizing Procedures” in *Section 7 - Plumbing*.

---

---

### VEHICLE STORAGE – REMOVAL

1. Completely air out the motorhome.
2. Have the entire LP gas system checked for leaks.
3. Check window operation.
4. Check cabinet and door hinges. Lubricate with penetrating oil, if necessary.
5. Close all faucets and drain valves that are open.
6. Add a few gallons of water to the fresh water tank and turn on the water pump to check for leaks, especially at fittings.
7. Open all faucets in turn to release trapped air and check to be sure faucet washers have not hardened during storage.
8. Sanitize the water system as outlined under “Disinfecting the Fresh Water System” in *Section 7 - Plumbing*, then flush the waterlines thoroughly with fresh water.
9. Check the toilet for proper operation.
10. Add water to the holding tank using the toilet flush lever and galley sink faucet. Ensure dump valves seal tightly.
11. Check around all appliances for obstructions and ensure that all vent openings are clear.
12. Start refrigerator and check for proper cooling.
13. Clean wall and counter surfaces.
14. Replace batteries, if necessary, and check out electrical system to make sure all lights and electrical components operate.
15. Check tires for proper cold inflation pressure. See “Vehicle Certification Label” in *Section 1 - Introduction*.
16. After washing accumulated winter grime from the vehicle, it is important to carefully inspect the seams and sealants for separation or cracks that may have appeared around the window frames, vents, and any other joints. See *Sealants – Inspection and General*

*Information* at the beginning of this section. Re-sealing is quite simple and the material is quickly and easily applied. Appropriate compounds are available from your dealer. See “Sealants – Recommended Application” page in the Supplement Manual provided in your InfoCase.

Also inspect weather seals around doors, etc., and if necessary, have a dealer replace immediately.

---

---

### CHASSIS SERVICE AND MAINTENANCE

Consult the appropriate sections in your chassis manual for specific information regarding operating safety, service recommendations, and maintenance schedules for the chassis section of your vehicle.

## SECTION 11 - MAINTENANCE AND STORAGE

### COACH MAINTENANCE CHART

These recommendations apply for normal recreational use. Heavy duty or full-time use may require more frequent maintenance intervals.

Always use specified sections or manufacturer's guide for further information and instructions.	Before Each Use	Weekly	Monthly	Every 3 Months	Every 6 Months	Every Year	As Necessary
<b>Propane Gas System</b>							
Have propane gas system checked for leaks						◆	◆
Pressure Regulator - inspect and adjust if needed						◆	
Check propane tank condition, mounting, and fittings						◆	
<b>Electrical System</b>							
Check Battery Condition Meter	◆						
Check battery fluid level and connections			◆				
Check 12V fuses and 120V breakers							◆
Check GFCI receptacles			◆				
<b>Generator</b>							
Visually inspect generator and compartment	◆						
See generator manufacturer's maintenance guide							◆
<b>Plumbing System</b>							
Sanitize plumbing system							◆
Winterize plumbing system							◆
Clean water pump strainer filter						◆	◆
<b>Slideout &amp; Leveling System</b>							
Check and adjust							◆
Check hydraulic oil level			◆				◆
Check hydraulic lines (routing, leaks, etc.)						◆	
Inspect slideout room seals (bulb seals), clean as necessary				◆			
Check and inspect electric slideout lock drain line(s)							◆
<b>Exterior</b>							
Clean roof				◆			◆
Clean sidewalls			◆				◆
Clean windows							◆
Flush underside of vehicle				◆			◆

# SECTION 11 - MAINTENANCE AND STORAGE

## COACH MAINTENANCE CHART

These recommendations apply for normal recreational use. Heavy duty or full-time use may require more frequent maintenance intervals.

Always use specified sections or manufacturer's guide for further information and instructions.	Before Each Use	Weekly	Monthly	Every 3 Months	Every 6 Months	Every Year	As Necessary
<b>Safety Equipment</b>							
Check operation of the following items:							
Headlights, Taillights, and Marker Lights	◆		◆				
Turn Signals	◆		◆				
Horn	◆		◆				
Hazard Warning Flashers	◆		◆				
Windshield Wipers and Washers	◆		◆				
Fire Extinguisher - check charge indicator	◆		◆				
Smoke Alarm - test operation *	◆		◆				
Carbon Monoxide Alarm - test operation *	◆		◆				
Propane Gas Leak Detector - test operation	◆		◆				
(*replace battery if needed)							
<b>Appliances</b>							
<b>Water Heater</b>							
See water heater manufacturer's maintenance guide							◆
Inspect and clean exterior vent	◆						◆
<b>Refrigerator</b>							
See refrigerator manufacturer's maintenance guide							◆
Inspect and clean exterior vent/drip tray drain tube	◆						◆
<b>Furnace</b>							
See furnace manufacturer's maintenance guide							◆
Inspect and clean exterior vent	◆						◆
<b>Air Conditioner</b>							
See A/C manufacturer's maintenance guide							◆
Inspect for exterior damage				◆			◆
Check/replace filter			◆				
<b>Range Top</b>							
See range manufacturer's maintenance guide							◆
Inspect and clean/replace range hood grease filter							◆

## SECTION 11 - MAINTENANCE AND STORAGE

### COACH MAINTENANCE CHART

These recommendations apply for normal recreational use. Heavy duty or full-time use may require more frequent maintenance intervals.

Always use specified sections or manufacturer's guide for further information and instructions.	Before Each Use	Weekly	Monthly	Every 3 Months	Every 6 Months	Every Year	As Necessary
<b>Sealants</b>							
Inspect (see "Sealants - Inspection and General Information" at the beginning of this section for proper inspection technique)					◆		◆
Replace (see "Sealant Call-out Sheet" in the supplement manual provided in your InfoCase)							◆
<b>Frame &amp; Chassis</b>							
Follow chassis manufacturer's maintenance guide (refer to chassis manual)							◆
Inspect hitch receiver (if towing)	◆						
<b>Tires</b>							
Check and adjust air pressure	◆						◆
Check tread wear	◆						◆
Check front end alignment and adjust if needed							◆
<b>Miscellaneous</b>							
Lubricate locks, hinges, and latches						◆	◆





## SECTION 12 - MISCELLANEOUS

---

---

---

### LOADING THE VEHICLE

*NOTE: Your motorhome's load capacity is designated by weight, not by volume, so you cannot necessarily use all available space when loading your motorhome.*

- Store or secure all loose items inside the motorhome before traveling. Possible overlooked items such as canned goods or small appliances on the countertop, cooking pans on the range, or free-standing furniture items can become dangerous projectiles during a sudden stop or evasive maneuver.
- Be aware of GVWR, GAWR, and individual load limit on each tire or set of duals.

When loading the vehicle, distribute the cargo load equally so that you do not exceed either the Front or Rear Gross Axle Weight Rating (GAWR) or the Gross Vehicle Weight Rating (GVWR). The Gross Axle Weight Rating (GAWR) means the weight value specified by the chassis manufacturer as the load carrying capacity of a single axle system as measured at the tire-to-ground interfaces. This is the total weight a given axle is capable of carrying. Each axle has its own rating.

Have your vehicle weighed to determine the proper load distribution for your vehicle. Also distribute cargo side-to-side so the weight on each tire or dual set does not exceed one half of the GAWR for either axle.

For example, if the Front GAWR is 6,000 lbs., there should be no more than 3,000 lbs. on each tire. (If the left side weighs 3,100 lbs. and the right side weighs 2,700 lbs., at least 100 lbs. of the load must be shifted from the left side to the right side.) The GVWR is listed on the Vehicle Certification Label. (See sample in *Section 1 - Introduction*).

The GCWR (Gross Combination Weight Rating) means the maximum allowable loaded weight of this motorhome and any towed trailer or towed vehicle.

*NOTE: We recommend that you dump all holding tanks before traveling to avoid carrying unnecessary weight.*

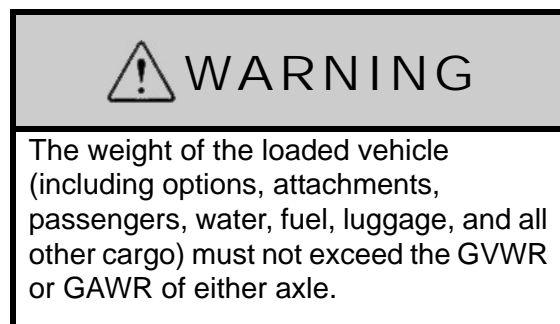

---

---

### WEIGHING YOUR LOADED VEHICLE

To check the weight of your fully loaded coach, locate a commercial weighing scale that is capable of weighing large trucks.

*NOTE: Sales literature may give approximate or standard weights. Your actual coach weight may differ based on added factory and/or dealer options.*

#### **Loading**

Load your vehicle completely as if you were going on a long trip with everything you would carry, including food, clothing, bedding, lawn chairs, etc., a full fuel tank, full propane tank, and a partial tank of fresh water, but empty holding tanks.

#### **Finding a Scale**

In urban areas, the most common places to find a public access scale are commercial truck stops. In rural areas, most grain storage elevators have scales available. Most scales charge a nominal fee for weighing a vehicle.

#### **Weighing**

There is typically a scale operator to direct you but the basic routine is to take three separate weights - front axle, whole vehicle, and rear axle.

## SECTION 12 - MISCELLANEOUS

You will first drive only your front wheels onto the scale pad, then drive ahead so that the whole vehicle is on the scale, then finally pull off until just the rear wheels are on the pad.

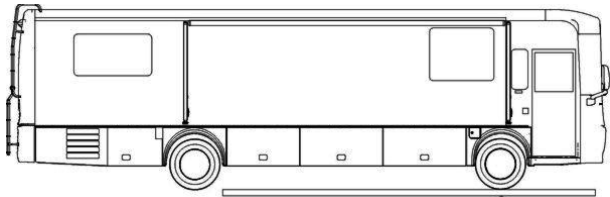

Front GAWR (Front Axle Only)

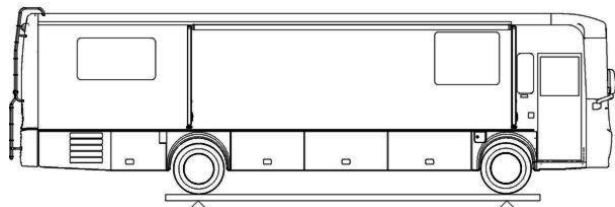

GVWR - Whole Vehicle (All Axles)

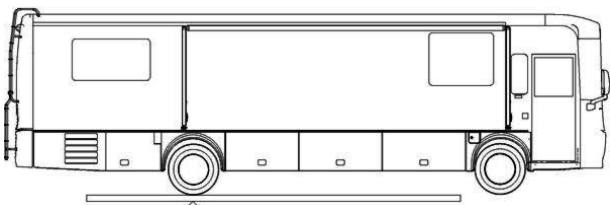

Rear GAWR (Rear Axle Only)

You will receive a weight “ticket” that states your current Front Gross Axle Weight, Rear Gross Axle Weight, and Gross Vehicle Weight. You can compare these weights to the weight ratings listed on your Vehicle Certification Label to use as a guideline for future loading limits and weight distribution.

The gross weight of the vehicle must not exceed the Gross Vehicle Weight Rating (GVWR) specified on the Vehicle Certification Label. The front and rear axle weight also should not exceed the corresponding Axle Weight Rating specified on the Vehicle Certification Label.

### Corner Weighing (Side-to-Side)

The most accurate method of weighing a motorhome is to weigh each “corner” of the coach separately (single L/R front wheels or L/R rear dual sets.) This method will help you determine how to distribute your cargo to avoid overloading, especially on tires.

To determine the weight distribution on each tire or dual set, you will need to find a scale capable weighing side-to-side, or all four “corners” of the vehicle, separately.

A truck scale may be used if the ground is level with the scale surface and the scale has clearance to drive one side of the coach onto the scale as shown.

Drive the coach on the level area next to the scale and straddle the scale so that only one side of the coach will be on the scale pad.

*NOTE: Wind and precipitation can also cause weight inaccuracies.*

Pull only the right front wheel onto the scale pad as shown.

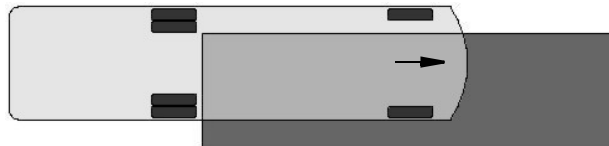

Weighing Right Front Corner

When the front wheel has been weighed, pull the coach straight ahead until only the right rear wheel/dual set is on the scale pad as shown.



Weighing Right Rear Corner

Now, turn the coach around and repeat the process for the other side.

The load on each wheel or dual-wheel set should not exceed one-half of the corresponding GAWR. For example, if the GAWR for the rear

axle is 12,000 lbs., then the load on each rear dual set (left rear duals or right rear duals) should not exceed 6,000 lbs.

Tires must be filled to the recommended air pressure for the highest loaded tire set on that axle. For example, on the rear axle, if the left side weighs more than the right, fill the left tires to the pressure required for that weight, then fill the right tires to the same pressure as the left ones.

If your actual weight is considerably less than GAWR, you may be able to lower your tire pressure. See a tire dealer for a load/pressure chart.

*NOTE: The Hitch Load from a Towed Vehicle or carrier box must also be counted on the Rear GAWR and subtracted from the rear axle cargo capacity.*

Be aware that hitch load can affect handling characteristics. The more weight on the hitch, the lighter the front end will feel at the steering wheel.

---

---

## CAR OR TRAILER TOWING

### **Hitch Capacity\***

**5,000 lbs. max.**

### **Tongue Weight\***

**500 lbs. max.**

The factory installed towing hitch on this coach is capable of pulling 5,000 lbs. load (max.), however, the vertical (tongue) weight may vary according to chassis and model combinations (\*see label on hitch). Towing capacity may be less than hitch rating.

When towing a trailer or vehicle, do not exceed either the GVWR, the rear axle GAWR, or the chassis GCWR by the combined loaded weight of the coach and the towed vehicle. *See preceding items "Loading the Vehicle" and "Weighing Your Loaded Vehicle" for explanation of weight ratings.*

Because of individual vehicle use and loading habits, we recommend weighing the vehicle while fully loaded to avoid exceeding any of the

listed Gross Weight Ratings. See "Vehicle Certification Label" in the Introduction section for information on gross weight ratings.

Towing will affect vehicle handling, durability, and fuel economy. Exceeding any of the listed Gross Weight Ratings will result in unacceptable overall vehicle performance. Maximum safety and satisfaction when towing depends on proper use of correct equipment.

When towing a vehicle behind your motorhome, the tow bar should be level or pointing slightly upward towards the tow vehicle.

When coupling the vehicle tow bar to the Factory Receiver Hitch using a "drop receiver" or a conventional "ball mount" (commonly referred to as a "stinger" or a "draw bar"), do not exceed a 4" drop, nor one that the centerline of the hitch pin to the centerline of the ball exceeds 8". See the following Hitch Assembly illustration.

If a towing "brake system" is required, we recommend that a "modulated" towed vehicle braking device be installed. This means that when the motorhome brakes are applied, whether hard or soft, a mirror effect occurs in the braking of the towed vehicle. In other words, the more force applied to the motorhome brakes, the more force will be applied to the rear vehicle's braking system.

We do not recommend the usage of a "surge-style" braking device. The usage of a surge brake (especially when coupled with a hitch ball located outside our recommended limits) places excessive stress on the hitch. This abuse of the ball mount and the hitch may cause premature hitch assembly failure.

Finally, do not forget to consider the actual tongue weight. This should not exceed the stated hitch vertical load for your vehicle. This weight is typically defined as the tongue weight of a towed vehicle hitch, boat trailer tongue weight, or a receiver-mounted carrier rack.

Check state regulations on trailer weight and trailer brake requirements to be sure you select the right equipment before towing.

## SECTION 12 - MISCELLANEOUS

Before descending a steep or long grade when towing a trailer, reduce speed and shift into a lower gear to control vehicle speed. Avoid prolonged or frequent application of brakes which could cause overheating and brake failure.

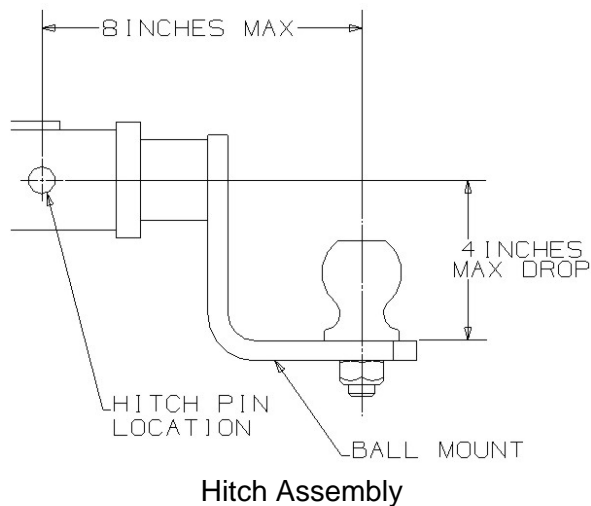

### WARNING

For safe towing and vehicle handling, maintain proper trailer weight distribution. The total weight of the motorhome and the vehicle towed must not exceed the Gross Combined Vehicle Weight rating. See the "Body and Chassis Specification" chart in the Introduction section.

### NOTICE

Exceeding any of the recommended gross vehicle weight ratings may result in vehicle damage. Do not install a frame equalizing-type hitch on your vehicle.

## TRAILER WIRING CONNECTOR

Your coach is pre-wired for trailer or car towing lights with a 7-pin socket.

The following diagram shows proper connection of trailer or tow vehicle wiring to the coach light system. The "pigtail" assembly with the (car/trailer end) connector plug should be wired by a qualified technician.

The trailer brake controller connector is located to the left of the steering column.

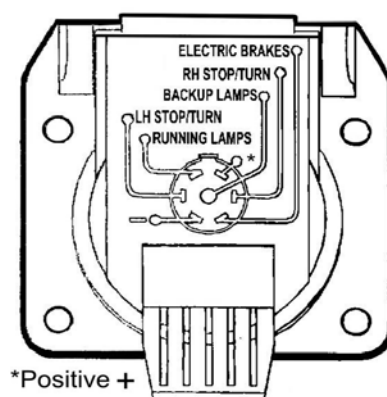

## TOWING GUIDELINES

### Gross Vehicle Weight Rating (GVWR)

This is the maximum allowable weight of the fully loaded vehicle. Included are fuel, water, LP, passengers, cargo, tools, and optional equipment installed by the motorhome manufacturer, dealer, or owner. This value is found on the VIN label, typically placed near the driver position.

### Gross Axle Weight Rating (GAWR)

This is the total weight a given axle is capable of carrying, measured at the ground. Each axle has its own rating. These values are also found on the Vehicle Certification Label: front and rear.

### Gross Combination Weight Rating (GCWR)

This is the maximum allowable weight of the motorhome and loaded trailer, including the items noted in GVWR above. For purposes of

this definition, the “trailer” can be a trailer, a vehicle towed on a dolly, or a vehicle towed by means of a tow bar. GCWR is typically specified based on durability and performance of the tow vehicle drive train: engine and cooling systems, transmission, drive line, drive axle, and others. The tow vehicle brakes may be rated for operation at GVWR, not GCWR.

*NOTE: State or provincial laws/regulations may require the “trailer” to be equipped with brakes that are activated when the motorhome brakes are applied. The user is responsible to know and understand the laws of the state or province being traveled. The Department of Transportation in a given state or province should be able to provide specific information.*

## Hitch Ratings

SAE Standard J684 defines:

- Class 1 trailers as “GVWR not to exceed 2,000 lbs”.
- Class 2 trailers as “GVWR over 2,000 lbs. and not to exceed 3,500 lbs. GVWR”.
- Class 3 trailers as “GVWR over 3,500 lbs. and not to exceed 5,000 lbs. GVWR”.
- Class 4 trailers as “GVWR over 5,000 lbs. and not to exceed 10,000 lbs. GVWR”.

Hitches are to be permanently marked with “Maximum trailer GVWR to be drawn” and “Maximum vertical tongue weight to be imposed.” The SAE standard does not specify a vertical load rating.

Traditionally, hitches are labeled 3,500/350 as Class 2, 5,000/500 as Class 3, and 10,000/1,000 as Class 4. The vertical tongue load value of 10 percent of drawn rating comes from the collective experience that 10 percent is the minimum value that provides stable towing of a trailer.

Ford’s towing guide suggests 10 to 15 percent for trailers over 2,000 lbs. Within GCWR, a Class 3 hitch allows “dingy” towing a large car or

mid-size SUV; a Class 4 hitch allows “dingy” towing a large SUV or pickup. (Hitch ratings are independent of towing vehicle ratings.)

*NOTE: Some Winnebago Industries® models equipped with a Class 3 hitch may have a label limiting vertical tongue load to 350 lbs. All Winnebago Industries models equipped with a Class IV hitch have a label limiting vertical tongue load to 500 lbs. On a 228” wheelbase, a 500-lb. load on a hitch 11’ from the rear axle will apply about 800 lbs. at the axle.*

The user must verify that the hitch equipment being used is adequate for the application.

---

---

## ENTRY STEP – ELECTRIC

### –If Equipped

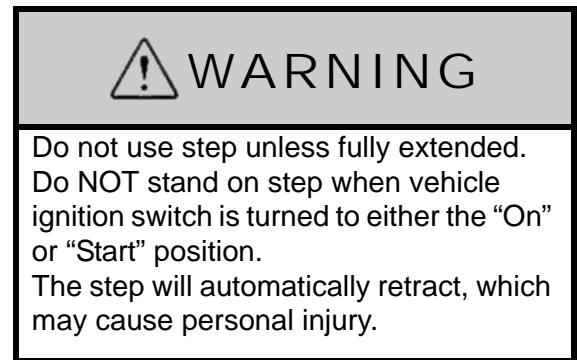

The power switch for the electric entry step is located to the left of the main entry door as you enter the coach.



Entry Step Switch  
(Located near entrance door)  
-Typical View



## SECTION 12 - MISCELLANEOUS

---

The step has several automatic extend/retract functions that are controlled by the position of a sensor mounted on the inner edge (hinge side) of the screen door.

### Automatic Mode - Entry Step Switch ON

#### (Step Operates with Door)

With the Step switch in the ON position, the step is in Automatic Mode. This means it will extend and retract automatically whenever the screen door is opened or closed.



Red Activation Lever

- The red Activation Lever located on the entry step switch must be depressed in order to put the step switch in the ON position.

### Stationary Extended Mode - Step Switch OFF

#### (Step Remains Extended)

With the Step power switch in the OFF position, the step will extend when the screen door is opened and will stay extended whether the door is opened or closed.

*NOTE: The step switch is “locked” in the OFF position.*

This position is normally used to keep the step extended when parked at a campsite or whenever people will be going in and out the vehicle frequently.

### Automatic Retraction Feature

The step is equipped with an automatic retraction feature that stores the step automatically if the main entry door is closed and the Ignition Switch key is turned to the On or Run positions.

The step WILL RETRACT even if the Step switch is OFF.

This feature is intended to prevent injury or damage by an extended step while the vehicle is moving.

### Further Information

For additional information on the step, see the manufacturer’s operators manual included in your InfoCase.

---

## WINDOWS

### Crank-Out Windows

- To open, pull out the lever on the window handle and begin cranking the window out “counter-clockwise” to desired position.



-Typical View

- To close, crank the window in snugly (by turning the window handle “clockwise”), then back off 1/4 turn to help avoid glass warping, which can result in wind noise.
- Push the lever back in on the window handle.

If the window will not open after three or more full turns of the knob, the glass may be stuck to the sealing gasket. Go to the outside of the coach and gently free the glass with your fingers. A periodic light dusting of talcum powder on the gasket should prevent this from recurring.

### **Horizontal Slider Windows**

Swing the latch handle straight out or up (depending on the style of window). Grasp the sliding window edge frame and slide the window to the side. Ensure the latch is open before trying to slide the window closed.

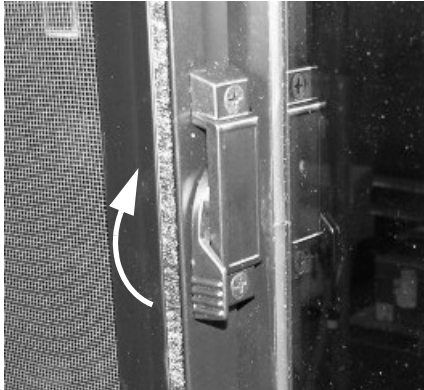

-Typical View

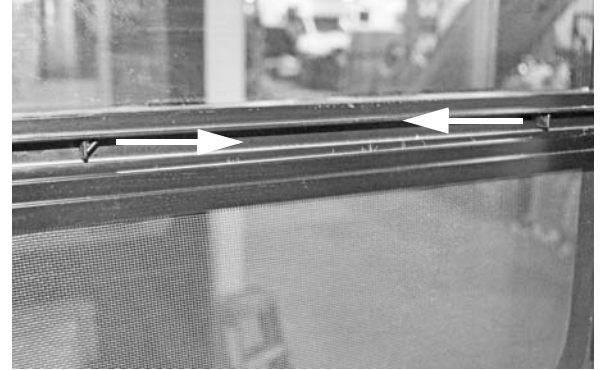

-Typical View

### **Vertical Slider Windows**

Vertical windows have spring-loaded catches on both sides of the window that pop out to hold the window in its fully raised position. Press both catches inward while opening and closing the window.

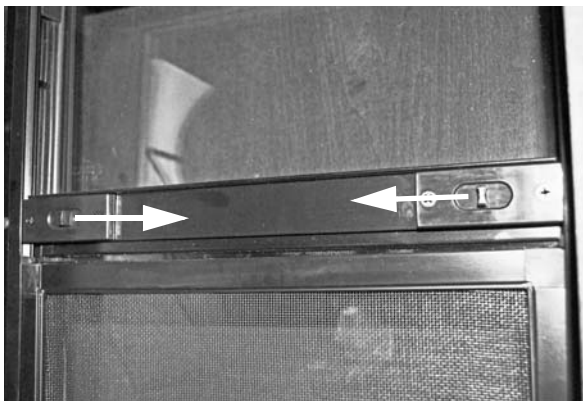

-Typical View

---

### **POWER AWNING**

#### **-If Equipped**

The Power Awning switch is located on the control panel just inside the entrance door.



Power Awning Switch  
(Located near entrance door)  
-Typical View



### **CAUTION**

Pinch Hazard. Ensure there are no people who could be harmed or objects that can be damaged. Failure to heed this warning could result in severe injury and/or property damage.

## SECTION 12 - MISCELLANEOUS

---

### Operating the Awning

- Press the Power Awning switch IN or OUT to extend or retract the Awning as desired.

### Ignition Lockout System

The ignition lockout system will disable the extend function while the vehicle ignition key is in the On position. With this feature, the Awning will only extend when the vehicle ignition key is in the Off position. The Awning can retract anytime regardless of the ignition key position.

### Further Information

For complete operating instructions, features, safety precautions, and maintenance care, refer to the Awning manufacturer's user guide provided in your InfoCase.

---

---

## STORAGE COMPARTMENT DOORS

The high-density gaskets used on the exterior storage compartments are designed to provide a more positive seal against dust and weather.

To ensure that exterior storage compartment doors have latched properly, press firmly on the bottom or side edges of the doors with the palms of your hands.

---

---

## EFFECTS OF PROLONGED OCCUPANCY

Your motorhome was designed primarily for recreational use and short-term occupancy. If you expect to occupy your coach for an extended period, be prepared to deal with condensation and humid conditions that may be encountered.

### Humidity and Condensation

Moisture condensing on the inside of windows is a visible indication that there is too much humidity inside the coach. Excessive moisture can cause water stains or mildew, which can damage interior items such as upholstery and cabinets.

When you recognize the signs of excessive moisture and condensation in your coach, you should take immediate action to minimize their effects.

You can help reduce excessive moisture inside the motorhome by taking the following steps:

#### Ventilate with outside air

Partially open one or more windows and a roof vent to circulate outside air through the coach. In cold weather, this ventilation may increase use of the furnace, but it will greatly reduce the condensation inside the coach.

#### Minimize moisture released inside the coach

Run the range hood fan while cooking and open a bath vent while bathing or showering to carry water vapor out of the coach. Avoid making steam from boiling water excessively or letting hot water run. Avoid bringing extra moisture into the coach by way of soaked clothing or snow on shoes. Do not hang-dry wet overcoats or clothing inside the coach.

# INDEX

---

About this Manual .....	1-1
Air Conditioner Filter .....	4-8
Air Conditioner/Heater – Automotive (Dash) .....	3-6
Bathroom .....	11-8
Battery Access .....	6-7
Battery Boost Switch .....	3-6
Battery Care .....	6-7
Brake-Shift Interlock .....	3-5
Bunk – Front Pull Down .....	9-4
Cabinetry – Cleaning .....	11-7
Cable TV Connection .....	8-2
Car or Trailer Towing .....	12-3
Carbon Monoxide Alarm .....	2-4
Carbon Monoxide Warning .....	2-4
Ceiling Fabric Care .....	11-6
Chassis Service and Maintenance .....	11-10
Checking Hydraulic Oil Level .....	10-7
Child Restraints .....	3-3
Circuit Breakers – House 120-Volt AC .....	6-4
Circuit Breakers and Fuses – Chassis/Dash Automotive 12-Volt .....	3-10
Circuit Breakers and Fuses – House 12-Volt DC .....	6-9
Coach Maintenance Chart .....	11-11
Dinette/Bed Conversion .....	9-1
Disinfecting Your Fresh Water System .....	7-4
Doors and Windows .....	11-9
Drainage System (P-Traps) .....	7-6
Driving Safety .....	2-1
Ducted Roof Air Conditioning System .....	4-8
Effects of Prolonged Occupancy .....	12-8
Electrical .....	2-6
Electrical Cautions .....	6-1
Electrical Generator – 120-Volt .....	6-5
Electrical Outlets – House 120-Volt AC .....	6-4
Electrical System – House 120-Volt AC .....	6-1
Electrical System – House 12-Volt DC .....	6-6
Emergency Exits .....	2-6
Engine Access – Interior .....	3-8
Engine Cooling System .....	3-9
Engine Overheat .....	2-10

---

# Index

---

Entry Step – Electric .....	12-5
Exterior Finish .....	11-2
Exterior Graphic Care .....	11-3
Exterior Lights .....	11-4
Fire Extinguisher .....	2-5
Formaldehyde Information .....	2-8
Fresh Water System .....	7-1
Front Axle Tire Alignment .....	1-2
Front Service Access .....	3-7
Front TV Ignition Switch Interlock .....	8-1
Fuel and Propane Gas .....	2-2
Galley Sink .....	11-7
General Slideout Care .....	10-5
General Warnings .....	2-1
Ground Fault Circuit Interrupter .....	6-4
Hazard Warning Flashers .....	3-6
House/Coach Battery Disconnect Switch .....	6-6
Interior Soft Goods .....	11-4
Jump Starting .....	2-10
Keys .....	3-3
Leveling System .....	10-6
Lights .....	3-10
Loading .....	2-6
Loading the Vehicle .....	12-1
Lounge Chair - Swivel .....	9-1
Maintenance .....	2-6
Map Light Switch .....	3-6
Microwave Oven .....	4-4
Mirrors – Power Electric .....	3-4
Mold, Moisture, and Your Motorhome .....	2-8
Occupant and Cargo Carrying Capacity Label .....	1-3
Owner and Vehicle Information .....	1-6
Park Brake – Foot Pedal .....	3-5
Plastic Parts – Cleaning .....	11-3
Power Awning .....	12-7
Power Center .....	6-3
Power Cord – External .....	6-1
Pre-Delivery Inspection .....	1-2
Pressure-Temperature Relief Valve .....	4-6
Propane Gas Furnace .....	4-7
Propane Gas Leak Detector .....	2-3
Propane Gas Leaks .....	2-3

---

---

Propane Gas Pressure Regulator .....	5-4
Propane Gas Supply .....	5-1
Propane Gas Warnings and Precautions .....	5-3
Propane Vaporization in Cold Weather .....	5-5
Radio – In-Dash .....	3-7
Radio Power Switch .....	3-7
Range and Oven .....	4-2
Range and Refrigerator .....	11-7
Range Hood .....	4-4
Rearview Monitor System .....	3-4
Refrigerator .....	4-1
Refrigerator Service Access Compartment .....	4-2
Reporting Safety Defects .....	1-2
Roadside Emergency .....	2-9
Roller Shades .....	9-5
Roof .....	11-1
Roof .....	2-8
Safe Use of the Propane Gas System .....	5-2
Safety Messages Used in this Manual .....	1-1
Sealants – Inspection and General Information .....	11-1
Seat Belts .....	3-2
Seats – Driver/Co-Pilot .....	3-1
Service and Assistance .....	1-2
Shower Hose Vacuum Breaker .....	7-5
Sleeping Facilities .....	9-1
Slideout Emergency Retraction (Lippert) .....	10-4
Slideout Room – Extreme Weather Precaution .....	10-2
Slideout Room Keylock .....	10-1
Slideout Room Operation – Electric .....	10-1
Slideout Room Troubleshooting (Lippert) .....	10-3
Slideout Rooms .....	2-7
Smoke Alarm .....	2-5
Sofa/Bed Conversion .....	9-3
Specifications and Capacities .....	1-5
Storage Compartment Doors .....	12-8
Suspension Alignment and Tire Balance .....	3-9
Systems Monitor Panel .....	4-4
Tables and Countertops .....	11-7
Tires .....	3-9
Toilet .....	7-5
Tow/Haul Transmission Mode .....	3-5
Towing Guidelines .....	12-4

---

## Index

---

Trailer Wiring Connector .....	12-4
TV Antenna - Digital .....	8-1
TV Signal Amplifier .....	8-2
Undercarriage .....	11-1
U-Shaped Dinette/Bed Conversion .....	9-3
Vehicle Certification Label .....	1-4
Vehicle Storage – Preparation .....	11-9
Vehicle Storage – Removal .....	11-10
Vinyl Flooring .....	11-7
Waste Water System .....	7-6
Water Heater – Gas .....	4-5
Water Heater Bypass and Antifreeze Siphon Valves .....	7-8
Water Pump .....	7-2
Water System Drain Valve Locations .....	7-13
Waterline & Tank Drain Valves .....	7-7
Weighing Your Loaded Vehicle .....	12-1
Windows .....	12-6
Winterizing Procedure .....	7-8
Wood Furniture and Cabinetry .....	9-5

---