

Chalet

TABLE OF CONTENTS

INTRODUCTION 1

About this Manual	1-1
Safety Messages Used in this Manual	1-1
Pre-Delivery Inspection	1-2
Front Axle Tire Alignment	1-2
Service and Assistance	1-2
Reporting Safety Defects	1-2
Occupant and Cargo Carrying Capacity Label	1-3
Vehicle Certification Label	1-4
Specifications and Capacities	1-5
Owner and Vehicle Information	1-6

SAFETY AND PRECAUTIONS 2

General Warnings	2-1
Driving Safety	2-1
Fuel and Propane Gas	2-1
Propane Gas Leaks	2-2
Propane Gas Leak Detector	2-3
Carbon Monoxide Warning	2-3
Carbon Monoxide Alarm	2-3
Smoke Alarm	2-4
Fire Extinguisher	2-5
Electrical	2-5
Loading	2-5
Maintenance	2-6
Emergency Exits	2-6
Slideout Rooms	2-6
Roof and Ladders	2-7
Formaldehyde Information	2-7
Mold, Moisture, and Your Motor Home	2-8
Roadside Emergency	2-9
Jump Starting	2-9
Engine Overheat	2-10

DRIVING YOUR MOTOR HOME 3

Seats – Driver/Co-Pilot	3-1
Seat Belts	3-2
Child Restraints	3-3
Keys	3-5
Rearview Monitor System	3-5
Mirrors – Power Electric	3-6

Table Of Contents

Brake-Shift Interlock	3-6
Park Brake – Foot Pedal	3-6
Tow/Haul Transmission Mode	3-7
Map Light Switch	3-7
Hazard Warning Flashers	3-7
Battery Boost Switch	3-7
Air Conditioner/Heater – Automotive (Dash)	3-8
Heater – Rear Coach (Automotive)	3-8
Defrost Fans	3-8
Radio Power Switch	3-9
Radio – In-Dash	3-9
Radio - In-Dash	3-9
CB Radio Power Wiring	3-9
Front Service Access	3-10
Engine Access – Interior	3-10
Engine Cooling System	3-11
Chassis Battery Disconnect Switch	3-12
Tires	3-12
Suspension Alignment and Tire Balance	3-12
Lights	3-12
Circuit Breakers and Fuses – Chassis/Dash Automotive 12-Volt	3-13

APPLIANCES AND SYSTEMS 4

Refrigerator	4-1
Refrigerator Service Access Compartment	4-2
Range and Oven	4-2
Microwave Oven	4-4
Microwave Oven/Range Hood	4-4
Range Hood	4-4
Systems Monitor Panel	4-4
Power Control System (PCS)	4-6
Water Heater – Gas	4-7
Water Heater - Gas/ Electric	4-7
MotorAid Water Heater	4-8
Pressure-Temperature Relief Valve	4-8
Propane Gas Furnace	4-9
Heat Pump	4-10
Ducted Roof Air Conditioning System	4-11
Air Conditioner Filter	4-11
Rear Air Conditioner Power Selector Switch	4-11

PROPANE GAS 5

Propane Gas Supply	5-1
Safe Use of the Propane Gas System	5-2
Propane Gas Warnings and Precautions	5-3
Propane Gas Pressure Regulator	5-4

Propane Vaporization in Cold Weather	5-5
ELECTRICAL 6	
Electrical Cautions	6-1
Electrical System – House 120-Volt AC	6-1
External Power Cord	6-1
Inverter Unit – 1000W	6-3
Power Center	6-4
Circuit Breakers – House 120-Volt AC	6-5
Electrical Outlets – House 120-Volt AC	6-5
Ground Fault Circuit Interrupter	6-6
Electrical Generator – 120-Volt	6-6
Electrical System – House 12-Volt DC	6-7
House/Coach Battery Disconnect Switch	6-8
Battery Access	6-8
Battery Care	6-9
Circuit Breakers and Fuses – House 12-Volt DC	6-10
PLUMBING 7	
Fresh Water System	7-1
Water Pump	7-2
Disinfecting Your Fresh Water System	7-4
Shower Hose Vacuum Breaker	7-5
Exterior Shower/Wash Station	7-5
Toilet	7-6
Drainage System (P-Traps)	7-6
Waste Water System	7-6
Waste Water System (Waste Pump)	7-8
WaterLine & Tank Drain Valves	7-10
Water Heater Bypass Valve	7-11
Winterizing Procedure	7-12
Water System Drain Valve Locations	7-17
ENTERTAINMENT 8	
Audio/Video System Cables	8-1
Front TV Ignition Switch Interlock	8-1
Audio-Video System Basic Operation	8-1
DVD Player	8-1
CD/DVD Player	8-2
Flip-Down Screen Video Players	8-3
Bedroom DVD/Satellite Receiver Connection	8-4
TV Antenna - Digital	8-5
TV Signal Amplifier	8-6
TV Digital Satellite System Wiring	8-6
Satellite Dish and Cable TV Connections	8-6
Exterior Entertainment Center	8-6

Exterior Entertainment Center	8-7
FURNITURE AND SOFTGOODS 9	
Lounge Chair – Swivel Glider	9-1
Sleeping Facilities	9-1
Buffet Table and Chairs	9-1
Dinette/Bed Conversion	9-3
Dinette/Bed Conversion - Dream Dinette™	9-4
U-Shaped Dinette/Bed Conversion	9-5
Dinette Conversion	9-6
Sofa/Bed Conversion	9-7
Sofa/Bed Conversion	9-7
Sofa/Bed removable Armrests	9-8
Comfort Sofa Sleeper	9-9
Extendable Sectional Sofa	9-12
Roller Shades (Manual) - Solar Day/Night	9-13
Wood Furniture and Cabinetry	9-13
SLIDEOUT ROOMS AND LEVELING 10	
Slideout Room Travel Locks - Electric	10-1
Slideout Room Travel Lock	10-2
Slideout Room Operation – Electric	10-3
Slideout Room – Extreme Weather Precaution	10-5
Slideout Room Troubleshooting	10-6
Slideout Emergency Retraction (Power Gear®)	10-8
Slideout Emergency Retraction (Power Gear®)	10-9
Slideout Emergency Retraction - Bedroom	10-10
General Slideout Care	10-11
Leveling System	10-11
Checking Hydraulic Oil Level	10-13
MAINTENANCE AND STORAGE 11	
Sealants – Inspection and General Information	11-1
Roof	11-1
Undercarriage	11-1
Exterior Automotive Paint Finish	11-2
Exterior Graphic Care	11-4
Plastic Parts – Cleaning	11-4
Interior Soft Goods	11-5
Ceiling Fabric Care	11-7
Cabinetry – Cleaning	11-8
Tables and Countertops	11-8
Stainless Steel Appliances	11-8
Galley Sink	11-9
Range and Refrigerator	11-9
Vinyl Flooring	11-9

Chalet

Bathroom	11-10
Doors and Windows	11-10
Vehicle Storage – Preparation	11-11
Vehicle Storage – Removal	11-11
Chassis Service and Maintenance	11-12
Coach Maintenance Chart	11-13

MISCELLANEOUS 12

Loading the Vehicle	12-1
Weighing Your Loaded Vehicle	12-1
Car or Trailer Towing	12-3
Trailer Wiring Connector	12-4
Towing Guidelines	12-4
Entry Step – Electric	12-5
Windows	12-6
Power Roof Ventilator	12-7
Power Roof Ventilator Wiring	12-8
Power Awning	12-8
Storage Compartment Doors	12-8
Tool and Ladder Storage	12-8
Roof Ladder	12-8
Effects of Prolonged Occupancy	12-9

Chalet

SECTION 1 - INTRODUCTION

Congratulations! We welcome you to the exciting world of motorhome travel and camping. You will find it convenient and enjoyable to have all the comforts of home and still enjoy the great outdoors wherever you choose to go. Your motorhome has been carefully designed, engineered, and manufactured to provide years of enjoyment.

Before sliding into the driver's seat, please become familiar with operations and features. In addition, spend some time with the dealer when you take delivery to learn all you can about your new motorhome.

ABOUT THIS MANUAL

This operator's manual was prepared to aid you in the proper care and operation of the vehicle and equipment.

Please read this manual completely to understand how everything in your coach works before taking it on its "maiden voyage". In addition, please become familiar with the New Vehicle Limited Warranty.

NOTE: This manual describes many features of your motorhome and includes instructions for its safe use.

This manual, including photographs and illustrations, is of a general nature only.

Some equipment and features described or shown in this manual may be optional or unavailable on your model.

Because of Winnebago Industries[®], continuous program of product improvement, it is possible that recent product changes and information may not be included.

The instructions included in this manual are intended as a guide, and in no way extend the responsibilities of Winnebago Industries beyond the standard written warranty as presented in this manual.

The descriptions, illustrations, and specifications in this manual were

correct at the time of printing. We reserve the right to change specifications or design without notice, and without incurring obligation to install the same on products previously manufactured.

The materials in your InfoCase contain warranty information and operating and maintenance instructions for the various appliances and components in your motorhome.

NOTE: Many of the instruction sheets and manuals for the various appliances and components have been incorporated into the Operator's Manual Supplement for your convenience.

Please read the FAQ in Section 1 of the Operator's Manual Supplement for more details.

Throughout this manual, frequent reference is made to the vehicle chassis manual that is provided by the manufacturer of the chassis on which this motorhome is built.

Consult the chassis manual for operating, safety, and maintenance instructions pertaining to the chassis section of the motorhome.

SAFETY MESSAGES USED IN THIS MANUAL

Throughout this manual, certain items are labeled Danger, Warning, Caution, Notice, or Note. These terms alert you to precautions that may involve damage to your vehicle or a risk to your personal safety. Read and follow them carefully.



DANGER

DANGER indicates a hazardous situation which, if not avoided, will result in death or serious personal injury.



WARNING

WARNING indicates a hazardous situation which, if not avoided, could result in death or serious personal injury.



CAUTION

CAUTION indicates a hazardous situation which, if not avoided, could result in minor or moderate personal injury.

NOTICE

NOTICE is used to address practices not related to personal injury.

NOTE: A “Note” is not necessarily safety-related, but indicates a recommendation or special point of information that could assist in understanding the use or care of a feature item.

PRE-DELIVERY INSPECTION

This motorhome has been thoroughly inspected before shipment. Your dealer is responsible for performing a complete pre-delivery inspection of the chassis and all motorhome components.

As a part of the pre-delivery inspection procedure, the dealer is responsible for road testing the motorhome, noting, and correcting any problems before delivery.

**FRONT AXLE TIRE
ALIGNMENT**

We recommend that you have the front suspension and steering alignment checked and adjusted after you have fully loaded the vehicle according to your needs. Thereafter, have alignment inspected periodically to maintain vehicle steering performance and prevent uneven tire wear.

SERVICE AND ASSISTANCE

Your dealer will be glad to provide any additional information you need, as well as answer any questions you might have about operating the equipment in your coach. When it comes to service, remember that your dealer knows your vehicle best and is interested in your satisfaction. Your dealer will provide quality maintenance and any other assistance that you may require during your ownership of this vehicle.

If you need warranty repairs while traveling, you may take your vehicle to any authorized Winnebago Industries® dealership and request their assistance.

See the Service Dealer Directory in your InfoCase.

REPORTING SAFETY DEFECTS

If you believe that your vehicle has a defect which could cause a crash or could cause injury or death, you should immediately inform the National Highway Traffic Safety Administration (NHTSA) in addition to notifying Winnebago Industries, Inc.

If NHTSA receives similar complaints, it may open an investigation, and if it finds that a safety defect exists in a group of vehicles, it may order a recall and remedy campaign. However, NHTSA cannot become involved in individual problems between you, your dealer, or Winnebago Industries®.

To contact NHTSA, you may either call the Vehicle Safety Hotline toll-free at:
1-888-327-4236; (TTY: 1-800-424-9153)

or go to their website at <http://www.safercar.gov>
or write to:

Administrator, NHTSA
1200 New Jersey Avenue S.E.
Washington, D.C. 20590

You can also obtain other information about
motor vehicle safety from the NHTSA website
at <http://www.safercar.gov>

OCCUPANT AND CARGO CARRYING CAPACITY LABEL

This label is affixed in the driver's area next to
or near the Vehicle Certification Label. It
contains vehicle occupant and cargo carrying
capacity along with the number of seat belt
positions in the vehicle. The label also provides
the weight of a full load of water and advises that
this weight, along with the tongue weight counts
as cargo.

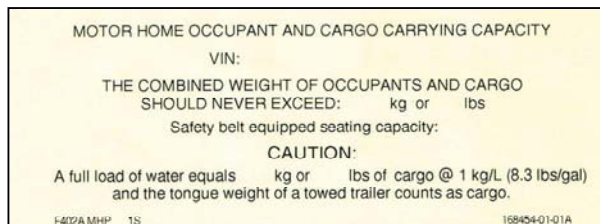

If any weight exceeding 45.4 kg (100 lbs.) is
added to your coach between final vehicle
certification and first retail sale, the occupant and
cargo carrying capacity must be corrected and a
label similar to the one shown below will be
affixed inside your coach.



SPECIFICATIONS AND CAPACITIES

Chalet	26PR	30TR	32KR	35FR	36DR
	Ford® F53 16,000 lb. Chassis with 19.5" Tires	Ford® F53 18,000 lb. Chassis with 19.5" Tires	Ford® F53 20,500 lb. Chassis with 19.5" Tires	Ford® F53 22,000 lb. Chassis with 22.5" Tires	Ford® F53 22,000 lb. Chassis with 22.5" Tires
Feature Number	16N	16H	16M	16L	16L
Length	26' 11.1"	30' 11.3"	33' 0.7"	35' 2.5"	36' 3.4"
Exterior Height ¹	12' 1"	12' 2"	12' 4"	12' 5"	12' 5"
Exterior Width ²	8' 5.5"	8' 5.5"	8' 5.5"	8' 5.5"	8' 5.5"
Exterior Storage ³	54.0 cu. ft.	78.4 cu. ft.	84.0 cu. ft.	130.5 cu. ft.	137.0 cu. ft.
Awning Length	11' 6"	17'	13'	16'	18'
Interior Height	6' 8"	6' 8"	6' 8"	6' 8"	6' 8"
Interior Width	8' 0.5"	8' 0.5"	8' 0.5"	8' 0.5"	8' 0.5"
Freshwater Tank Capacity ⁴	54 gal.	78 gal.	70 gal.	74 gal.	68 gal.
Water Heater Capacity	6 gal.	6 gal.	6 gal.	6 gal.	6 gal.
Holding Tank Capacity - Black ⁴	43 gal.	41 gal.	46 gal.	41 gal./21 gal.	48 gal.
Holding Tank Capacity - Gray ⁴	38 gal.	42 gal.	58 gal.	51 gal.	45 gal.
Propane Capacity ⁵	18 gal.	18 gal.	18 gal.	18 gal.	18 gal.
Wheelbase	158"	190"	208"	228"	242"
GVWR	16,000 lbs.	18,000 lbs.	20,500 lbs.	22,000 lbs.	22,000 lbs.
GAWR - Front	6,500 lbs.	7,000 lbs.	7,000 lbs.	8,000 lbs.	8,000 lbs.
GAWR - Rear	11,000 lbs.	12,000 lbs.	13,500 lbs.	15,000 lbs.	15,000 lbs.
GCWR ⁶	26,000 lbs.	26,000 lbs.	26,000 lbs.	26,000 lbs.	26,000 lbs.
Fuel Capacity	80 gal.	80 gal.	80 gal.	80 gal.	80 gal.

Notes:

All measurements are based upon the most recent data available. See your dealer for specifications.

¹ The height of each model is measured to the top of the tallest standard feature and is based on the curb weight of a typically equipped unit. The actual height of your vehicle may vary by several inches depending on chassis or equipment variations. Contact your dealer for further information.

² Floorplans feature a wide-body design - over 96". You should be aware that some states restrict access on some or all state roads to 96" in body width. You should confirm the road usage laws in the states of interest to you.

³ The load capacity of your motor home is designated by weight, not by volume, so you cannot necessarily use all available space when loading your motor home.

⁴ Capacities are based on measurements prior to tank installation. Slight capacity variations can result upon installation.

⁵ Capacities shown are the tank manufacturer's listed water capacity (W.C.). Actual filled propane capacity is 80% of listing due to overfilling prevention device on tank.

⁶ Actual towing capacity is dependent on your particular loading and towing circumstances which includes the GVWR, GAWR, and GCWR as well as adequate trailer brakes. Refer to the chassis operator's manual of your motor home for further towing information.

**SECTION 1 -
INTRODUCTION**



OWNER AND VEHICLE INFORMATION

OWNER INFO

Owner's Name(s) _____

Address _____

VEHICLE INFORMATION

Motorhome Model Number _____

Motorhome Serial Number _____

Chassis Vehicle Identification No. (VIN) _____

Vehicle Mileage at Delivery _____

Selling Dealer Name _____

Address _____

YOUR WINNEBAGO INDUSTRIES® DEALER /SERVICE CENTER

Name _____

Address _____

Contact _____ Phone _____

CHASSIS SERVICE CENTER

Name _____

Address _____

Contact _____ Phone _____

RV INSURANCE POLICY

Company _____

Policy Number _____

Agent _____ Phone _____

Chalet

SECTION 2 - SAFETY AND PRECAUTIONS

GENERAL WARNINGS

- Only seats equipped with seat belts are to be occupied while the vehicle is moving.
- Make sure all passengers have seat belts fastened. Lap belts should fit low on the hips and upper thighs. The shoulder belt should be positioned snug over the shoulder.
- For pregnant women: Never place the shoulder belt behind your back or under your arm. Adjust the lap belt across your hips/pelvis, and below your belly. Place the shoulder belt across your chest (between your breasts) and away from your neck.
- Child restraints should be installed properly according to manufacturer's instructions. See "Child Restraints".
- All moveable or swiveling seats should be placed and locked in travel position while the vehicle is moving.
- Never let passengers stand or kneel on seats while the vehicle is moving.
- Sleeping facilities are not to be utilized while vehicle is moving.
- Examine the escape window and be familiar with its operation.
- Inspect the fire extinguisher monthly for proper charge and operating condition. This should also be done before beginning a vacation or any extended trip.

DRIVING SAFETY

- Do not attempt to adjust the driver's seat while the vehicle is moving.
- Do not adjust tilt steering in a moving vehicle.
- Do not operate the cruise control on icy or extremely wet roads, winding roads, in heavy traffic, or in any other traffic situation where a constant speed cannot be maintained.

- Use care when accelerating or decelerating on a slippery surface. Abrupt speed changes can cause skidding and loss of control.
- Never drive the vehicle with a slideout room extended.
- Driving through water deep enough to wet the brakes may affect stopping distance or cause the vehicle to pull to one side. Check brake operation in a safe area to be sure they have not been affected. Never operate any vehicle if a difference in braking efficiency is noticeable.
- Adverse weather conditions and extremes in terrain may affect handling and/or performance of your vehicle. Refer to your chassis manual for complete and related information on driving your vehicle.

FUEL AND PROPANE GAS

 **DANGER**

All pilot lights, appliances, and their ignitors (see operating instructions) shall be turned off before refueling of motor fuel tanks and/or propane containers. Failure to comply could result in death or serious injury.

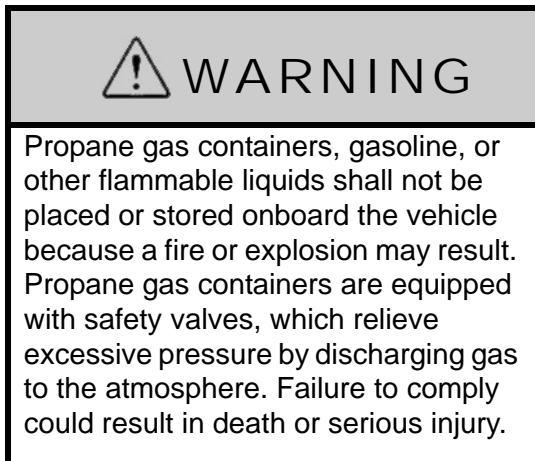

- All pilot lights must be extinguished and appliances turned off while refilling the fuel tank or propane gas tank.
- Never smoke while refilling vehicle fuel tank or propane gas tank.
- Never use an open flame to test for propane gas leaks. Replace all protective covers and caps on propane system after filling. Make sure valve is closed and the door is latched securely.
- Never connect natural gas to the propane gas system.
- When lighting range burners, **do not** turn burner controls to “On” and allow gas to escape before lighting match.
- Portable fuel-burning equipment, including wood and charcoal grills and stoves shall not be used inside the recreational vehicle. The use of this equipment inside the recreational vehicle may cause fires or asphyxiation.
- Propane gas regulators must always be installed with the diaphragm vent facing downward. Regulators are equipped with a protective cover. Make sure that the regulator vent faces downward and that the cover is kept in place to minimize vent blockage, which could result in excessive gas pressure causing fire or explosion.
- The following warning label is located in the cooking area to remind you to provide an adequate supply of fresh air for combustion.

Unlike homes, the amount of oxygen supply is limited due to the size of the recreational vehicle, and proper ventilation when using the cooking appliance(s) avoids dangers of asphyxiation. It is especially important that cooking appliances not be used for comfort heating, as the danger of asphyxiation is greater when the appliance is used for long periods of time. Failure to comply could result in death or serious injury.

PROPANE GAS LEAKS

Check propane gas system for leaks yearly, or as necessary.

The following procedures are noted on a label, located in the vehicle near the range area. If you smell gas within the vehicle, quickly and carefully perform the procedures listed.

IF YOU SMELL PROPANE

- Extinguish any open flames, pilot lights, and all smoking materials.
- Do not touch electrical switches.
- Shut off the gas supply at the tank valve(s) or gas supply connection.
- Open doors and other ventilating openings.
- Leave the area until odor clears.
- Have the propane system checked and leakage source corrected before using again.

Failure to comply could result in death or serious injury.

PROPANE GAS LEAK DETECTOR

Your coach is equipped with a Propane Gas Leak Detector, similar to the one shown below. The leak detector sounds an alarm if an unsafe amount of propane gas is present inside the coach.



Propane Gas Leak Detector

 **WARNING**

EXPLOSION HAZARD: DO NOT use an open flame to test for gas leaks. When testing for gas line leaks with a soapy water solution, DO NOT use a detergent containing ammonia or chlorine. These substances may generate a chemical reaction causing corrosion to gas lines, resulting in dangerous leak conditions. Death or serious injury can result.

Power Connection

The Propane Gas Leak Detector is powered by the house batteries. If the House/Coach Battery Disconnect switch is shut off or the battery cable is disconnected from the batteries, the alarm will not work. The Propane Gas Leak Detector fuse or circuit breaker is located in the 12-volt house electrical load center.

Because the Propane Gas Leak Detector is connected to the house battery, it is always drawing a small amount of current. Even though this current draw is slight, it could drain the house

battery during storage periods when the house battery will not be charged regularly by the engine or shoreline.

Further Information

See the manufacturer's user guide provided in your InfoCase for further instructions.

CARBON MONOXIDE WARNING

 **WARNING**

Avoid inhaling exhaust gases, as they contain carbon monoxide, which is a colorless, odorless, and poisonous gas. Death or serious injury can result.

The best protection against carbon monoxide entry into the vehicle body is a properly maintained engine exhaust and ventilation system. It is recommended that the exhaust system and body be inspected by a qualified motorhome service center:

- Each time the vehicle is serviced for an oil change.
- Whenever a change in the sound of the exhaust system is noticed.
- Whenever the exhaust system, underbody, or rear of the vehicle is damaged.

To allow proper operation of the vehicle's ventilation system, keep front ventilation inlet grill clear of snow, leaves, or other obstructions at all times. **DO NOT OCCUPY A PARKED VEHICLE WITH ENGINE RUNNING FOR AN EXTENDED PERIOD.**

Do not run engine in confined areas, such as a garage, except to move vehicle into or out of the area.

CARBON MONOXIDE ALARM

Your coach is equipped with a Carbon Monoxide (CO) Alarm (located on the ceiling in the bedroom area.) The CO Alarm is powered by

SECTION 2 - SAFETY AND PRECAUTIONS

a 9-volt battery and has a sensor that is designed to detect toxic carbon monoxide gas fumes resulting from incomplete combustion of fuel. It will detect CO gas from any combustion source such as the furnace, gas range/oven, water heater, refrigerator, chassis engine, and electric generator engine.



Carbon Monoxide Alarm



Smoke Alarm

The following label is affixed to the Smoke Alarm.

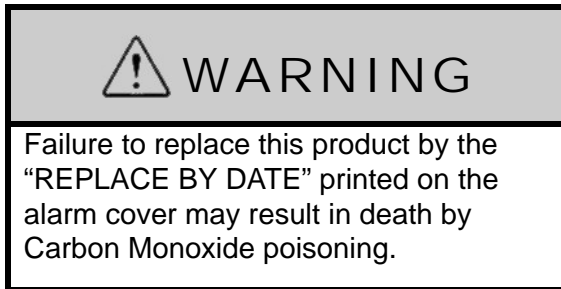

Replacement

When replacing this alarm, we recommend replacing only with the same model, or with one that is also listed for RV application. We recommend obtaining a replacement from your Winnebago Industries® dealer.

Further Information

Please read the information provided by the manufacturer, which is included in your InfoCase for further information.



Replacement

When replacing this alarm, we recommend replacing only with the same model, or with one that is also listed for RV application. We recommend obtaining a replacement from your Winnebago Industries® dealer.

Further Information

See the manufacturer's information in your InfoCase for further instructions.

FIRE EXTINGUISHER

A dry chemical Fire Extinguisher is located near the main entrance door.



Fire Extinguisher
(Typical installation - your coach may vary according to model and floorplan)

We recommend that you become thoroughly familiar with the operating instructions displayed on the side of the Fire Extinguisher and in the information supplied in your InfoCase.

We also recommend that you inspect the Fire Extinguisher for proper charge at least once a month in accordance with National Fire Protection Association (NFPA) recommendations as stated on the label.

If the charge is insufficient, the Fire Extinguisher must be replaced.

NOTICE

Do not test the fire extinguisher by discharging it. Partial discharge can cause leakage of pressure or contents, which would render the unit inoperative when needed. When using the fire extinguisher, aim the spray at the base of the fire.

Replacement

If for any reason you must replace the Fire Extinguisher, the replacement must be the same type and size as the one originally supplied in your coach. We recommend obtaining a replacement only from your Winnebago Industries® dealer or a reliable RV parts supplier.

ELECTRICAL

- Careless handling of electrical components can be fatal. Never touch or use electrical components or appliances while feet are bare, while hands are wet, or while standing in water or on wet ground.
- Improper grounding of the vehicle can cause personal injury. Do not plug the utility power cord into an outlet which is not grounded and do not adapt the plug to connect to a receptacle for which it is not designed.
- Do not attach an extension cord to the utility power cord.
- Do not use any electrical device that has had the ground pin removed.
- Avoid overloading electrical circuits. Replace fuses or circuit breakers with those of the same size and amperage rating only. Never use a higher rated fuse or breaker.
- Use caution when handling or working near electrical storage batteries. Always remove jewelry and wear protective clothing and eye covering. Avoid creating sparks.

LOADING

- Store or secure all loose items inside the motorhome before traveling. Possible overlooked items such as canned goods or small appliances on the countertop, cooking pans on the range, or free-standing furniture items can become dangerous projectiles during a sudden stop.
- Be aware of GVWR, GAWR, and individual load limit on each tire or set of duals (See “Loading the Vehicle” in *Section 12 - Miscellaneous*).
- Never load the motorhome in excess of the gross vehicle weight rating of the gross axle weight rating for either axle.

SECTION 2 - SAFETY AND PRECAUTIONS

Chalet

MAINTENANCE

- Do not remove the radiator cap while engine and radiator are still hot. Always check coolant level visually at the see-through coolant reservoir.
- Never get beneath a vehicle that is held up by a jack only.
- Do not mix different construction types of tires on the vehicle, such as radial, bias, or belted tires, as vehicle handling may be affected. Replace tires with exact size, type, and load range.
- Refer to your chassis manual for complete maintenance precautions and recommendations.

EMERGENCY EXITS

Escape Window

The bedroom escape window is secured by two red safety latches at the bottom of the window.

To open, lift both latches up and toward the center of the window, then push outward near the bottom of the window.

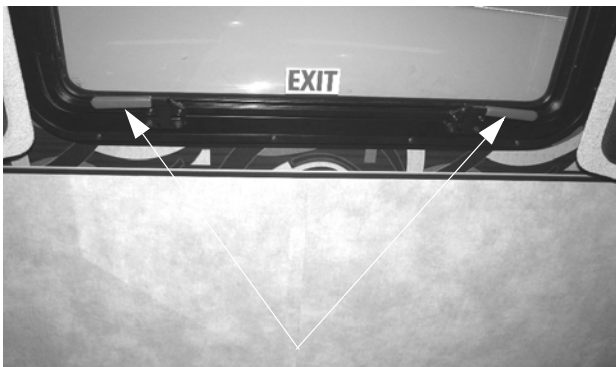

Escape Window
(Lift latch handles upward to open)

Using Slider Windows As Emergency Exits

Some coaches are required to have a slider window as an alternate exit. This window will be marked EXIT and have a red-handled latch.

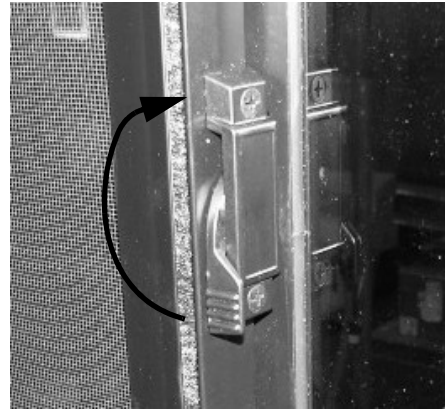

Pull latch UP to slide window open

Most slider windows along the side of any motorhome can also be used as alternate emergency exits, should the need arise.

To use a slider windows as an exit, first slide the window open, then either slide the screen open or push the screen material out, depending on window construction.

SLIDEOUT ROOMS

WARNING

Your motorhome may have more than one slideout room. Understand which switch operates which slideout room prior to operation. Make sure all slideout rooms are clear of people who could be harmed or obstacles that could cause damage prior to operating any slideout rooms. Failure to observe can result in death or serious injury.

Check inside and outside the vehicle to make sure that there are no people who could be harmed or obstacles that could cause damage due to room activation.

WARNING

Keep all persons clear of the slideout room and moving parts while extending or retracting. Do not occupy the slideout room while it is being extended or retracted. Failure to observe can result in death or serious injury.

WARNING

Do not exceed 225-lb. maximum weight capacity. Misuse of ladder could result in death or serious injury. See Operator's Manual before using ladder.

ROOF AND LADDERS

WARNING

Stay off roof. Roof surface may be slippery. Falling could result in death or serious injury.

The ladder on your motorhome is provided for limited access to the roof.

Walking or working on the roof should be left to qualified service personnel using proper safety equipment in a safe environment. You should only walk or work on the roof if you are qualified and have created a safe environment.

For your safety, it is not recommended that you store or carry items on the roof.

Before Using the Ladder

- **Inspect the ladder** to make sure it is not damaged. Never use a damaged ladder.
- **Keep the rungs of the ladder clean and dry** while in use. Never use the ladder when it is raining, snowing, or icy. The rungs can become slippery. Do not step onto the rungs if the rungs are wet, or if your shoes are wet or carry mud or debris that could result in a loss of footing.
- **Never ignore warning labels** or weight limits defined on your ladder. The following warning label is located on or near the ladder:

- **Maximum Capacity: 225 lbs.**
- **Do not overload.** Ladder is intended for one person.
- **Make sure you are physically capable** to safely use the ladder. Strength, flexibility, and stability are required.
- **Be aware that the vehicle may sway** as you climb the ladder. Do not use the ladder in high winds.
- **As you climb the ladder,** grasp the side rails firmly and always use both hands. Keep your body centered between the side rails. Do not over-reach.
- **Never allow children** on the ladder.
- **Do not transport items** anchored to the ladder. You could damage the ladder.

FORMALDEHYDE INFORMATION

Some of the materials used in this recreational vehicle emit formaldehyde. Eye, nose, and throat irritation, headache, nausea, and a variety of asthma-like symptoms, including shortness of breath have been reported as a result of formaldehyde exposure. Reaction to formaldehyde exposure may vary among individuals. Elderly persons and young children, as well as anyone with a history of asthma, allergies, or lung problems may be at greater risk. Research is continuing on the possible long-term effects of exposure to formaldehyde. Inadequate ventilation may allow formaldehyde and other contaminants to accumulate in indoor air. Ventilation to dilute the indoor air may be obtained from a passive or mechanical ventilation system. Always be sure to thoroughly

ventilate your recreational vehicle before and during each use. High indoor temperatures and humidity may raise formaldehyde levels. When a recreational vehicle is in areas subject to high temperatures, an air conditioning system can be used to control indoor temperature levels. If you have any questions regarding the health effects of formaldehyde, consult your doctor or local health department.

MOLD, MOISTURE, AND YOUR MOTOR HOME

What is Mold?

Molds are part of the natural environment. They are as old as the Earth itself and mold spores are almost everywhere at some level waiting to grow. Mold plays a part of nature by breaking down dead organic matter, such as fallen leaves and dead trees. Indoors however, mold growth should be avoided. Molds reproduce by means of tiny spores. Those spores are invisible to the naked eye and float throughout the outdoor and indoor air. Because of the nature of the use of a motorhome, it is natural for a motorhome to be introduced into an environment with mold spores.

Mold is a plant and requires its own special environment to grow. That environment includes organic materials, nutrients, moisture, and proper temperature.

How Can I Avoid Mold?

To reduce the ability for mold to grow, you must reduce what constitutes its growth environment. Mold can grow with the smallest of a nutrient base. Just small amounts of dirt or dust on the carpet can be enough to allow the mold process to begin. Keep the environment as clean as possible. Vacuum the carpet. Clean food spills thoroughly and quickly. Avoid grease buildup near the stove or sink. Clean the exhaust fan above the stove often.

Minimize moisture in your motorhome and keep humidity low. Clean spills quickly. Do not allow condensation to build up. You can open windows and vents to minimize condensation.

Use of the air conditioner can assist in removing moisture from the air. Avoid leaks, but if leaks do occur, make repairs promptly.

Avoid bringing mold into your motorhome. Plants, cloths, books, and other household items may already have mold present. It is easy to transfer mold into your motorhome environment.

Monitor your motorhome. Periodically check those hidden areas in corners, closets, and cabinets to assure mold is not present.

What if I Find Mold?

If mold develops, clean the area with a concentrate of soap and bleach. Items that contain mold that cannot be cleaned should be removed from the vehicle.

Can Mold Harm Me?

The effects of mold and airborne mold spores may cause irritation to some people. Experts disagree on the level of exposure that may cause health concerns.

If Mold Is Present, What Will Winnebago Industries® Do?

If Winnebago Industries determines that mold is present in the Winnebago®/Itasca® motorhome as a result of a manufacturing defect reported to Winnebago Industries within the limited warranty period, Winnebago will clean the affected area(s) and/or replace affected items as it deems necessary. This is the extent of coverage provided by Winnebago Industries. Winnebago Industries, however, will not assume responsibility for mold deemed to be a result of a motorhome users lack of timely and appropriate action to mitigate circumstances should a problem occur.

If Winnebago Industries determines that mold is present due to conditions it determines is not a result of a manufacturing defect found within the warranty period, Winnebago Industries will not provide any financial assistance to the repair of the condition.

ROADSIDE EMERGENCY

Because of the size and weight of this vehicle and its tires, and the possible complications involved in tire changing, we strongly advise obtaining professional road service to change a flat tire whenever possible. However, if an emergency requires you to change the tire yourself, please exercise extreme caution and read all tire changing information in the chassis manual.

Never get beneath a vehicle that is held up by a jack only.

If You Get A Flat Tire

- DO NOT panic.
- Grip the steering wheel firmly and steer the vehicle as straight as possible. Avoid quick maneuvers. You may need to counter-steer to compensate for “pull” created by the failed tire.
- DO NOT stomp on the brake. This abruptly shifts the vehicle’s weight forward, making it nose-dive and pull toward the blown-out side.
- DO NOT jerk your foot off the accelerator. Just ease back on the accelerator slowly and gently to continue momentum. The deflated tire will slow the vehicle.
- If you must change lanes to get to a safe stopping place, use your signals to warn other motorists and change lanes smoothly and carefully after you are certain the lane is clear.
- Let the vehicle coast to a stop, gently steering to a safe stopping place off the traffic lanes of the road. Do not worry about damaging the tire or wheel rim by driving on it. A tire or wheel replacement is cheaper than damaging the vehicle or injuring yourself.
- When you have come to a stop, activate your hazard flashers to warn other motorists, then exit the vehicle carefully.
- Set out flares or other warning devices.

Check your tires for proper inflation before each trip and at least once a month with an accurate tire gauge.

Spare Tire Storage

If your coach is supplied with a spare tire, it will be located underneath the bed with access to the exterior of the coach or in an exterior storage compartment.

Recovery Towing

When calling a professional towing service, we recommend that you advise them of your coach length and approximate front axle weight listed on your Vehicle Certification Label. This will allow the towing operator to determine the proper towing equipment to use.

Winnebago Industries® does not assume responsibility for damage incurred while towing this vehicle.

NOTE: Consult your chassis manual for towing instructions or precautions provided by the chassis manufacturer.

NOTICE

Do not lift on bumper. Damage will result to front end body parts.

WARNING

Stay out from beneath the motorhome while it is suspended by the towing assembly. Do not allow passengers to occupy a towed vehicle. Death or serious injury can result.

JUMP STARTING

If your coach will not start from the chassis battery, try using the Battery Boost switch to divert power from the house batteries to the starter. (See “Battery Boost Switch” in *Section 3 - Driving Your Motor Home*).

If you wish to try jump starting the engine using another vehicle or booster system, see your chassis manual for connecting jumper cables to the automotive electrical system.

NOTICE

Do not attempt to push start this vehicle.
Damage to the transmission or other
parts of the vehicle will occur.

ENGINE OVERHEAT

If you see or hear steam escaping from the engine compartment or have any other reason to suspect an extreme engine overheating condition, pull the vehicle over to the roadside as soon as it is safe to do so, stop the engine, and get all passengers out of the vehicle.

NOTICE

Operating a vehicle under a severe
overheating condition can result in
damage to the vehicle.

For information on what to do in case of overheating, consult your chassis manual.

SECTION 3 - DRIVING YOUR MOTOR HOME

The information in this section refers only to features installed or adapted to the dash and driver compartment area by Winnebago Industries®. It also includes passenger seating in the living area of the coach.

Further Information

See the chassis manual in your InfoCase for all original chassis related controls, instrumentation, switches, and other features. This includes items such as transmission, parking brakes, cruise control, gauges, wipers, lights, etc.

SEATS – DRIVER/CO-PILOT

The driver and co-pilot seats may be independently adjusted to suit individual preference.

The seats may be swiveled to provide easy entrance and exit. The swivel feature also allows the seats on most models to be turned toward the living area for additional seating while the unit is parked.



WARNING

Assure seat is in its forward and locked position for travel. Do not adjust seat while vehicle is in motion. Failure to comply may result in injuries.

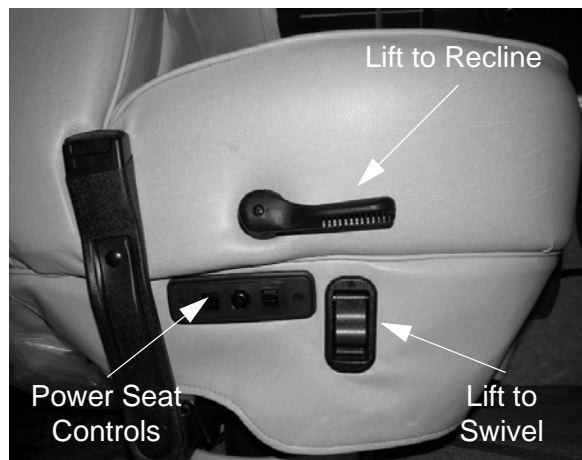

Driver Seat
-Typical View

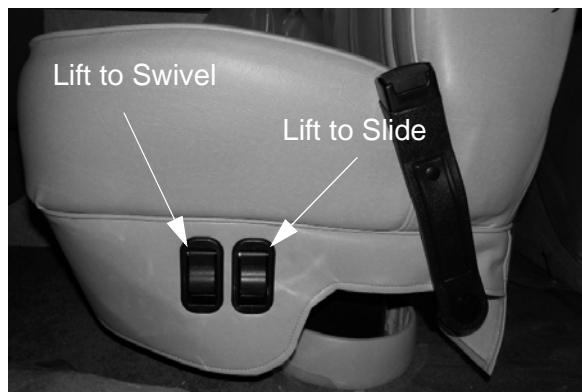

Passenger Seat
-Typical View

Multi-Adjustable Power Seat -If Equipped

The power seat controls are located on the lower right hand side of the driver seat base.

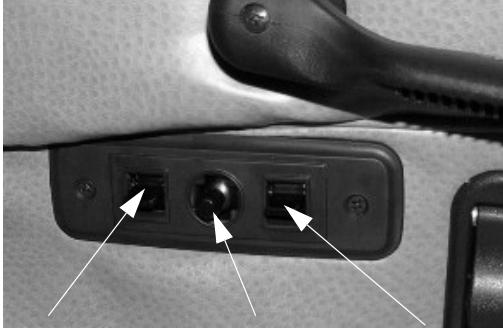

Hip Area
- Up/Down

Main Seat
Position
- Up/Down
- Fore/Aft

Knee Area
- Up/Down

To Face Driver Seat Rearward

Manual Seat

- Tilt the steering wheel all the way up.
- Put the left armrest down.
- Swivel the seat to the right until it just contacts the steering wheel, then slide the seat ahead all the way.
- Lift the recliner lever and let the seat back tilt ahead to clear the steering wheel.
- Swivel the seat the rest of the way to face the living area.
- Tilt the steering wheel down.
- Reverse the procedure to face the seat forward.

Power Seat

- Tilt the steering wheel all the way up and put the left armrest down.
- Move the seat rearward fully and then ahead a few inches.
- Swivel the seat to the right until it just contacts the steering wheel, then move the seat ahead all the way to clear the steering wheel.
- Swivel the seat the rest of the way to face the living area.
- Position the tilt wheel down and to provide maximum clearance to recline the seat.
- Reverse the procedure to face the seat forward.

Armrest Adjustment -If Equipped

The armrests may be swung upward out of the way for easy exit or access to the front seats. A roller on the underside of the front of the armrest also lets you adjust the resting angle for personal comfort, whether the seat is upright or reclined.



-Typical View

SEAT BELTS

Seats intended for occupancy while the vehicle is in motion are equipped with seat belts for the protection of the driver and passengers.

Lap Belts

The lap belts must be worn as low as possible and fit snugly across the hip area. Always sit erect and well back into the seat. To gain full protection of the safety belt, never let more than one person use the same safety belt at any one time, and do not let the safety belts become damaged by pinching them in the doors or in the seat mechanism. After any serious accident, any seat belts which were in use at the time must be inspected and replaced if necessary.

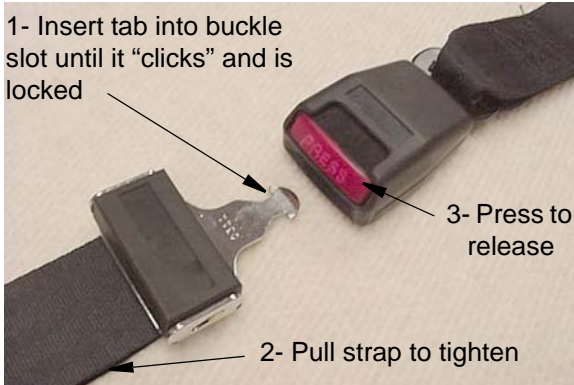

Adjustment

To lengthen belt, swivel the tab end at a right angle to belt and pull strap to desired length. To shorten, pull loose end of belt.

To Fasten

Be sure belt is not twisted. Grasp each part of the belt assembly and push tongue into buckle. Adjust to a snug fit by pulling the loose end away from the tongue.

To Release

Press button in center of buckle and slide tongue out of buckle.

 WARNING
Snug and low belt positions are essential. This will ensure that the force exerted by the lap belt in a collision is spread over the strong hip area and not across the abdomen, which could result in serious injury. Only seats equipped with seat belts are to be occupied while vehicle is in motion. Swivel seats must be in the locked, forward facing position while vehicle is in motion.

Lap/Shoulder Belts

Fastening

Hold the belt just behind the tongue. Next, bring the belt across the body and insert the tongue into the buckle until the latch engages.

Unfastening

Press the release button in the buckle. Hold onto the tongue when you release it from the buckle to keep it from retracting too rapidly.

When the lap-shoulder belt is in use, the lap belt must ride low across the hip area and the shoulder belt must ride diagonally over the shoulder toward the buckle.

The shoulder belt is designed to lock only during a sudden stop, sudden body movement or a collision. At all other times it will move freely with the occupant.

 WARNING
Never wear the shoulder belt in any position other than as stated above. Failure to do so could increase the chance or extent of injury in a collision.

Seat Belt Care and Cleaning

- Be careful not to damage the belt webbing and hardware. Take care not to pinch them in the seat or doors.
- Inspect the belts and hardware periodically. Check for cuts, frays, and loose parts. Damaged parts should be replaced. Do not remove or modify the belt system.
- Keep belts clean and dry. If the belts need cleaning, use only a mild soap and water solution. Do not use hot water. Do not use abrasive cleaners, bleach, or dyes. These products may weaken the belts.
- Replace any belt assembly that was used during a severe impact. Replace the complete assembly even if damage is not apparent.

CHILD RESTRAINTS

-If Equipped

A properly installed and secured child restraint system can help reduce the chance or severity of personal injury to a child in an accident or during a sudden maneuver. Children

SECTION 3 - DRIVING YOUR MOTOR HOME

may have a greater chance of being injured in an accident if they are seated in a child restraint system which is not properly secured.

A child restraint system is designed to be secured in a vehicle seat by a lap belt or the lap belt portion of a lap-shoulder belt.

When purchasing a child restraint system, follow these guidelines:

1. Look for the label certifying that it meets all applicable safety standards.
2. Make sure that it will attach to your vehicle and restrain your child securely and conveniently so that you are able to install it correctly each time it is used.
3. Be certain that it is appropriate for the child's height, weight, and development. The instructions and/or the regulation label attached to the restraint typically provides this information.
4. Review the instructions for installation and use of the restraint. Be sure that you understand them fully and can install the restraint properly and safely in your vehicle.

Tether Anchor Loop

-If Equipped

If your coach has a dinette, it may be equipped with a child seat tether anchor loop located on the floor directly behind the forward facing dinette seat.



The dinette table must be in the lowered position when a child seat is in use.



1. Lower the dinette table.
2. Route the tether over the top of the dinette seat back and hook it to the anchor loop on the floor.
3. Fasten the lap belt.

-Typical Installation

Model E35F

On Model E35F, the tether anchor loop is located behind an access opening underneath the dinette. Lower dinette table and remove dinette cushion and bench board to access.



See the child seat manufacturer's specific instructions for proper attachment and adjustment of the tether and seat belts.

KEYS

Your motorhome is supplied with several keys. In addition to the chassis manufacturer's ignition key, you receive keys for the entrance door and exterior compartment doors.

Keys have an identification number, either a small metal tag or stamped into the key head. These numbers are recorded on the vehicle's component model/serial sheet, which is included in your InfoCase. In case keys are lost or stolen, your dealer or a locksmith can provide you with duplicate keys or modify the locks.

REARVIEW MONITOR SYSTEM

-If Equipped



The rearview camera monitor system lets you see what is directly behind your coach for maneuvering assistance and safety.

A microphone built into the rear camera lets you hear warning sounds or verbal directions from an assistant.

Basic Operating Instructions



Power

- Turn ON to activate monitor for rear viewing while driving or parked. Key must be on.
- In OFF (Standby) position the monitor is "asleep" and will "wake up" when the transmission is shifted into reverse.

Menu

- Each one press less than 1 second enters brightness, contrast, color, or tint adjust mode. (Time out of menu is approximately 5 seconds from last key pressed.)
- Press menu button over 2 seconds to enter setup menu. (Press again before time out exits menu mode.)

Select

- Pressing the "Select" button sequences source input modes from Ch1, to Ch2, to Ch3.

Up/Down

- Pressing UP increases brightness, contrast, color, or tint level.
- Pressing DN decreases brightness, contrast, color, or tint level.

Day/Night

- Pressing DAY/NIGHT button sequences day/night backlight compensation through DAY, NIGHT, and AUTO modes.

Volume +/-

- Pressing "+" button increases speaker volume.
- Pressing "-" decreases speaker volume.

Sideview Cameras

-If Equipped

The optional sideview cameras allow you to see what is beside you before turning or changing lanes.

The sideview cameras activate with the corresponding turn signals and replace the rear camera view on the monitor until the turn is completed or the signal lever is canceled manually.

Further Information

See the rearview monitor manufacturer's complete operating information in your InfoCase.

**MIRRORS – POWER ELECTRIC
–If Equipped**

Always adjust mirrors for maximum rear visibility before driving off. Make sure the seat is adjusted for proper vehicle control and that you are sitting back squarely into the seat.

Mirror Adjustment Control

The mirror control is located on the driver side armrest panel or the dash. The ignition key must be on to adjust the mirrors.

Move Selector Switch L or R to select mirror. Center “neutral” position disables arrows to avoid unintentionally moving a mirror.

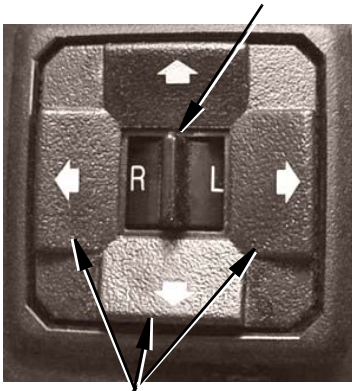

Press Arrow Buttons to move mirror surface in direction indicated.

Mirror Heaters

The mirrors may also contain heating elements to de-fog or de-ice the mirror glass during cold weather operation. A switch for the mirror heaters is located on the dash. To turn on, press the switch UP. Press DOWN to turn off.

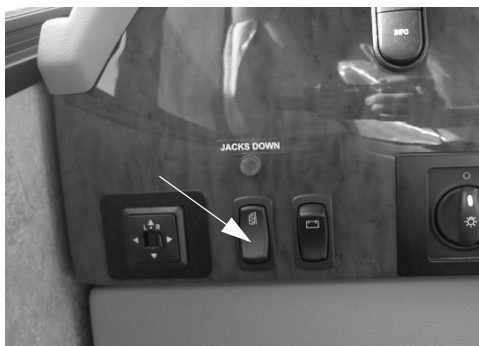

Mirror Heat Switch
(Located on dash)
-Typical View

Mirror Arm/Head Adjustment

If you cannot adjust a mirror properly using the control switch, the mirror may need a coarse adjustment by rotating the mirror head.



Mirror Head Pivot Lock

- Loosen Allen head set screws to pivot mirror head.
- Torque 75-100 in./lbs.

NOTE: Set screws may be located on the opposite side of the mirror arm. Passenger side mirror is similar.

BRAKE-SHIFT INTERLOCK

Ford® Chassis

The Brake-Shift Interlock is a safety feature that prevents the shift lever from being moved from the Park position unless the ignition is ON and the service brake pedal is pressed.

NOTE: If the brake light fuse is blown, the interlock feature will not work properly and an alternate method must be used. See the chassis manual provided in your InfoCase for detailed instructions on what to do in this situation.

PARK BRAKE – FOOT PEDAL

Ford® Chassis

The park brake foot pedal and release lever are located beneath the left side of the dash.

Step the pedal down fully to apply and pull the brake release knob to disengage.

TOW/HAUL TRANSMISSION MODE

Ford® Chassis only

This mode locks out Overdrive and helps reduce gear “hunting” by the automatic transmission while towing. It also improves power delivery and uses engine braking to help control vehicle speed when descending hills.

This mode may also be useful when the coach is fully loaded or when driving into a strong headwind.



- Press the button at the end of the shift lever to engage Tow/Haul Mode when pulling a trailer or tow vehicle

Further Information

See the chassis manual in your InfoCase for further operating instructions and cautions.

MAP LIGHT SWITCH

Turn the driver side map light on using the Panel Dim thumbwheel. Roll it up to maximum position until you feel it click into the map light “On” position.

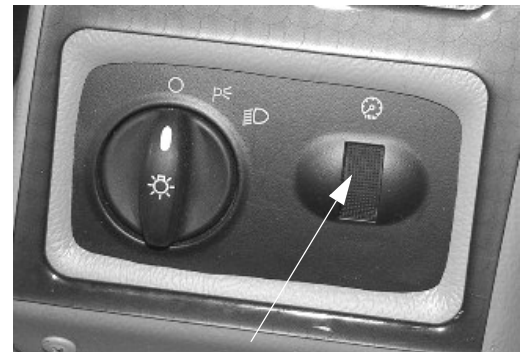

- Roll panel light dimmer wheel upward fully to turn driver side map light on

Further Information

See the chassis manual in your InfoCase for further information on this switch.

HAZARD WARNING FLASHERS

The hazard warning flashers provide additional safety when the vehicle must be stopped on the side of the roadway and presents a possible hazard to other motorists. When the flashers are on, it serves as a warning to other drivers.

Further Information

See your chassis manual for instructions on activating, operating, and canceling hazard warning flashers.

BATTERY BOOST SWITCH

This switch can be used to draw emergency starting power from the house batteries to start the engine if the chassis battery is discharged.

Press and hold in the UP position while turning ignition key for emergency starting power.

NOTE: The House/Coach Battery Disconnect switch near the entrance door must be ON and house batteries must be sufficiently charged for this feature to work.



Battery Boost Switch
(Located on dash)

**AIR CONDITIONER/HEATER -
AUTOMOTIVE (DASH)**

Controls for the air conditioner, heater, defroster, and vent are located on the dash.

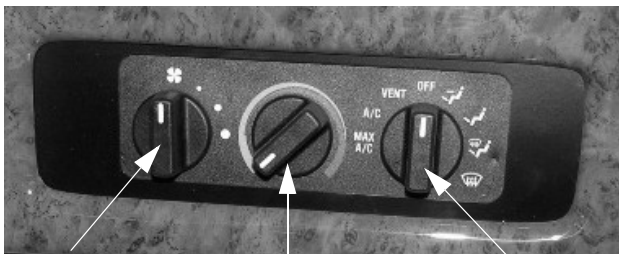

Blower
Control

Temp
Control

Mode
Selector

*NOTE: The dash air conditioner/heater is not designed to heat and cool the entire interior of the coach, but is intended only to provide heating and cooling for the cab area.
A small amount of air will blow out of all of the defrost and dash vents regardless of the mode setting.*

Further Information

See the manufacturer's user guide provided in your InfoCase for complete operating instructions.

**HEATER - REAR COACH
(AUTOMOTIVE)**

-If Equipped

To provide auxiliary automotive system heat to the rear of the vehicle while driving, turn the rear heater fan switch to the desired speed. The switch has three positions: High (up), Low (down), and the middle position is Off.



Coach Heat Switch
(Located on dash)

DEFROST FANS

- If Equipped

The two-speed auxiliary fans are intended to assist the automotive windshield defroster system in clearing fog and frost in cold weather or humid conditions.

- HIGH (up)
- LOW (down)
- The middle position on the switch is OFF.



Defrost Fan Switch
(Located on dash)

RADIO POWER SWITCH

The Radio Power switch lets you connect the dash radio to the coach batteries with the ignition switch turned off for listening while parked. This prevents accidental draining of the chassis battery with prolonged use of the radio.

NOTE: The House/Coach Battery Disconnect switch must be ON while listening to the dash radio because the audio relay is powered by house batteries. If the House/Coach Battery Disconnect switch is off, the speakers will not emit sound.



Radio Power Switch
(Located on dash)
-Typical View

- Press DOWN to run radio off of the house battery (the ignition key does NOT need to be turned on).
- Press UP to run radio off of the chassis battery.

RADIO – IN-DASH

-If Equipped



Further Information

Please refer to the manufacturer's operating guide in your InfoCase for detailed instructions on programming preset station buttons and using this system.

RADIO - IN-DASH

-If Equipped

The radio in your coach can receive AM/FM stereo. It is also a compact disc (CD) and DVD player for your listening enjoyment through quality high-output speakers located in several areas of the coach.



Futher Information

Please refer to the manufacturer's operating guide in your InfoCase for detailed instructions on programming preset station buttons and using this system.

CB RADIO POWER WIRING

Your coach is pre-wired for CB radio power connection. The wires are located beneath the dash to the left of the steering wheel.

Look for a pair of wires - yellow (+) and white (-) with connectors and flag labels suspended from the wiring harness.



CB Power Wires
(in plastic sheath)
Typical View - your coach may differ

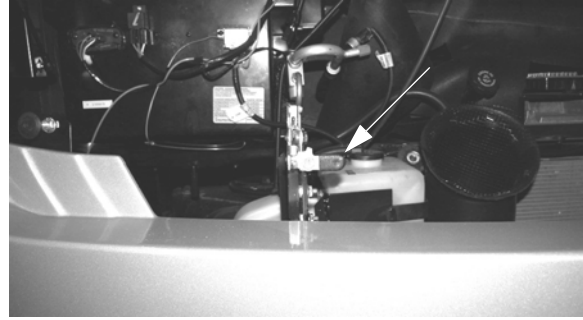

Front Hood Latch

FRONT SERVICE ACCESS (HOOD)

The hood panel can be opened for access to service items such as:

- Windshield Washer Fluid Reservoir
- Brake Fluid Reservoir
- Generator Oil Dipstick

Release the hood by lifting up on the latches (located on each side of interior hood), then pull the hood panel outward and raise it into the open position.



To close, pull hood down and push in with palms of hands on sides to secure latches. You will hear the hood latches “click” when engaged in the locked position.



(Lift up the latches on each side
of interior hood and raise)
-Typical View

ENGINE ACCESS - INTERIOR Front Engine Cover (Located between cab seats)

NOTE: Take precautions to protect carpet and interior furnishings when removing engine cover. The underside of the engine cover could contain deposits of oil and fuel or other engine fluids and substances that could damage fabrics and interior furnishings.

- **To remove the engine cover,** insert the supplied hex wrench into the hole (located on the top center **or** the front edge of the engine cover, depending on model).
- Turn the hex wrench to the left (counter-clockwise) to unlock.

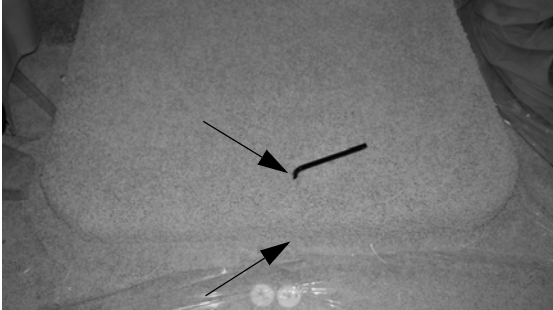

- Insert hex wrench into the hole located on the top center of the engine cover (as shown) or the front edge of engine cover (depending on model) to unlock.

-Typical installation shown

NOTE: On certain models, there may also be additional screws to remove at the lower front corners on each side of the engine cover. See following photo.



- Remove screws at the lower front corners on each side of the engine cover (if equipped).
-Typical installation shown
- Remove engine cover and set aside.



-Typical View

NOTE: If your coach is featured with a beverage tray, it may need to be removed to provide additional clearance before removing the engine cover.

If the beverage tray is equipped with a drawer, it must be removed to expose the fasteners that hold the tray to the engine cover.

- **To reinstall the engine cover**, position the front end of the cover first, then lower the rear end.
It is important to ensure the front edge is pushed completely forward to the radiator cover to ensure an air-tight seal.
- Press the rear end of the engine cover down and turn the hex wrench to the right (clockwise) until the latch pulls the cover downward and stops.
- Reinstall the screws at the lower front corners on each side of the engine cover (if equipped).

ENGINE COOLING SYSTEM

Do not remove the radiator cap while engine and radiator are still hot. Always check coolant level visually at the see-through coolant reservoir.

*NOTE: Your chassis engine cooling system is filled with special extended-life coolant that is not the same as common anti-freeze available at retail outlets. The coolant system **MUST** be refilled or topped up with the same type of coolant as equipped to maintain the special long-life properties.*

NOTICE

When refilling the coolant system of a vehicle equipped with a rear auxiliary automotive heater and motoraid water heater, be sure to allow for additional coolant capacity of the heater and its supply and return hoses.

Further Information

Refer to the chassis manual in your InfoCase for information and precautions on filling, servicing, and checking the fluid level.

**CHASSIS BATTERY
DISCONNECT SWITCH**

The Chassis Battery Disconnect switch disconnects most chassis electrical loads from the chassis (starting) batteries to avoid discharge by constant draws such as engine computers, radio clock, sensors, etc. (except the electric entrance step). This feature is intended to help conserve battery charge during storage.



Chassis Battery Disconnect Switch
(Located near entrance door)
-Typical View

NOTE: The Chassis Battery Disconnect switch must be ON to start the engine.

TIRES

Improper tire pressure can result in tire overloading and abnormal wear and also affects handling, ride characteristics, and fuel economy.

 WARNING
Make sure all replacement tires are of the same size and rating as those shown on your Vehicle Certification Label.

**SUSPENSION ALIGNMENT
AND TIRE BALANCE**

The front suspension and steering system of this vehicle was factory aligned using highly accurate equipment prior to delivery to the dealership. However, alignment should be checked and adjusted after you have fully loaded the motorhome according to your personal needs. Thereafter, the alignment should be periodically inspected to help prevent uneven tire wear.

Any excessive or abnormal tire wear may indicate worn or misaligned suspension or steering, unbalanced tire, or other tire/suspension problem.

Alignment can be affected by worn steering/suspension parts or by incidents which happen during driving, such as hitting a curb, pothole, or railroad track, etc. Improper alignment can cause tires to roll at an angle and wear unevenly. It may also cause the vehicle to “pull” to the right or left. Have your dealer inspect your vehicle’s suspension and steering components periodically for misalignment or wear.

Out-of-balance tires will not roll smoothly and can lead to vibrations and uneven tread wear, such as cupping and flat spots. Tires may need to be balanced if uneven wear is detected or if ride comfort decreases noticeably.

Further Information

See the chassis manual in your InfoCase for further information.

LIGHTS

All exterior lights should be checked for proper operation each time the vehicle is prepared for a trip. Any bulbs which fail to light should be checked and replaced, when necessary, with a new bulb of the same size. A failure of more than one light, such as both taillights not operating, may indicate a burned out fuse. Check fuse and replace with one of the same rating when necessary. If a fuse is not the cause of the problem, the wiring system should be checked immediately by an authorized service center.

Further Information

Refer to the chassis manual in your InfoCase for further information.

CIRCUIT BREAKERS AND FUSES - CHASSIS/DASH AUTOMOTIVE 12-VOLT

The 12-Volt Automotive Fuses and Circuit Breakers are conveniently located beneath the left end of the dash in front of the driver seat. Remove cover to access.

The circuit breakers will pop outward if they are tripped. Simply push in to reset. Always replace plug-in blade fuses with ones of the same size and amperage rating/color.



Automotive 12-Volt
Circuit Breakers and Fuses
(Located beneath left end of dash)
-Typical View



SECTION 4 - APPLIANCES AND SYSTEMS

The appliances installed in your motorhome are manufactured by reputable RV appliance makers and have been tested by independent laboratories to meet all applicable standards and codes set for RV appliances.

See *Section 2 - Safety and Precautions* of this manual for any safety and precautions you need to take regarding the operation of your appliances.

REFRIGERATOR

The refrigerator in your coach can operate from either of two energy sources available to the motorhome:

- 120-Volt AC Electric
- Propane Gas

To be able to use both types of energy, the refrigerator does not have a compressor like household refrigerators. Instead, it uses an ammonia-water solution for cooling. Basically, ammonia vapor is distilled from the solution by heat produced from either propane gas flame or electrical heat element. The ammonia vapor is then carried to the finned condenser where it liquefies. The liquid then flows to an evaporator where it creates cooling by evaporation. The ammonia circulates back into the water solution and the cooling cycle continues.

Leveling

Before operating the refrigerator when the motorhome is stationary, place a small level on the bottom of the refrigerator and make certain the unit is level. If over 1/2 of the bubble is inside the circle in any direction, the coach is level enough for continuous operation of the refrigerator while parked.



Place bubble level in bottom of refrigerator

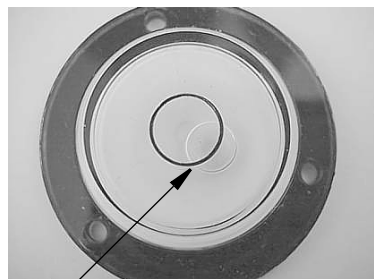

Bubble must be at least 1/2 inside circle

Normal vehicle leveling to provide comfort for the occupants is satisfactory for refrigerator operation.

NOTICE

To prevent permanent damage to the refrigerator cooling unit, turn the refrigerator off if the vehicle will be parked on an incline of over 3° side-to-side or 6° front-to-rear (such as steep driveways or parking lots, etc.) for more than one hour.

Basic Operation

Slide the control switches to the operating positions described and observe the indicator lights.



- **Gas-** Refrigerator will operate on gas from the propane tank if the main valve is open and the tank contains gas.
- **Auto-** Refrigerator will operate on 120-VAC household current if the shoreline is connected or the auxiliary generator is running. If electricity is lost, it will automatically switch over to Gas operation if gas is available.
- **Temperature Setting-** Start at the coldest setting to ensure coldest temperature in the freezer compartment, then adjust warmer as necessary after cold* food has been added.
- **“On” Indicator Light-** Glows steady when refrigerator is operating properly.
- **“Gas” Indicator Light-** Will flash if gas is not available. To operate the refrigerator you must provide 120VAC then switch to Auto operation.

* *The refrigerator will retain temperature more efficiently if food is cold before placing inside.*

Further Information

For further information and operating cautions, see the refrigerator operating instructions included in your InfoCase.

REFRIGERATOR SERVICE ACCESS COMPARTMENT (Exterior)

The exterior refrigerator service compartment allows access to the rear of the refrigerator for inspection, maintenance, and service.

To Open

1. Use a screwdriver or coin to turn the latch knobs to the vertical position as shown.



Refrigerator Access Door Latches

2. Remove the door from the opening.

To Close

1. Replace the door into the opening.
2. Push the latch knobs in while turning to the horizontal position as shown.

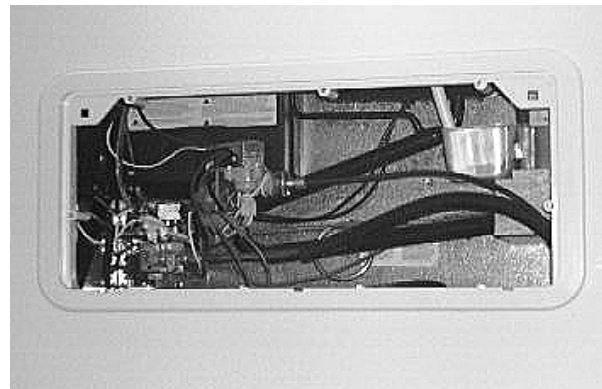

Refrigerator Access Compartment

RANGE AND OVEN

-If Equipped

The Range and optional Oven in your motorhome operate on propane gas and will provide most of the functions of the range in your home.



To Light Range Top Burners

- Turn the desired burner knob counter-clockwise to the ON or LITE position (do NOT attempt to light more than one burner at a time).
- Turn the SPARK knob clockwise one “click”.

NOTE: If the burner fails to light, continue turning the SPARK knob clockwise until the burner lights.

- To extinguish the burner flame, turn desired burner knob clockwise to OFF.

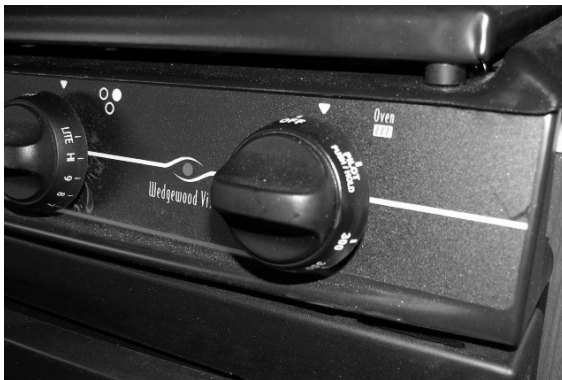

Oven Burner Knob -If Equipped

- PILOT ON position keeps pilot flame lit for repeated use of Oven while vehicle is parked.
- Turn Oven knob to PILOT OFF position while traveling or refilling propane gas tank.

To Light Oven Pilot

- See “Oven Operation” in the manufacturer’s user guide provided in your InfoCase.

Avoiding Asphyxiation

The following warning label has been located in the cooking area to remind you to provide an adequate supply of fresh air for combustion.

WARNING

IT IS NOT SAFE TO USE COOKING APPLIANCES FOR COMFORT HEATING. Cooking appliances need fresh air for safe operation. Before operation:

1. Open overhead vent or turn on exhaust fan.
2. Open window.

FAILURE TO COMPLY COULD RESULT IN DEATH OR SERIOUS INJURY

Unlike homes, the amount of oxygen supply is limited due to the size of the recreational vehicle, and proper ventilation when using the cooking appliances avoids dangers of asphyxiation.

It is especially important that cooking appliances not be used for comfort heating, as the danger of asphyxiation is greater when the appliance is used for long periods of time.

FAILURE TO COMPLY COULD RESULT IN DEATH OR SERIOUS INJURY.

WARNING

Portable fuel-burning equipment including wood and charcoal grills and stoves, shall not be used inside the recreational vehicle. The use of this equipment inside the recreational vehicle can cause fires or asphyxiation. Failure to comply could result in death or serious injury.

Further Information

See the appliance manufacturer’s user guide provided your InfoCase for complete operating instructions and safety precautions.

MICROWAVE OVEN

-If Equipped

Refer to the manufacturer's user guide located inside the appliance for complete operating instructions.



Microwave Oven - Typical
(brand, model, and appearance
shown may vary from your model)

**MICROWAVE OVEN/RANGE
HOOD**

-If Equipped

The range hood vent is built into the microwave oven. The range hood fan carries cooking odors and gas fumes to the outside of the coach. A light on the underside of the hood provides illumination for food preparation. The hood fan and light switches are located on the microwave control panel.



Microwave Oven/Range Hood
(Brand, model, and appearance
shown may vary from your model)
-Typical View

Further Information

See the manufacturer's user guide provided inside the appliance for complete operating instructions and replacement of vent hood light bulbs and replacement or cleaning of grease filter elements.

RANGE HOOD

-If Equipped

The range hood vent draws cooking odors and airborne grease particles into the filtration grid and either recirculates the air or vents it to the outside of the coach, depending on model.

A light on the underside of the hood provides illumination for cooking and food preparation.

Further Information

See the manufacturer's user guide provided in your InfoCase for instructions on replacement of light bulbs and replacement or cleaning of grease filter elements.

SYSTEMS MONITOR PANEL

The Systems Monitor Panel provides a convenient central location for checking the condition of all utility systems in your coach.



At the touch of a button, this panel will display the fresh water and holding tank levels, propane gas tank level, plus the house battery condition. You can start the generator or turn on the water

pump and water heater. Indicator lights tell you if the water pump is on or if the water heater pilot light is out.

Water And Holding Tank Levels

Press and Hold the “Levels Test” switch to show approximate level on the monitor lights.



The approximate fluid levels are measured by electronic sensors on the sides of the tanks. There is generally more fluid in a tank than indicated on the monitor panel.

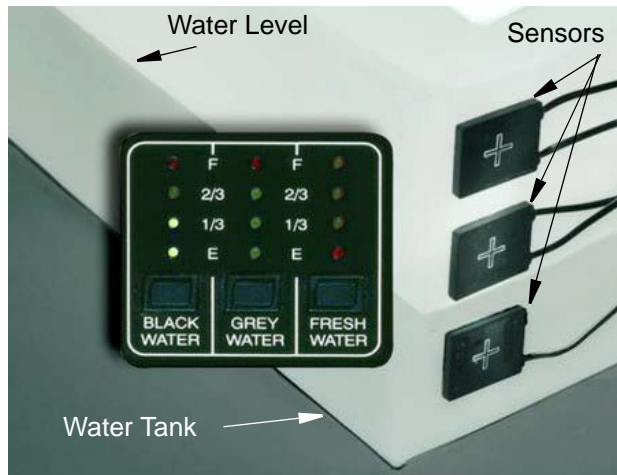

For example, if the fluid level is 1-2” below the FULL sensor, the monitor will show the level to be only 2/3 even though the tank is nearly full.

If a tank is about 1/4 full, the monitor will register an empty tank because the fluid level is below the 1/3 sensor even though there is still fluid in the tank.

However, when the indicator reads FULL, the tank is actually full.

Black and Gray Waste Level Selector Switches

(Models 35B and 35F only)

These models are equipped with multiple black and gray water holding tanks. Because the monitor panel can display only one black and gray water tank level at a time, a selector switch is provided.

Model 35B

(Equipped with Black and Gray Waste Level Selector Switches)

Press either the Black or Gray Waste Level Selector switch to select the desired tank level to be displayed on the monitor panel.



Black and Gray Waste Level Selector Switches
(Located near monitor panel)

Model 35F

(Equipped with Black Waste Level Selector Switch)

Press the Black Waste Level Selector switch to select the desired black tank level (front or rear) to be displayed on the monitor panel.



Black Waste Level Selector Switch
(Located near monitor panel)

Tank Capacities

See “Tank Capacities” in *Section 1 - Introduction*.

Propane Gas Level

Press and Hold the “Levels Test” switch to show approximate propane tank level.

The propane level is registered by a sending unit on the tank. The gauge mounted on the side of the tank will give a more accurate indication of actual tank level if needed.

Battery Charge Meter

Press and Hold the “Levels Test” switch to check the level of charge (voltage) in the 12-volt house battery.

The colored segments (red, yellow, and green) will light from the bottom up to the amount of charge the battery contains.

- Green - good or adequate charge.
- Yellow - marginal charge.
- Red - battery needs charging before use.

To get an accurate reading:

1. Both the chassis engine and the generator engine must be shut off and 120-volt AC shoreline unplugged.
2. An interior light should be turned on to provide a small load which draws off the battery surface charge.

Water Pump Switch

When use of the self-contained water system is desired, turn the “Water Pump” switch on. The “Pump On” light will illuminate when the pump switch is on and the system is operable. Water will be available as soon as a faucet is opened. Refer to “Water Pump” for additional information on the water pump and initial start-up.



NOTE: Some models may be equipped with a Water Pump switch in the water service center on the outside of the coach or within the bathroom area for your convenience.

**POWER CONTROL SYSTEM
(PCS)**

-If Equipped

The Power Control System (PCS) monitors the electrical usage of the appliances and equipment in the coach and allows you to use certain high energy appliances, such as the microwave or washer/dryer, without overloading the shoreline circuit breaker to help prevent nuisance tripping.



**PCS Display Panel
(Located near monitor panel)
-Typical View**

Further Information

Refer to the manufacturer's user guide provided in your InfoCase for important information on how this system operates under several conditions, whether 20-amp, 30-amp, and 50-amp connections, or generator service.

NOTE: In 50-amp service, the load meter is blank. In all other conditions, the load meter displays actual current load.

WATER HEATER – GAS

NOTE: Read the Water Heater operating guide provided in your InfoCase for complete operating instructions, safety warnings, and maintenance information before operating the Water Heater.

Ensure the Water Heater is filled with water before operating.

To fill the Water Heater, turn the Water Pump switch ON and open a hot water faucet anywhere in the coach. When water begins to flow steadily from the faucet, the Water Heater is full.

Propane Gas Operation

- Press the Water Heater switch (located on the Systems Monitor Panel) to the ON position.



- The “Pilot Out” light will glow for about 10-15 seconds, then it will go out. The “Heater On” indicator will remain lit.
- If the “Pilot Out” light comes on during operation, it means that the burner has gone into “lockout” mode and must be restarted. If

this happens, turn the Water Heater switch OFF for approximately 5 minutes, then turn back on.

WATER HEATER - GAS/ ELECTRIC

–If Equipped (with Motoraid water heating system)

The gas/electric water heater has a dual power feature. It can operate from propane gas or 120-volt house current; or it can use both at the same time for quicker recovery at times when you are using a lot of hot water.

Read the Water Heater Operation Manual for complete Safety Warnings, Operating Instructions and Maintenance Information before operating the water heater.

Be sure the water heater is filled with water before starting either electric or propane gas operation. To fill the water heater, turn the Water Pump switch on and open a hot water faucet anywhere in the coach. When water begins to flow steadily from the faucet, the water heater is full.

For Propane Gas Operation

Press the Water Heater switch on the Monitor Panel. The “Pilot Out” light will glow for about 10-15 seconds, then it will go out. The “Heater On” indicator will remain lit. If the “Pilot Out” light comes on during gas operation, it means that the burner has gone into “lockout” mode and must be restarted. If this happens, turn the Water Heater switch off for about 5 minutes, then turn it back on.

See the water heater user's guide in your InfoCase for further information.



Gas Water Heater Switch
(Located on Systems
Monitor Panel)

For Electric Operation

Turn on the Water Heater electric element switch. The shoreline must be connected or generator running for electric operation.



Electric Water Heater Switch
(Located near monitor panel)

For Quick Recovery Operation (Dual Heating)

Turn On both Water Heater switches - the gas one on the monitor panel and the electric one. This will help reheat the water heater tank more quickly than a single source would alone. Use this mode when you are using a larger than normal volume of hot water.

Further Information

Read the operating and safety information provided in the Water Heater Operation Manual in your InfoCase.

MOTORAID WATER HEATER

-If Equipped

The Motoraid uses heat from the chassis engine cooling system to heat water in the water heater while driving. Hoses are routed from the engine to a heat exchanger surrounding the water heater tank.

Under normal conditions, the entire contents of the water heater can be heated in about two hours or 100 miles of driving. This means you can have hot water at the faucets immediately upon arriving at a site.

The Motoraid also increases the capacity of the engine cooling system.

NOTICE

Any leak in the heat exchanger or its supply or return lines could cause loss of coolant and subsequent engine failure. We recommend that you periodically inspect these connecting lines and the heater to insure that no leaks have developed.

PRESSURE-TEMPERATURE RELIEF VALVE

On occasion, water may be seen seeping from the water heater pressure temperature relief valve. This is no cause for repair or replacement of the valve.

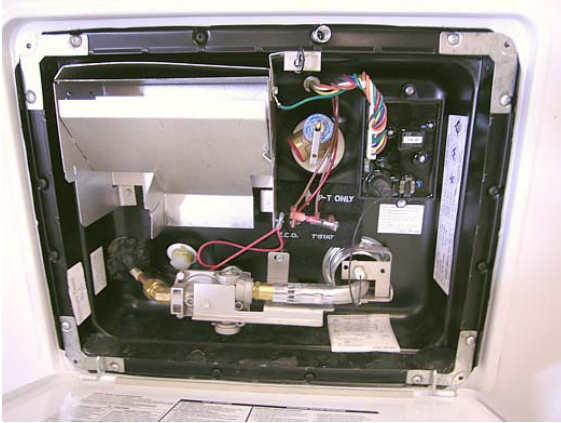

Water Heater Exterior Service Access

Normally there is an air gap at the top of the water heater tank, which acts as a pressure buffer. In time, however, heated water may expand and fill this air gap, causing a slight increase in water pressure. This may cause the P-T valve to “weep” until the air gap is manually replaced.

CAUTION

Hot water can escape from tank causing injury. Operate this valve only when the water heater and engine cooling system are cold.

To Replace the Air Gap:

1. Turn off the Water Heater switch and incoming water supply (city water and/or demand pump).
2. Open a faucet in the motorhome to relieve water pressure.
3. Pull the handle of the P-T valve straight out and allow water to flow until it stops.

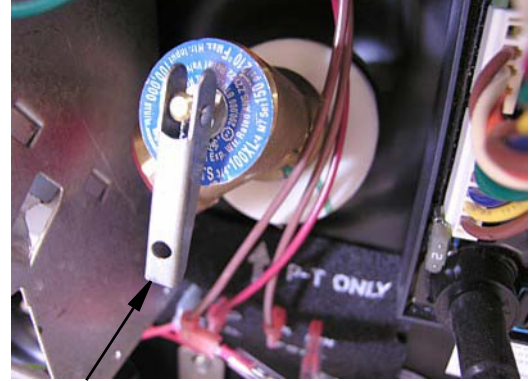

- Lift handle straight out to open P-T valve when water heater is cold

4. Let the handle of the P-T valve snap shut.
5. Close the faucet and turn on the water supply before switching the water heater on.

Manually operate the pressure temperature relief valve at least once a year.

NOTE: If your water heater is equipped with the motoraid system, it uses an extension from the engine cooling system to heat water in the water heater while driving. The engine cooling system must also be cold before opening the pressure-temperature relief valve. See “Motoraid Water Heater” for more information.

PROPANE GAS FURNACE

To Start Up

1. Open the Propane Gas Tank valve by turning fully “counter-clockwise”.



Thermostat Switch

- Move to Heat or Gas position for furnace operation

Temp Selector

- Press up or down to select temperature

-Typical View

2. Slide the Thermostat switch from Off to Heat and press the Temp Selector button (up/down arrows) until the desired temperature is shown on the display.
3. The furnace fan should start to blow immediately after setting the thermostat.
4. After approximately 30 seconds, the furnace burner should light.
5. The furnace should now cycle off and on automatically as the thermostat demands just like a household furnace.

NOTE: If heat does not come out of the heat ducts after a minute or so, the burner is not lit.

Turn the thermostat off for 3-5 minutes, ensure Propane Gas Tank valve is open and tank is not empty, then repeat Steps 2-4.

If the furnace will not light after three attempts, go to “Shut Down” steps and contact your dealer or a local RV service center for repair.

To Shut Down

1. Slide Thermostat switch to the Off position.
2. Close propane tank valve if coach will be stored for a period of time.

Further Information

Refer to the manufacturer’s user guide provided in your InfoCase for further information, including operating precautions, and periodic maintenance. See “Coach Maintenance Chart” in *Section 11 - Maintenance and Storage* for recommended intervals.

NOTE: If the furnace burner has any residuals of metal protectant or lubricants used during manufacture of the furnace, it may smoke slightly when the furnace is used for the first time and may set off your smoke alarm.

We recommend that you provide adequate ventilation when using the furnace for the first time to avoid a nuisance smoke alarm.

We do not recommend removing the smoke alarm battery.

HEAT PUMP

-If Equipped

Your coach may be equipped with an air source Heat Pump built into the air conditioning system. Because the Heat Pump operates on electricity, it provides economical heat inside your coach and helps reduce the use of propane gas for heating in cooler weather.

A Heat Pump can be thought of as an air conditioner running in reverse. An air conditioner absorbs heat from the air on the inside of the coach and moves it to the outside. The Heat Pump does exactly the opposite. Even cold air contains some heat, so a Heat Pump will extract heat from the outside air on a cold day and carry it to the inside of the coach to maintain a comfortable temperature.

The efficiency of a Heat Pump decreases as the outdoor air temperature drops, so supplementary heat is often needed when the outside temperature nears freezing. This system is set to automatically start the propane furnace to assist the Heat Pump if room temperature cools to five degrees or more below the thermostat set temperature. You may wish to manually switch to furnace heat to maintain a higher temperature

when outside temperatures begin to reduce the efficiency of the Heat Pump. The Heat Pump will not operate when the outside temperature falls below 36 degrees F.

To Operate the Heat Pump

Refer to the manufacturer's user guide provided in your InfoCase for complete operating instructions.



- Gas Heat = Propane Furnace
- **Elec Heat = Heat Pump**
- Cool = Roof Air Conditioner

-Typical View

Check Your Air Filter

Closed or blocked vents and a dirty air filter can hinder the efficiency of a Heat Pump.

- Ensure ceiling vents are open to distribute Heat Pump output air.
- The A/C return air filter should be checked monthly for dirt build-up and cleaned or replaced as needed. See "Air Conditioner Filter" elsewhere in this section.

DUCTED ROOF AIR CONDITIONING SYSTEM

The furnace thermostat also controls ducted roof air conditioner operation when the Thermostat switch is placed in "Cool" position.

All cooling functions controlling to setpoint have a short cycle protection time delay of three minutes. There will be no delay if the cycle OFF time exceeds three minutes.

NOTE: The ducted roof air conditioning system has ceiling registers that can be closed if necessary to force more cool air toward a specific area of the coach or to route cool air away from a specific area. If too many vents are closed, however, it can cause the air conditioner unit to shut down, particularly in high humidity conditions.

Further Information

Refer to the manufacturer's user guide provided in your InfoCase for complete operating instructions.

AIR CONDITIONER FILTER

The washable foam air conditioner filter is located in the ceiling-mounted return A/C grille in the lounge area of the coach.

It is recommended to check the filter monthly for dirt build-up and cleaned or replaced, as necessary.

REAR AIR CONDITIONER POWER SELECTOR SWITCH

-If Equipped

(models with 2 roof air units and 30-amp service only)

If you want to run the rear AC unit, you must switch the Rear A/C Selector switch to the proper power source.



- If you are using the shoreline, the switch must be in POWERCORD position.

SECTION 4 - APPLIANCES AND SYSTEMS

Chalet

- If you are using the generator, the switch must be in GENERATOR position.

The rear air conditioner may not operate properly if the switch is not in the proper position for the power source being used.

NOTE: The power cord must be plugged into the generator receptacle for generator operation.

Chalet

SECTION 5 - PROPANE GAS

PROPANE GAS SUPPLY

The propane gas system supplies fuel for the gas range/oven, water heater, furnace, and refrigerator (while in gas mode). When used and handled properly, this system is safe and economical and provides modern living conveniences wherever you travel.

See *Section 2 - Safety and Precautions* in this manual for other safety and precautions you need to be aware of related to propane.

How Propane Gas Works

Propane is a type of LP (Liquefied Petroleum) gas compressed into liquid form for easy transportation and storage. Propane gas may also be called tank gas, bottle gas, or simply LP.

Propane is used by appliances in vapor form only, but is stored in the tank as a liquid under very high pressure. As the liquid gas is released, it reverts back to a vapor and expands to many times its compressed volume.

Propane Tank System

The storage reservoir for the propane gas system is a horizontally mounted tank which is permanently attached to the vehicle frame. The tank is accessible only from the outside of the vehicle.

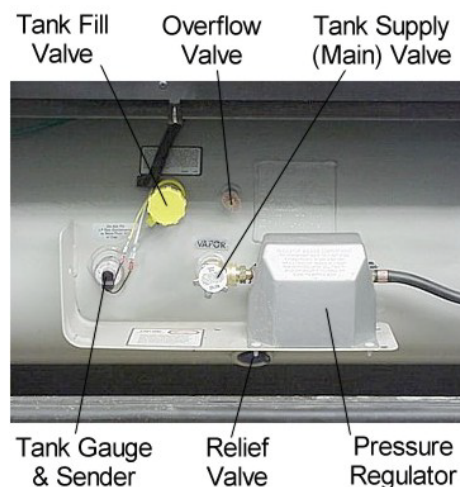

Propane Tank Features
-Typical View



WARNING

Do not alter or remove propane tank valves or gauge. Propane can escape, which can cause an explosion resulting in death or serious injury. Have the propane system serviced by a qualified service center.

Refilling Propane Tank

Since the propane tank is permanently mounted to the frame, the motorhome must be taken to a propane dealership for filling. Do not attempt to remove the propane tank from the vehicle. The tank is equipped with a fill adapter with both internal and external threads, which allows easy filling with any propane filling equipment. The tank is full when liquid propane gas appears at the overflow valve.

NOTE: The propane tank is equipped with an automatic 80% stop-fill device.

 **DANGER**

DO NOT FILL CONTAINER TO MORE THAN 80 PERCENT OF CAPACITY. FAILURE TO COMPLY COULD RESULT IN A FIRE OR PERSONAL INJURY.

Make sure the motorhome is level when filling. It is possible to accidentally overfill the tank if the vehicle is not level, with the fill valve on the uphill side. Overfilling the propane gas tank can result in uncontrolled gas flow, which can cause fire or explosion. A properly filled container will contain approximately 80 percent of its volume as liquid propane gas.

All pilot lights must be extinguished and appliances and their ignitors turned off, and supply valve closed before refilling propane gas tanks or vehicle fuel tanks.

Do not smoke or expose an open flame while near a propane refueling area. Propane gas is heavier-than-air and extremely flammable.

Never fill the propane tank with engine or generator running.

Before opening the supply valve, check to be sure all controls for gas appliances are in the "Off" or "Pilot Off" position. If this step is not performed, propane gas could accumulate inside the motorhome creating a fire or explosion hazard.

Never use an open flame to test for propane gas leaks.

Replace all protective covers and caps on propane system before filling.

Selecting Propane Fuel Types

We recommend using straight propane in your propane tank. Propane gas is commonly available at all propane gas outlets in the U.S. (According to the National Propane Gas Association, propane gas outlets in the United States do not offer any other type of liquefied petroleum gas than propane to the general public.) Check local

phone directory yellow pages for locations of local propane gas refilling stations or bulk dealerships.

NOTE: If you travel outside the U.S. with your motorhome, you may find butane or propane/butane mixtures available in addition to propane. Because gas-burning RV appliances are designed to run on propane only, we recommend that you request straight propane only. Butane burns about 30 percent hotter than propane and can overheat some appliances, particularly refrigerators, and cause permanent damage. Other appliances designed to operate on propane can become sooted and lose efficiency by using butane fuel.

Air in the Propane Gas Tank

If your gas appliances do not stay lit or require frequent adjustment, even though you know the propane tank contains sufficient fuel, the problem may be air in the propane gas tank. Air in the tank mixes with the propane gas vapors causing them to burn poorly. This condition could linger for weeks if the air is not purged from the tank. Most propane gas dealers have equipment for purging air from propane gas tanks and will purge before refilling the tank.

SAFE USE OF THE PROPANE GAS SYSTEM

The propane system is designed and built with strict adherence to national, state, and recreational vehicle industry requirements for mobile propane gas equipment.

For your safety, there are many safety devices and backup systems installed, such as tank fill overflow valves, an interior propane gas detector/ alarm, and an interior carbon monoxide (CO) detector/alarm.

Propane gas also contains an odor additive that you can smell if propane is present in the air.

Here are a few precautions to observe that will help you to use the propane gas system safely:

- Exercise caution at all times. Be familiar with the distinctive odor of propane gas. If a leak is suspected, turn off the supply valve immediately. Have the propane gas system checked by your dealer or other qualified propane gas service center.
- Do not tamper with the propane gas piping system, pressure regulator, or gas appliances. Service and maintenance of propane gas system components should be performed only by your dealer or a qualified propane gas service center.
- Never attempt to connect natural gas to the propane gas system.
- Have the entire propane gas system inspected for possible leaks and missing or damaged parts at each tank filling. Also inspect before and after each trip, and any time trouble is suspected.
- Turn the propane supply valve off when not using the propane gas system.
- Never use a wrench to tighten the tank supply valve. It is designed to close leak-tight by hand. If a wrench is required to completely close the valve, it is defective and must be replaced.
- Be sure appliance and outside vents are open and free from obstruction when using the propane gas system.
- Never attach a lock or any device requiring a key to the propane tank compartment door. According to standards set for recreation vehicles, the propane supply valve must be readily accessible in an emergency.
- Exercise caution when drilling holes or attaching objects to the walls. Gas lines and electrical wiring could be seriously damaged and present an extreme safety hazard.

PROPANE GAS WARNINGS AND PRECAUTIONS

It is illegal for vehicles equipped with propane tanks to travel on certain roadways or through certain tunnels in the U.S. To avoid inconvenience, check state regulations concerning flammable gas transportation.

Propane Gas Leaks

The following label is located in the vehicle near the range area. If you smell gas within the vehicle, quickly and carefully perform the procedures listed.

 **DANGER**

IF YOU SMELL PROPANE

1. EXTINGUISH ANY OPEN FLAME, PILOT LIGHTS, AND ALL SMOKING MATERIALS.
2. DO NOT TOUCH ELECTRICAL SWITCHES.
3. SHUT OFF THE PROPANE SUPPLY AT THE TANK VALVE(S) OR PROPANE SUPPLY CONNECTIONS.
4. OPEN DOORS AND OTHER VENTILATING OPENINGS.
5. LEAVE THE AREA UNTIL THE ODOR CLEARS.
6. HAVE THE PROPANE SYSTEM CHECKED AND LEAKAGE SOURCE CORRECTED BEFORE USING SYSTEM AGAIN.

FAILURE TO COMPLY COULD RESULT IN
EXPLOSION RESULTING IN DEATH OR
SERIOUS INJURY

- All pilot lights must be extinguished and appliances and their ignitors turned off while refilling the fuel tank or propane tank.
- Never smoke while refilling vehicle fuel tank or propane gas tank.
- Avoid inhaling exhaust gases produced by burned gasoline, diesel fuel, or propane gas in items such as the range, chassis engine, generator engine, refrigerator, furnace, and water heater. They contain carbon monoxide, which is an odorless, colorless, and poisonous gas.

⚠ WARNING

Propane cylinders shall not be placed or stored inside the vehicle. Propane cylinders are equipped with safety devices that relieve pressure by discharging propane to the atmosphere. Failure to comply could result in death or serious injury.

- Never use an open flame to test for propane gas leaks. Replace all protective covers and caps on propane system after filling. Make sure valve is closed and door latched securely.
- Portable fuel-burning equipment, including wood and charcoal grills and stoves, shall not be used inside the recreational vehicle. The use of this equipment inside the recreational vehicle may cause fires or asphyxiation.
- Regulators are equipped with a protective cover. Make sure that the regulator vent faces downward and that the cover is kept in place to minimize vent blockage, which could result in excessive gas pressure causing fire or explosion.

⚠ WARNING

Visually inspect the pressure regulator vent periodically for blockage by accumulated debris or insect nests, etc. Vent obstruction could result in excessive pressure causing fire or explosion, which could result in death or serious injury. If an obstruction exists, have the regulator serviced by a qualified service center.

NOTE: If your model is equipped with a propane powered electrical generator, there will be two regulators stacked one upon another. One regulates the house propane supply pressure, the other regulates pressure to the generator.



**PROPANE GAS PRESSURE
REGULATOR**

The pressure regulator is protected from the elements by a plastic cover, which should be left in place at all times.

Propane regulators must always be installed with the regulator vents facing downward. Regulators that are not in compartments have been equipped with a protective cover. Make sure that the regulator vent faces downward and that the cover is kept in place to minimize vent blockage that could result in excessive propane pressure causing fire or explosion.

Only your dealer or a qualified propane gas service should remove the regulator cover for adjustments.

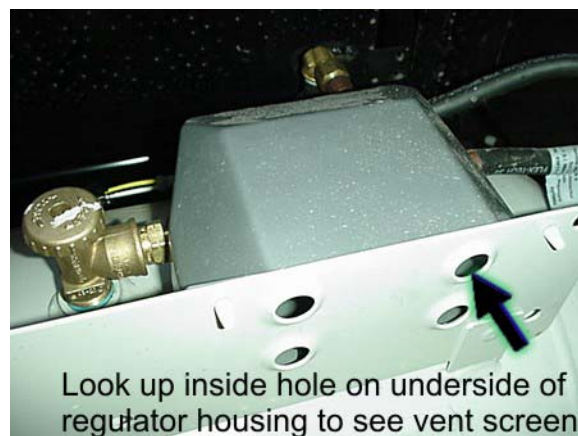

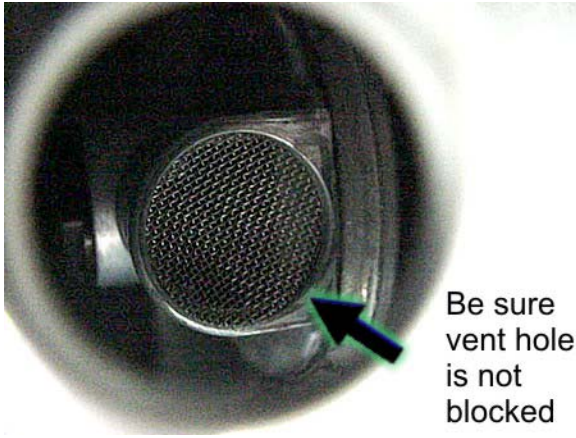

Regulator Freeze-up

Regulator freeze-ups are caused by the presence of moisture in fuel. This moisture will pass through the cylinder valve and into the regulator where it can freeze. Fuel producers, tank and bottle manufacturers, and propane gas dealers take every precaution to reduce moisture, but sometimes only a fraction of an ounce entering the tank can cause problems. To help avoid the possibility of freeze-up, always keep tank control valve closed when not in use, even when tank is empty, to prevent moisture from collecting on the inside.

If regulator freeze-up should occur, you may attempt to thaw the regulator using a light bulb. **DO NOT USE AN OPEN FLAME OR HEAT LAMP.**

If moisture begins to cause problems, have your propane gas dealer inject a small amount of dry methyl alcohol in your tank (approximately one ounce to 20 pounds or one pint to 100 gallons) to help guard against regulator freeze-ups.

PROPANE VAPORIZATION IN COLD WEATHER

Propane gas vaporization increases and decreases in direct relation to ambient temperature. In other words, the lower the temperature, the slower the liquid propane will vaporize into a usable gas for appliances.

This means that in extremely cold weather when a large volume of gas is being used by the furnace for heating, it is possible to experience a loss of gas pressure.

At first, this problem may appear to be caused by an empty tank or a regulator freeze-up, but is actually caused by failure of the liquid gas to vaporize as fast as it is needed by the furnace.

The demand for propane to produce heat increases to the point where the gas cannot vaporize fast enough to keep the furnace going. The only solution to this problem is to reduce gas usage where possible.

Adjusting the temperature on the gas/electric refrigerator may be a first step. Using less hot water will also help, as well as refraining from using the gas cooktop. A final step is to lower the thermostat setting to reduce gas usage by the furnace.

Chalet

SECTION 6 - ELECTRICAL

Your coach is equipped with an electrical system consisting of two separate voltages:

- 12-volt DC system (battery current); and
- 120-volt AC system (household current)

The 12-volt system consists of two internal power sources, while the 120-volt system is operated from an outside power source or the optional 120-volt generator.

ELECTRICAL CAUTIONS

- Careless handling of electrical components can be fatal. Never touch or use electrical components or appliances while feet are bare, while hands are wet, or while standing in water or on wet ground.
- Improper grounding of the vehicle can cause personal injury. Do not plug the utility power cord into an outlet which is not grounded and do not adapt the plug to connect to a receptacle for which it is not designed.
- Do not attach an extension cord to the utility power cord.
- Be sure that all electrical appliances to be used contain 3-prong plugs for proper grounding.
- Avoid overloading electrical circuits. Replace fuses or circuit breakers with those of the same size and amperage rating only. Never use a higher rated fuse or breaker.
- Use caution when handling or working near electrical storage batteries. Always remove jewelry and wear protective clothing and eye covering. Avoid creating sparks.

ELECTRICAL SYSTEM – HOUSE 120-VOLT AC

The 120-volt system operates from the shoreline cord connected to an outside 120-volt utility service, such as those at campgrounds or from the 120-volt generator. When the shoreline cord is connected to an outside power source, or when the auxiliary electric generator is running,

the power converter automatically changes a portion of the 120-volt current to 12-volt DC current. All equipment in the motorhome that is normally powered by the house batteries is then powered through the converter.

In addition, the following equipment is entirely dependent on 120-volt current: air conditioner, refrigerator (when placed in AC mode), microwave oven, and any 120-volt electrical equipment used at convenience outlets.

EXTERNAL POWER CORD

(Shoreline)

The external power cord (commonly referred to as a “shoreline”) is stored in the utility compartment on the left (driver’s) side of the coach.



WARNING

Do not use an extension cord. Improper sized cords, damaged cords, and poor connections can lead to fire, which can result in death or serious injury.



WARNING

Do not connect the external power cord to any receptacle until you have verified proper polarity and grounding. Be sure all prongs of the supply cord are properly plugged into the receptacle. Failure to observe can result in death or serious injury.

The power cord is designed to ground the electrical system through the receptacle. It is also designed to carry the amperage output of most campground outlets. If the electrical receptacle to

be used is designed to mate with the prongs of the power cord plug, the electrical connection can be expected to carry rated load.

Connecting the Power Cord

To connect to an external source, remove the cord from the utility compartment and plug it into a suitable power outlet to provide external power to the coach and converter/charger system.

Your coach may be equipped with either a standard 30-amp system or an optional 50-amp system.

NOTE: Some parks do not have 50-amp service available, so you will need to connect to a standard 30-amp service pole using an adapter.

If your coach is equipped with standard 30-amp system, you cannot connect to a 50-amp service. Do not use adapters to connect 30-amp systems to a 50-amp service or you may cause an overload on electrical system components.

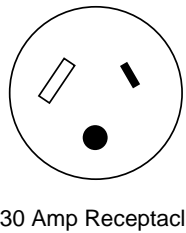
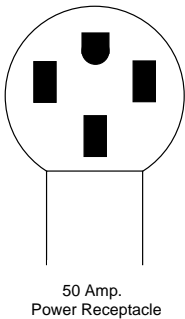

A rotating hatch in the compartment floor lets you route the shoreline cord through a passage in the bottom of the compartment so you can shut the compartment door while the shoreline is connected.

- 7. Flip the retainer in the center of the cover straight up.



- 8. Rotate the cover to the largest hole to pass the cord end through.

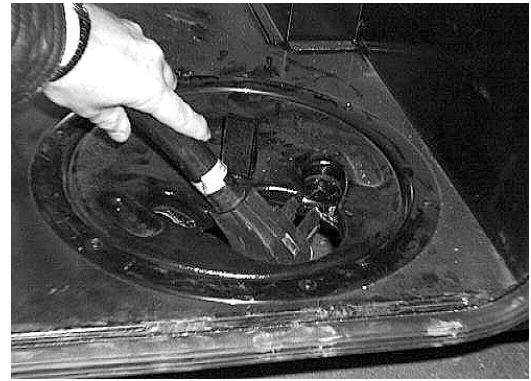

- 9. Then rotate to the smaller opening to enclose the cord.

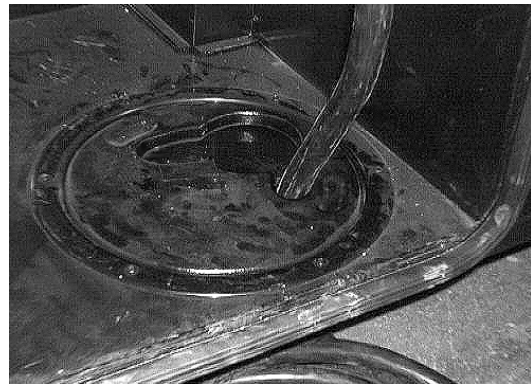

NOTE: Always keep service access passage closed while utility connection is not in use.

The power cord is designed to ground the electrical system through the receptacle. It is also designed to carry the amperage output of most campground outlets. If the electrical receptacle to

be used is designed to mate with the three prongs on the power cord plug, the electrical connection can be expected to carry rated load.

NOTE: Always keep service access passage closed while utility connection is not in use.

Park Fuses or Breakers

Most campgrounds are equipped with a fuse or circuit breaker at the receptacle (which we recommend shutting off before engaging or disengaging the power cord.) This protects the park's wiring, as well as the power cord on your vehicle from electrical damage. If electrical power fails, contact the park attendants and have them check the fuse or breaker for your supply receptacle.

INVERTER UNIT – 1000W –If Equipped

The inverter unit is located on the wall of the utility compartment.

NOTE: The inverter is not intended for steady use while “dry camping”. Batteries will deplete quickly with use of the inverter. The inverter is intended for limited, short term power usage when not connected to shoreline or generator power. The inverter can also be used while driving the motorhome because the engine alternator will charge the batteries while driving.



Inverter Charger Unit
(Located inside utility compartment)
-Typical View

NOTICE

Do not store items too closely around the inverter unit in the storage compartment. The inverter generates heat while operating and needs unrestricted airflow for proper cooling. Damage to the inverter can result.

The inverter changes 12-volt DC battery power into 120-volt AC power for use by 120-volt AC equipment inside the coach.

NOTE: Do not leave the shoreline plugged in during storage. Follow regular battery inspection and maintenance.

Inverter Control Panel –If Equipped

The inverter has a wall-mounted monitor/control panel. It will also display warnings for overload conditions or other operating failure conditions.



Inverter Control Panel
(Located near monitor panel)
-Typical View

When the inverter is not being used, it should be shut off at the control panel. The inverter could drain the house batteries if the shoreline is not connected to external power and the House/Coach Battery Disconnect switch is on.

Further Information

See the inverter control panel instructions in your InfoCase for complete instructions and charging setup directions.

**POWER CENTER
(Converter)**

The Power Converter is generally located in a lower cabinet face in the galley or living area of your coach, depending on model. It contains the house electrical system 120-volt circuit breakers and 12-volt circuit breakers or fuses.

The Power Converter changes 120-volt AC current from the auxiliary generator or the shoreline into 12-volt DC current for use by 12-volt equipment in the motorhome.

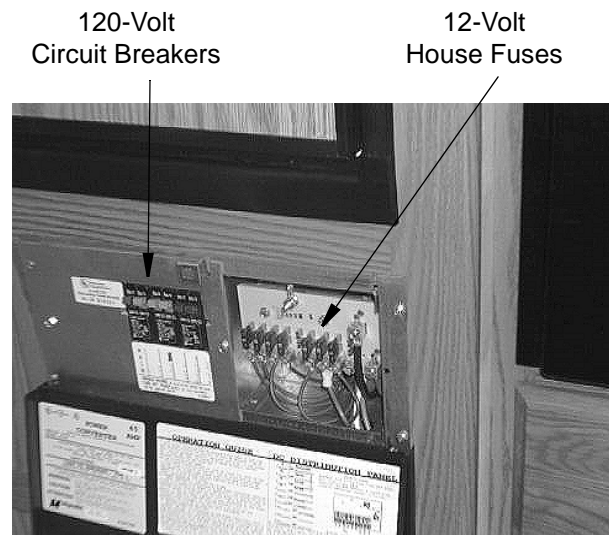

**Power Center
(Models 27N and 30T)
-Typical View**



**120-Volt House
Circuit Breakers** **12-Volt House
Circuit Breakers**

**Power Center
(Models 35B and 35F)
-Typical View**

Certain circuits, however, remain unchanged for use by items which require 120-volt current, such as the air conditioner(s), the refrigerator in AC mode, the microwave oven, etc.

NOTE: The converter will not change 12-volt DC current to 120-volt AC.

Current drawn from the house batteries passes through the Power Converter unchanged, although it is routed through a series of protective fuses located on the power panel.

NOTICE

Do not block the converter cover vents in any way. The converter generates heat while operating and needs unrestricted airflow for proper cooling. Damage to the converter can result.

Further Information

See the manufacturer's operation, care, and maintenance information provided in your InfoCase.

Charging Section

The converter charges house batteries while 120-volt external power is connected. The converter will automatically “sense” the condition of the battery. If it is below “full charge”, the Charging Section will start charging the batteries.

If the house batteries have been extremely discharged, they will accept charge at a relatively high amperage rate. If they are only slightly discharged, they will charge at a lower amperage rate. The rate of charge will decrease as the batteries reach “full charge”, then will continue “trickle” charging at a very low amperage rate. If your battery does not charge as described above, it is possible the battery is defective.

Thermal Overload

A thermal overload will “break” the 120-volt AC power to the converter section of the Power Center if the Power Converter becomes overheated. This can result from operating above its maximum limit for an extended period of time or by obstruction of ventilation to unit.

NOTE: The Power Converter section will automatically route 12-volt lights and motors to house battery power in this event.

The thermal overload will reset itself after a period of time, and the lights and motors will again resume operation from the Power Converter section. If the breaker trips again shortly after reset, take immediate steps to correct the cause of overheating. A portion of the house 12-volt load (lights or motors or both) should be turned off to reduce total load. Also, inspect the Power Converter to ensure ventilation is not obstructed.

CIRCUIT BREAKERS – HOUSE 120-VOLT AC

The breaker panel protects all 120-volt components in the motorhome from either an overload on the circuit or a short in the wiring or

component itself. When an overload or short develops, the breaker will open preventing damage to the system.

Shut off the equipment (example: roof air conditioner) and allow a brief cooling period. Then reset the breaker by moving the switch to “Off” and back to “On”. If the breaker is continually tripped and no overload is evident, have the system checked for a short in the wiring or the appliances.

The breaker panels are located behind a door or pull-off panel on a lower cabinet face in either the galley or lounge area or beneath the rear bed, depending on model.

NOTE: Breakers are labeled on panel. Arrangement may vary according to appliance and equipment options.



120-Volt House Circuit Breakers
-Typical View

ELECTRICAL OUTLETS – HOUSE 120-VOLT AC

A number of standard household electrical outlets are provided throughout the coach for connecting small appliances such as televisions, radios, toasters, etc.

An exterior outlet is also located on the outside of the coach near the entrance door or in a storage compartment on the passenger side of the coach.

**GROUND FAULT CIRCUIT
INTERRUPTER**

Bath, galley, and exterior outlets are connected to a GFCI (Ground Fault Circuit Interrupter), which is an extremely sensitive circuit breaker that will help to protect against severe electrical shock if a ground fault develops. If such a condition occurs, the GFCI will break the circuit by turning off the power to the protected outlets. Should this occur, unplug all the appliances on that circuit and press the reset button on the GFCI equipped outlet.

If the GFCI keeps tripping, have the electrical system checked and repaired, if necessary, before using again.

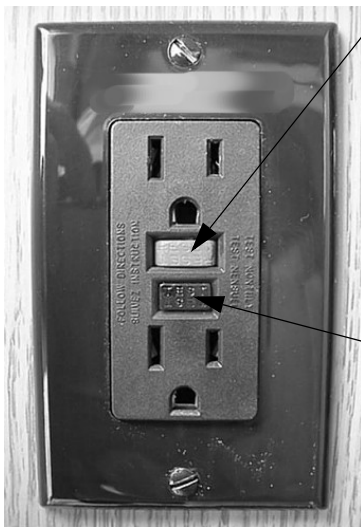

- Push to Reset circuit after monthly testing or ground fault tripping.

- Push to Test at least monthly. Should break circuit. Press Reset button to reconnect.

**GFCI Outlet
(Ground Fault Protector)**

! WARNING

The GFCI will not completely eliminate the risk of electrical shock. Infants and small children may still be affected.

**ELECTRICAL GENERATOR -
120-VOLT**

-If Equipped

! WARNING

Careless handling of the generator and electrical components can be fatal. Never touch electrical leads or appliances when your hands are wet, or when standing in water or on wet ground. Do not attempt to repair the generator yourself. Service should be performed by a qualified service center.

To use the 120-volt generator, plug the power cord into the generator receptacle within the utility compartment before starting the generator.

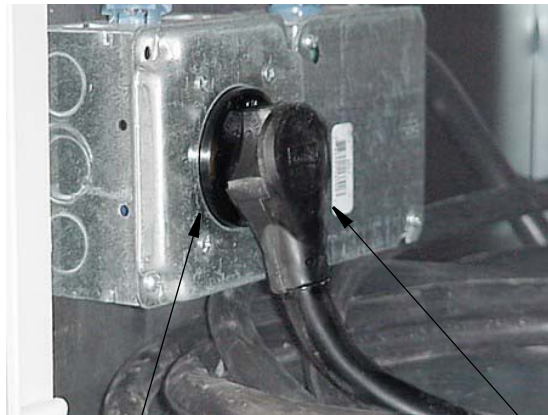

**Generator
Receptacle**

Power Cord

! WARNING

Do not plug the power cord into the generator receptacle while the generator is running. Electrical shock can cause personal injury.

Automatic Power Transfer Switch (available with 50-amp service only) -If Equipped

Whenever the generator is needed, an automatic power transfer system automatically switches the household electrical system to the generator 30 seconds after the generator is started. The 30 second delay allows the generator to start easily without the burden of electrical loads.



Automatic Power Transfer Box
(Located inside or behind
utility compartment)
-Typical installation shown

Generator Operation

See the manufacturer's operation, care and maintenance in your InfoCase.

Generator Hourmeter

This meter is located on the monitor panel. It registers the total number of hours that the generator has been operated.

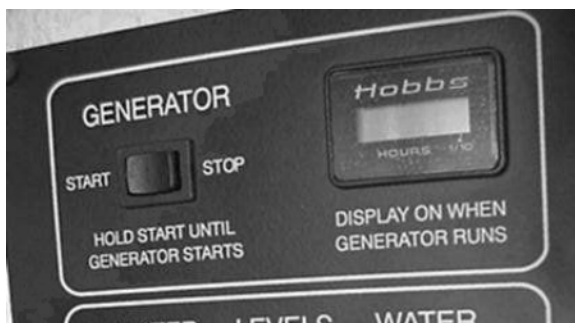

Refer to the hourmeter to determine when periodic maintenance is due and to record services which have been performed.

Operation Warnings and Cautions

WARNING

The exhaust of all internal combustion engines contains carbon monoxide (CO). This poisonous gas is colorless, odorless, tasteless, and lighter than air. The exhaust systems of both your motorhome engine and your generator engine have been installed with your safety in mind. However, certain precautions must be taken when using them to protect yourself from conditions beyond the control of the manufacturer.

1. Do not simultaneously operate the generator and a power vent, which could draw exhaust gases into the vehicle.
2. Do not open windows or vents on the end or side of the vehicle where exhaust pipe of the generator is located.
3. Park the vehicle so that the wind will carry the exhaust away from the vehicle. Also, note the position of other vehicles to be sure their exhaust will not enter your vehicle.
4. Do not operate the generator engine while parked if vegetation, snow, buildings, vehicles, or any other object can deflect the exhaust under or into the vehicle.

NOTE: Check auxiliary generator oil level frequently during periods of use.

Refer to the generator manufacturer's maintenance information in your InfoCase for specific recommendations.

ELECTRICAL SYSTEM - HOUSE 12-VOLT DC

The DC voltage system consists of the chassis battery, the 12-volt house batteries, and the 12-volt power converter.

Converter

See “Power Center.”

Chassis Battery

The chassis battery is used to operate the engine starter and automotive accessories and controls found on the instrument panel. The slideout room systems and the electric step are also connected to the chassis battery.

See your chassis manual for further information on chassis batteries and chassis electrical system.

House Batteries

House batteries are “deep-cycle” type batteries specially designed for recreational vehicle use. They will provide longer lasting power than standard automotive starting batteries and will withstand the frequent drain-and-recharge cycles that occur under the demanding conditions of a camping outing.

The house batteries supply power to 12-volt equipment located in the living area of the motorhome. This includes the following 12-volt powered components (if equipped): interior 12-volt lighting, range exhaust fan, propane furnace fan, fresh water pump, systems monitor panel, refrigerator, roof vent fans, and 120-volt electrical generator starter.

The house batteries can also provide emergency power to start the engine if the chassis battery is discharged. (See “Battery Boost Switch” in *Section 3 - Driving Your Motorhome*).

House batteries are automatically charged by the chassis alternator while the engine is running.

**HOUSE/COACH BATTERY
DISCONNECT SWITCH
(COACH BATT)**

The House/Coach Battery Disconnect switch lets you disconnect the house batteries from the 12-volt system of your coach during storage periods to avoid battery drain by electrical items that are hooked directly to the house batteries, such as clock displays and radio memories, etc.

Always leave this switch connected while using the coach.

NOTE: Some electronic displays and memory functions may need to be reset after power has been reconnected.

See also “Battery Care” elsewhere in this section.



House/Coach Battery Disconnect Switch
(Located near entrance door)
-Typical View

BATTERY ACCESS

The house/coach batteries (and chassis batteries in certain models) are located in a compartment beneath the interior entrance steps.

- Unfasten the step retainer, then lift the step upward and remove to service batteries.



-Typical View

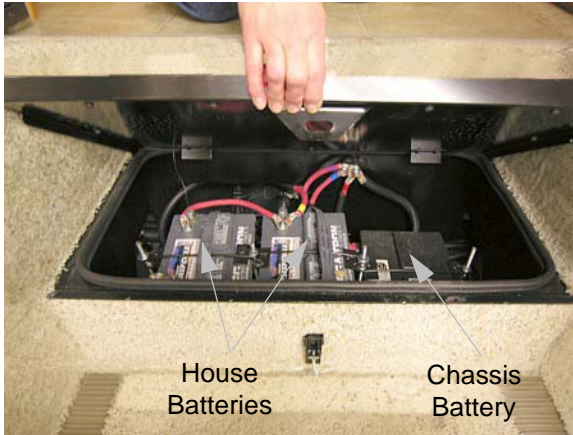

-Typical View

NOTICE

Always refasten battery retainers when returning a battery to the compartment.

BATTERY CARE

Lead-acid type batteries are electro-chemical devices for storing and releasing electrical charge. As such, they are simply an electrical reservoir, not an electrical source. As soon as energy is removed from the battery, it should be replaced by the engine alternator or the coach converter system.

If a battery sits unused for 30 days or more, especially during warm weather, it can develop a deposit of sulfate crystals on the metal plates inside the battery. This condition is called “sulfating” and prevents the battery from either releasing or accepting a charge. If this condition occurs, the battery must be replaced.

If a battery does not contain at least 80% charge during freezing temperatures, the electrolyte can freeze and crack the battery case.

The two best defenses against sulfating and insufficient charge are to:

1. Turn off the House/Coach Battery Disconnect switch to avoid parasitic discharge (the trickle discharge caused by directly connected components like propane gas detectors or digital clock displays, etc.)
2. Check the battery and recharge as necessary at least once a month during long storage periods. Turn the House/Coach Battery Disconnect switch off to avoid electrical arcing when attaching or detaching charger clamps.



WARNING

California Proposition 65 Warning:

Battery posts, terminals, and related accessories contain lead and lead compounds, chemicals known to the state of California to cause cancer and reproductive harm. Wash hands after handling.

NOTE: Do not leave the shoreline plugged in during storage. Follow regular battery inspection and maintenance.

Further precautions are:

- Check the state of charge periodically to avoid discharge or sulfating.
- To ensure that the battery will always accept and hold a charge, follow these simple maintenance practices:
- Make sure the batteries always remain securely clamped in the battery tray.
 - Make sure battery cable clamps are tight on the terminal posts and are free of corrosion.
 - Neutralize corrosion buildup or acid film on top of battery by washing with a baking soda/water solution. Rinse with clear water.

NOTE: Make sure vent caps are on securely to prevent baking soda solution from entering the battery and contaminating the electrolyte fluid.

 **WARNING**

Before removing any battery cables or battery, make sure all 12-volt equipment in the motorhome is off and the power cord has been disconnected. Be sure to replace the battery terminal boot, if supplied, back onto the positive terminal after servicing. Care must be taken to avoid pinching the cable between any metal parts. Should the cable be damaged, a short circuit could result in personal injury or damage to equipment. Replace any damaged cables at once. Always remove jewelry and wear protective clothing and eye covering when checking or handling batteries.

 **WARNING**

To prevent wiring damage, it is essential when replacing the cables on the battery, or when using a “booster” battery, that the positive post and the positive cable be attached and the negative post and negative cable be attached. The posts are marked (+) plus and (-) minus. If a “boost charger” is used while battery is in the motorhome, disconnect both battery cables before connecting the charger to avoid damage to engine electronic components. Never attempt to charge or boost a frozen battery. An explosion can occur resulting in personal injury.

- Clean and tighten battery terminals and have the specific gravity checked at least once a year.
- Check the battery fluid level every month, or more often in hot weather. Fill to approximately 3/8 inch above the plates. **DO NOT OVERFILL.** If fluid is added during freezing weather, the motorhome should be driven several miles to mix water and electrolyte to prevent freezing.
- Fluid level check may be omitted if equipped with maintenance-free batteries.

Chassis Batteries

If your coach is going to be unoccupied for two weeks or more, Winnebago Industries® recommends disconnecting the chassis batteries in your coach to avoid battery discharge.

Turn the Chassis Battery Disconnect switch (located near the entrance door) to the OFF position to disconnect batteries.

CIRCUIT BREAKERS AND FUSES – HOUSE 12-VOLT DC

All 12-volt circuits and equipment in the coach area of the motorhome are protected by either a fuse panel or breaker panel. When a circuit is overloaded or a short develops in any part of the system, a fuse or breaker will shut down that circuit. If this happens, turn off all affected lights or appliances and reset the breaker or replace the fuse with a new one of equal amperage rating.

House 12-Volt Circuit Breakers (Models 35B and 35F)

A label on the panel states the amperage rating and circuit protected for each breaker.

The circuit breaker panel is located behind a door or pull-off panel on a lower cabinet face in either the galley/lounge area or beneath the rear bed, depending on model.



House 12-Volt Circuit Breakers
(Models 35B and 35F)
-Typical View

House 12-Volt Fuses (Models 27N and 30T)

A label on the panel states the amperage rating and circuit protected for each fuse.

The fuse panel is located on the right-hand side of the Power Converter.

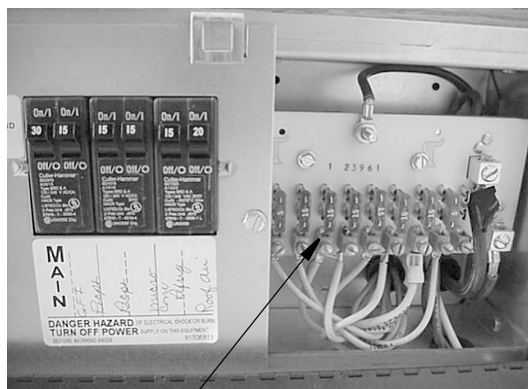

House 12-Volt Fuses
(Located on the right-hand side
of the Power Converter)
(Models 27N and 30T)
-Typical View

The fuse panel accepts only blade type plug-in fuses. Always replace fuses with those of the same amperage rating.

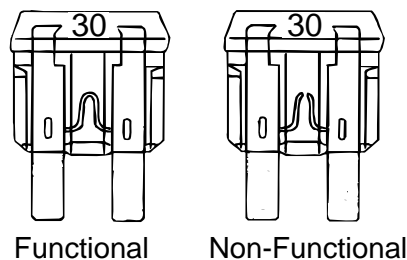

Battery Charge Meter

See related item under “Systems Monitor Panel” in *Section 4 - Appliances and Systems*.

Battery Boost Switch

See *Section 3 - Driving Your Motorhome* for information on the Battery Boost switch.

Automotive Chassis and House 12-Volt Circuit Breakers

A label on the Automotive Chassis and House 12-Volt Circuit Breaker panel states the amperage rating and circuit protected for each breaker.

NOTE: Breakers are labeled on panel.

Arrangement may vary according to appliance and equipment options.



Automotive Chassis and House
12-Volt Circuit Breakers
(Located inside passenger compartment)
-Typical View

Chalet

SECTION 7 - PLUMBING

FRESH WATER SYSTEM

The Fresh Water System provides water to the galley sink, shower, bathroom lavatory, toilet, and water heater. Water may be supplied by either of two sources:

- A fresh water tank and water pump located within the motorhome, or
- Any external fresh water source to which the motorhome may be connected, known as “city water”.

Water Pressure Regulators

Because city water pressure varies from location to location, we recommend obtaining an in-line water pressure regulator to prevent damage to any components, connections, and seals in your fresh water system.

These devices simply connect in-line between the supply hose and the city water input on the coach. We recommend regulators that control water pressure to **50 psi. max.**

Water pressure regulators are commonly available at most RV dealerships and many large retail discount or home supply centers.

Filling the Fresh Water Tank

Always fill the fresh water tank at an approved potable water filling facility or a known purified drinking water source.

The tank is filled through the City Water Connection (Fresh Water Inlet) located inside the water service center.

The Fresh Water valve routes the water from the city water hose to the fresh water tank for filling.

1. Attach hose to the Fresh Water Inlet.



Fresh (City) Water Connection
“Fresh Water Inlet”
(Located in the water service center)

2. Turn the Fresh Water valve to Tank Fill position.



Fresh Water Valve
(Located in water service center)

3. Turn city water supply ON.
4. Use the level display on the monitor panel to oversee filling of the tank, or when the tank is full, water will flow from tank vent tube beneath coach.

NOTICE

Do not leave fresh water connection unattended when filling tank. Failure to comply may result in tank expansion and property damage.

5. Turn OFF city water supply and disconnect from the Fresh Water Inlet.
6. Turn Fresh Water valve to Normal position to use the water pump. *The Tank Fill position is only for pressure filling the water tank from the city water hose connection.*



Fresh Water Valve
(Located in water service center)

Using City Water

When connected to an outside source of water, the water bypasses the water pump and storage tank and supplies pressure directly to individual faucets and toilet. A check valve built into the pump prevents water from entering the pump and filling the storage tank.

1. Connect hose to Fresh Water Inlet as described in previous steps.
2. With the Fresh Water valve in the Normal position, turn the Water Pump switch(es) OFF.

NOTE: Always keep the Fresh Water valve in Normal position unless you are filling the tank. If this valve is left in the Tank Fill position while using the city water, water will keep flowing into the tank and out

the tank vent tube onto the ground and the water pump will run without delivering water to faucets.

Disconnecting from City Water

1. Turn the city water supply OFF.
2. Open a faucet on the coach (such as the exterior wash station, if equipped) to relieve line pressure.
3. Disconnect hose from the coach and replace the cap on the Fresh Water Inlet.

NOTE: Ensure the Fresh Water valve is in NORMAL position to use the water pump. If the valve is in Tank Fill position, the pump will run continuously without delivering water.

WATER PUMP

When your coach is not connected to a city water supply, water is supplied from the fresh water tank by a water system demand pump. A demand pump is designed to run only when you are using water. When you open a faucet, the waterline pressure drops and the pump begins to run, and it will continue to run as long as the faucet is open. When you close the faucet, the line pressure backs up to the pump, and it shuts itself off.

The pump is self-priming and will run briefly to build up line pressure when the Water Pump switch is first turned on. See “Initial Waterline Priming” for instructions on using the water system for the first time.

Further Information

Refer to the Water Pump manufacturer’s operation, care, and maintenance information provided in your InfoCase.

Water Pump Strainer

The pump is equipped with a cleanable strainer to capture any possible tank-borne particles that could damage pump components.

NOTE: We recommend that you check and clean the strainer after each tankful of water during the first few uses of the Water

Pump system. Thereafter, remember to check it at least yearly, and be sure to empty water from it during winterization procedures.



Water Pump Strainer
-Typical View

To Clean Pump Strainer

- Ensure all Water Pump switches are OFF.
- Twist the inlet cap (bowl) “counter-clockwise” to unscrew from the strainer assembly.
- Remove the bowl and pull the strainer screen out of the bowl to tap out any particles and rinse clean.
- Insert the strainer screen back into the bowl, then screw the bowl back onto the strainer assembly.

NOTE: You must also empty the strainer when winterizing your coach to avoid water freezing and cracking the filter bowl.

Water Pump Switch

The Water Pump switch is located near the monitor panel (some models may have an additional switch in the water service center or within the bathroom area for your convenience).

While the switch is “ON”, the pump will automatically supply water as it is needed.

We recommend that you turn the Water Pump switch off whenever you will be away from the vehicle or not using the water system. In time, a

slow leak in a faucet could drain the water tank, fill the holding tank, and discharge the house batteries.

Initial Waterline Priming

1. Ensure that all water drain valves are closed, including water heater valve.
2. Turn Water Pump switch to “OFF” position.
3. Fill water tank.
4. Open all faucets, hot and cold.
5. Turn ON the Water Pump switch.
6. Close each faucet as it begins to deliver a steady stream of water (close cold water first.) Leave hot water faucets on until they also deliver a steady stream of water. This will ensure that the water heater is filled with water.
7. Check to ensure the Water Pump stops soon after all faucets have been closed.
8. The Water Pump is now ready for automatic operation. The pump will start when a faucet is opened and stop when the faucet is closed.

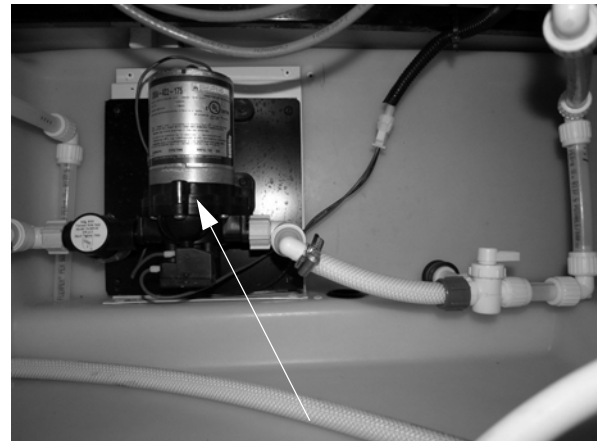

Water Pump
-Typical installation shown

- **Models 26PR and 30TR** - Located in passenger side compartment behind rear axle.
- **Model 32KR** - Located under bed. Remove panel beneath mattress to access.
- **Models 35FR and 36DR** - Located in utility compartment.

**DISINFECTING YOUR FRESH
WATER SYSTEM**

**(As required by NFPA®1192 Standard on
Recreational Vehicles)**

To ensure complete disinfection of the potable water system, it is recommended that the following procedure be followed on a new system, one that has not been used for a period of time, or one that could have become contaminated.

This procedure is also recommended before long periods of storage, such as over winter.

**Disinfecting with City Water Tank
Fill**

The fresh water tank must be filled through the City Water Connection (“Fresh Water Inlet”) located in the water service center.



Fresh (City) Water Connection
“Fresh Water Inlet”
(Located in the water service center)

This procedure requires temporarily connecting an external cartridge-type water filter assembly in-line between the city water hose and the city water fill to add disinfecting solution to the tank. These filters are commonly available at most RV supply stores.

NOTE: If you do not have an in-line cartridge filter, see City Water Hose Disinfection following this procedure for an alternate method of adding bleach solution to your tank.

1. Remove the filter cartridge and pour 1/2 cup of household chlorine bleach (sodium hypochlorite solution) for each 30 gallons of tank capacity into the empty filter canister, then screw the canister back onto the filter base.

 WARNING
Chlorine is poisonous. Do not misuse. Recap bottle and clean all utensils after use.

This solution will result in a residual chlorine concentration of approximately 50 ppm in the water system. *(If a 100 ppm concentration is desired as discussed in Step 3, use 1 cup of household bleach for each 30 gallons of tank capacity).*

The bleach will be drawn into the tank when the city water is turned on and the Fresh Water valve is turned to Tank Fill position.



Fresh Water Valve
(Located in water service center)

2. Fill the tank completely, then open each faucet in the coach and run the water until a distinct odor of chlorine can be detected in the water discharged. Do not forget the hot water faucets.
3. Let the system stand at least 4 hours when disinfecting with 50 ppm residual chlorine. *(If a shorter time period is desired, then a 100*

ppm chlorine concentration should be allowed to stand in the system for at least 1 hour).

4. Drain the fresh water tank.
5. Install the filter cartridge into the filter canister, then refill the tank with fresh water.
6. Open each faucet again and run fresh water to flush chlorinated water from the lines. Run the water until there is no odor of chlorine detected in the water discharged. Do not forget the hot water faucets.
(You may need to leave a hot water faucet open for some time to flush the water heater with clean water. You may also want to turn the water heater off until this is done to avoid wasting energy trying to heat “unused” water).
7. Water system is now disinfected.

NOTE: An alternate way is to connect a city water hose to your coach and pour the bleach into the other end of the hose using a funnel. Hold the hose upright to avoid draining the bleach. Connect the hose to a city water hydrant to force the bleach into the tank and fill the tank with water. This method has the additional benefit of disinfecting the city water hose at the same time.

Continuous Tank Disinfection (Superchlorination)

Some RVers like to ensure continuous sanitation of their fresh water tank by “superchlorination”– maintaining an effective low level of chlorine in the tank at all times.

- Add 1 teaspoon of chlorine bleach (sodium hypochlorite) to your tank for each 10 gallons of tank capacity. When you fill the tank, this will result in a 6.7 ppm level of chlorine, which should kill harmful bacteria and slime-forming organisms.
- Chlorine may be removed from drinking water by the cold water filter at the galley faucet (if equipped) or by installing an

activated carbon water purifier at the galley sink cold waterline or a separate drinking water faucet with filter (if equipped).

- Superchlorination does not affect city water usage, only the fresh water tank.

SHOWER HOSE VACUUM BREAKER

After using the shower, you may notice water dripping from the shower faucet assembly. The dripping results when vacuum in the shower hose (after closing the shower faucet) slowly releases and allows water remaining in the hose to drain down. This is a normal function of the shower valve assembly and is not a leak or defect.

If items are placed into the shower tub before shower valve vacuum release is complete, they may become wet.

EXTERIOR SHOWER/WASH STATION

–If Equipped

The Exterior Shower/Wash Station feature allows you to do things such as rinse off sand or salt after a swim, rinse off muddy boots, or bathe your pet outside the coach. Some models may have a Water Pump switch located near the shower faucet for convenience.



Exterior Shower/Wash Station
-Typical View

TOILET

The toilet in your motorhome is very similar to the household type, except that it is designed to use only a small amount of water per flush. It uses a high velocity jet of water, producing a swirl effect, to efficiently cleanse the bowl.

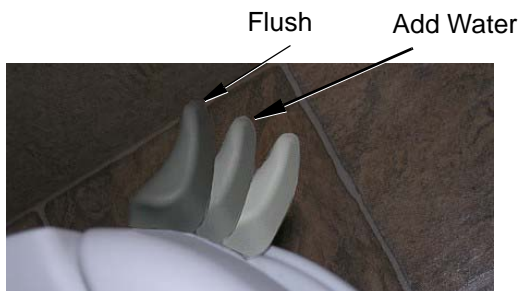

Important “Don’ts”

- Don't use facial tissue or regular toilet tissue in the RV toilet. These will not disintegrate sufficiently and will often cling to the sides of the holding tank. Toilet tissue made specifically for use in RV toilets and holding tanks is available at most RV supply centers.
- Don't dispose of sanitary napkins or other non-dissolving items in the toilet.
- Don't put automotive antifreeze or caustic chemicals, such as laundry bleach or heavy detergents into the toilet or holding tank. These products may damage plastic or rubber parts in the system.

Further Information

See the toilet manufacturer's operation information in your InfoCase for complete operating, care and maintenance information.

See winterizing instructions at the end of this section to prepare the toilet for storage in freezing conditions.

DRAINAGE SYSTEM (P-TRAPS)

Ensure there is an adequate amount of water in the drainage system p-traps to avoid sewer odor from entering your coach.

If you should experience a sewer odor, pour approximately 1 cup of water down each sink and shower drain in the coach.

**WASTE WATER SYSTEM
(Holding Tanks)**

The drainage system is self-contained and uses two separate holding tanks (Model 35B is equipped with four holding tanks - two black and two gray) to contain the waste water until it can be dumped at an appropriate waste water disposal site. This means you can use the toilet(s), sinks, and shower even in areas where utility hookups are not available.

The black water holding tank(s) contains the sewage from the toilet(s) and may include bathroom lavatory on some models. The gray water holding tank contains the waste water from the galley sink and shower, and may include bathroom lavatory.

See “Specifications” in *Section 1 - Introduction* for tank capacities for your model.

Dumping Holding Tanks

1. Remove sewage drain hose from water service center.
2. Remove dust cap from sewage drain outlet and connect sewage drain hose. Be sure it is firmly attached.



**Holding Tank Drain Valves
(Located in water service center)
-Typical View**

Black and Gray Waste Tank Drain Valve positions may be reversed, depending on floorplan and tank location

NOTE: The sewage drain outlet swivels downward (on certain models) when necessary to avoid bends in the sewage drain hose, which could trap solids while

dumping, or to provide more direct drainage while using on-site sewer hook-ups.

- Place the outlet end of sewage drain hose into disposal opening.

NOTE: Model 35B is equipped with two sets of Black and Gray Waste Tank Drain Valves - one set is in the driver side compartment ahead of rear axle, and the other set is in the driver side compartment behind the rear axle. Therefore, Steps 4 and 5 must be performed at each location.

- Open the Black Waste Tank Drain Valve with a quick pull and make sure there are no sags in the hose. Move the hose gently about to dislodge any waste and ensure complete drainage. Close Black Waste Tank Drain Valve as soon as tank is empty.



- 1st - Pull Black Waste Tank Drain Valve to drain Black Water (sewage) Tank, then close.

- 2nd - Pull Gray Waste Tank Drain Valve to drain Gray Water (sink/shower) Tank, then close.

-Typical View

NOTE: DO NOT OPEN BOTH VALVES AT ONCE. Do not open the Gray Waste Tank Drain Valve until the black tank is drained and Black Waste Tank Drain Valve closed to avoid sewage back-up into gray tank. Gray water also rinses any black water solids from the sewage drain hose.

- Open the Gray Waste Tank Drain Valve. Be sure there are no sags in the hose to ensure complete drainage. Close Gray Waste Tank Drain Valve as soon as tank is empty.
- Add an odor control chemical to the sewage holding tank through the toilet(s). These chemicals are available at most RV supply centers.
- Rinse sewage drain hose thoroughly with water before stowing.

NOTE: We recommend that you dump all holding tanks before traveling to avoid carrying unnecessary weight.

Using On-Site Sewer Hook-Ups

The sewage drain hose may remain attached to the sewage drain outlet and be routed out the bottom of the compartment while the motor home is parked and connected to an on-site sewage hook-up.

NOTE: Always keep service access passage closed while utility connection is not in use.

When using a sewer hook-up, keep the dump valves closed until a tank becomes full or when preparing to leave the site. This keeps the solids in suspension, allowing them to be carried out with the liquids when the dump valve is opened. If the valve is left open, the liquids will drain off, leaving solids in the tank. Should this accidentally happen, disconnect the hose, fill the tank about half full with water, and drive a few miles to dislodge the solids. A few starts and stops will aid in the process. Then reconnect the hose and drain in the normal manner.

Holding Tank Level Indicators

See “Systems Monitor Panel” in *Section 4 - Appliances* for further information on the monitor panel and checking tank levels.

See “Specifications” in *Section 1 - Introduction* for tank capacities for your model.

**WASTE WATER SYSTEM
(WASTE PUMP)**

(Holding Tanks)

-Model 35F only

The drainage system is self-contained and uses three separate holding tanks to contain the waste water until it can be dumped at an appropriate waste water disposal site. This means you can use the toilets, sinks, and shower even in areas where utility hookups are not available.

The two black water holding tanks contain the sewage from the toilets. The gray water holding tank typically contains the waste water from the galley sink, shower, and bathroom lavatories.

See “Specifications” in *Section 1-Introduction* for tank capacities for your model.

Waste Pump

The 12-volt Waste Pump disposes black holding tank waste (for the front toilet) through a small diameter sewer hose, which is then drained through the main sewage drain outlet.



Waste Pump
(Located in passenger side compartment ahead of rear axle)
-Typical installation shown

NOTE: If Waste Pump stalls, check breaker in the load center. If problem persists, remove end cap and manually turn pump shaft (located on the end of the waste pump) with a screwdriver.

Further Information

For complete operating instructions and troubleshooting tips, see the Waste Pump manufacturer’s user guide provided in your InfoCase.

Dumping Holding Tanks

1. Remove sewage drain hose from water service center.



Sewage Drain Hose
-Typical View

2. Remove dust cap from sewage drain outlet and connect sewage drain hose. Be sure it is firmly attached.



Sewage Drain Outlet
(Located in water service center)
-Typical View

3. Place the outlet end of sewage drain hose into disposal opening.
4. Open the Front Black Waste Tank Drain Valve #1 (located in passenger side compartment ahead of the rear axle).



Black Waste Tank Drain Valve #1 (Front)
(Located in passenger side
compartment ahead of rear axle)
-Typical View

- Open the Front Black Waste Tank Drain Valve #2 (located in water service center).



Black Waste Tank Drain Valve #2 (Front)
(Located in water service center)
-Typical View

- Press and Hold the Waste Pump switch (located in the water service center) and make sure there are no sags in the hose. Release the Waste Pump switch and close the Front Black Waste Tank Drain Valves #1 and #2 as soon as the tanks are empty.

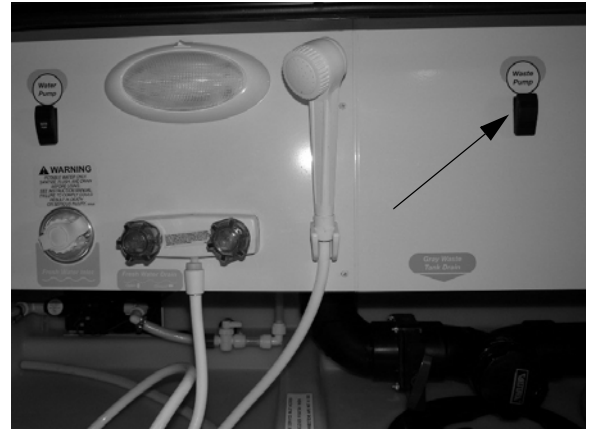

Waste Pump Switch
(Located in water service center)
-Typical View

NOTE: Sound of Waste Pump will change significantly when tank is empty.

- Open the Rear Black Waste Tank Drain Valve (located in the water service center). Move the hose gently about to dislodge any waste and ensure complete drainage. Close Rear Black Waste Tank Drain Valve as soon as tank is empty.



Black Waste Tank Drain Valve (Rear)
(Located in water service center)
-Typical View

NOTE: DO NOT OPEN BOTH VALVES AT ONCE. Do not open the Gray Waste Tank Drain Valve until the black tanks are drained and dump valves closed to avoid sewage back-up into gray tank. Gray water also rinses any black water solids from the sewage drain hose.

- Open the Gray Waste Tank Drain Valve (located in the water service center). Be sure there are no sags in the hose to ensure complete drainage. Close Gray Waste Tank Drain Valve as soon as tank is empty.



Gray Waste Tank Drain Valve
(Located in water service center)
-Typical View

- Add an odor control chemical to the sewage holding tanks through both toilets. These chemicals are available at most RV stores.
- Rinse sewage drain hose thoroughly with water and stow.

NOTE: We recommend that you dump all holding tanks before traveling to avoid carrying unnecessary weight.

Using On-Site Sewer Hook-Ups

The sewage drain hose may remain attached to the sewage drain outlet while the motorhome is parked and connected to an on-site sewage hook-up.

When using a sewer hook-up, keep the dump valves closed until a tank becomes full or when preparing to leave the site. This keeps the solids in suspension, allowing them to be carried out with the liquids when the dump valves are opened. If the valves are left open, the liquids will drain off, leaving solids in the tank. Should this accidentally happen, disconnect the sewage drain hose, fill the tank about half full with water, and drive a few miles to dislodge the solids. A

few starts and stops will aid in the process. Then reconnect the sewage drain hose and drain in the normal manner.

NOTE: Always keep sewage drain outlet capped while sewage connection is not in use.

Holding Tank Level Indicators

See “Systems Monitor Panel” in *Section 4–Appliances* for further information on the monitor panel and checking tank levels.

See “Specifications” in *Section 1–Introduction* for tank capacities for your model.

WATERLINE & TANK DRAIN VALVES

The water drain valves are used to drain water from the water tank and the water supply lines when preparing the motor home for storage or when sanitizing the water system.

To open or close the drain valves, turn the handles in the directions indicated by the following illustration.

See the Water System Drain Valve Locations chart at the end of this section for locations on your model.

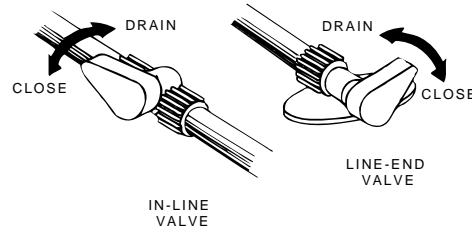

Waterline Drain Valves
(Typical)

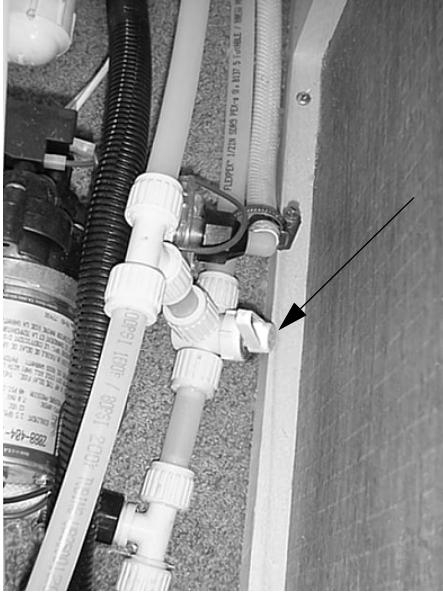

Waterline Drain Valve
-Typical installation shown



Water Tank Drain Valve
-Typical installation shown



WATER HEATER BYPASS VALVE

Your coach may be equipped with a Water Heater Bypass valve for easier winterization of waterlines using RV antifreeze. See “Water System Drain Valve Locations Chart” at the end of this section for location on your model.

Turn the handle as shown to either “Bypass” or “Flow” through the water heater.

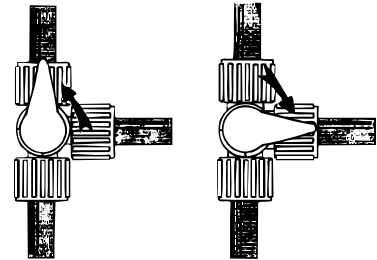

Normal
Flow

By-Pass
Mode

CAUTION

Leave bypass valve handle in NORMAL FLOW position if draining water and blowing out waterlines. Place in BYPASS position ONLY when using antifreeze solution in waterlines.

WINTERIZING PROCEDURE

You can winterize the water and plumbing system of your coach using one of the following two methods – 1) Blow out waterlines using compressed air or – 2) Fill waterlines with RV water system antifreeze.

**Method 1 – Blow Out Procedure
(Drain and purge waterlines using compressed air)**

1. **Level the Motorhome.** If the coach is not level, there may be “low points” in waterlines that can trap water in the lines and prevent it from draining properly.
2. **Drain Fresh Water Tank and Waterlines.** Open all waterline drain valves and drain fresh water tank. (See “Water System Drain Valve Locations” chart at end of this section for locations of drain valves on your model).
3. **Drain Exterior Shower/Wash Station.** Open exterior shower knobs and lay shower head on ground as shown to drain any water left in the shower line. Also place the tip of your finger into the city water inlet and gently press the backflow valve “button” in the center of the inlet to drain any water trapped in the inlet line.



Using exterior shower to drain waterline
-Typical View

4. **Remove the Ice Maker Water Filter Cartridge (if equipped).** Remove the ice maker filter cartridge from the filter assembly below the galley sink.
(If your coach is not equipped with an ice maker, proceed to the next numbered step).



Ice Maker Water Filter Assembly
(Located below galley sink)

- Twist the filter cartridge “counter-clockwise” about a quarter-turn and pull it down and out of the filter socket.

NOTE: The water filter head has a built-in bypass. No separate diverter plug is needed.

5. **Open Faucets.** Turn on the water pump and open all sink faucets and shower head knobs. Leave open after water stops flowing.
6. **Drain Toilet.** Press the toilet flush pedal and hold until water stops flowing in the toilet. Then turn Water Pump switch off.
7. **Drain Optional Appliances.** At this time, if your coach is equipped with an optional refrigerator ice maker, the waterlines for that must also be drained.
(See “Winterizing Optional Appliances” instructions at the end of this section.)
If not, proceed to the next numbered step.
8. **Drain Water Heater.** Turn off the Water Heater power switch before draining the water heater tank to avoid damage to the heating element. Drain the water heater by removing the plug from the base of the water heater tank, accessible from the outside of the coach.
(Requires socket and ratchet).



Water Heater Drain Plug
(Remove with socket)

- Also, open the Pressure-Temperature Relief valve at the top right portion of the tank to prevent air locking in the tank while draining.

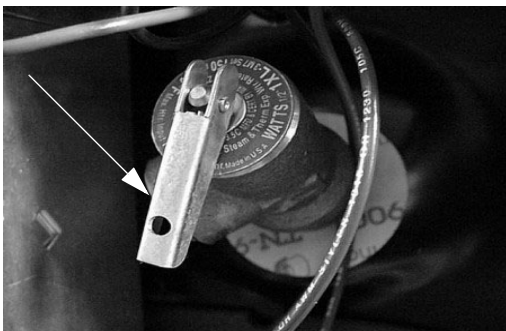

Pressure-Temperature Relief Valve
(Lift handle only when water heater is cold)

9. **Connect Air Pressure.** After water has stopped draining at all faucets and drain valves, leave faucets open and connect a “blow-out” plug to the city water connection on the coach. Then use a compressed air hose regulated to 30 psi or less to force air through the system. A blow-out plug can be purchased at any Winnebago® or Itasca® dealer.

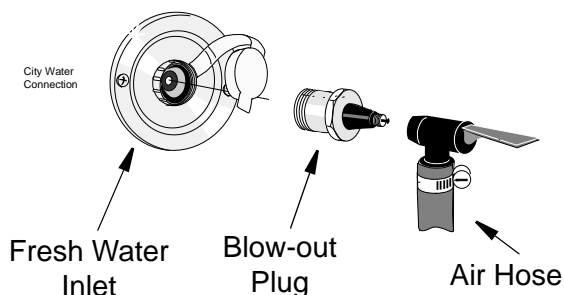

NOTICE

Limit air pressure to 30 psi to avoid damage to equipment.

NOTE: DO NOT burst air into the system. This can damage the water pump. It is better to let air in slowly.

10. **Let air flow for five minutes** until water is completely drained out of faucets and drain valves. Then close faucets one at a time.
11. **Drain Toilet.** Operate and hold toilet flush lever until water is completely drained from toilet.
12. **Turn air pressure off.** Disconnect water purge adapters. Recap the city water inlet to avoid contamination by dirt or insects.

After Disconnecting Air Pressure

13. Close all waterline and tank drain valves and all faucets to avoid contamination by dirt, insects, or rodents.
14. Reinstall the water heater drain plug and close the Pressure-Temperature Relief valve.
15. Pour about one cup of RV antifreeze down each drain for the galley sink, lavatory sink, and shower/tub. This fills the drain trap pipes to prevent holding tank odors from entering the coach during storage.

NOTE: It is not necessary to add antifreeze to the toilet since the flush valve will be closed.

Do not add automotive antifreeze or caustic chemicals such as bleach or laundry detergents into the toilet bowl or holding tanks. Although these products may have a deodorizing effect, they may damage plastic and rubber parts in the system.

16. Empty the water pump strainer filter bowl to avoid water freezing and cracking the filter bowl. See “Water Pump” previously in this section.

Dump and Clean Holding Tanks

17. Completely drain the sewage and waste water holding tanks at an approved waste disposal site. Drain the sewage tank first so the following waste water can rinse any waste solids from the dump outlet and sewer hose.
18. Close dump valves and refit the dust cap onto the drain outlet.
This will inhibit rust formation on valve shafts and prevent entry and contamination by airborne debris, insects, and rodents.

Your drainage and fresh water systems are now winterized.

See instructions for removal from storage in Section 11 - Maintenance and Storage.

**Method 2 – Antifreeze Fill
Procedure**

(Fill plumbing lines with RV water system antifreeze)

NOTE: As an alternative to totally draining the plumbing system, you may winterize tanks and lines by pumping non-toxic RV antifreeze through the system. This product is available from your dealer and from most RV supply stores. Follow directions on the container to determine the correct amount to use for your coach.

Your coach is equipped with a manually operated waterline winterization system for your convenience in winterizing fresh waterlines.

The system features a Winterization (diverter) valve with an antifreeze siphon tube to draw non-toxic RV water system antifreeze into the waterlines. There is also a Water Heater Bypass valve to avoid filling the water heater with antifreeze. See the “Water System Drain Valve Locations” chart at the end of this section for location on your model.

Leave the Water Heater Bypass valve handle in NORMAL FLOW position if draining water and blowing out waterlines. Place in BYPASS position ONLY when using antifreeze in waterlines.



WARNING

Never use automotive antifreeze/coolant in your RV water system. Auto antifreeze contains ethylene glycol which, if ingested, can cause blindness and can be fatal.

Remove Water Filters (if equipped)

1. **Remove the Ice Maker Water Filter Cartridge (if equipped).** Remove the ice maker filter cartridge from the filter assembly below the galley sink.
(If your coach is not equipped with an ice maker, proceed to the next numbered step).



**Ice Maker Water Filter Assembly
(Located below galley sink)**

- Twist the filter cartridge “counter-clockwise” about a quarter-turn and pull it down and out of the filter socket.

NOTE: The water filter head has a built-in bypass. No separate diverter plug is needed.

Set Up Winterization Valves

2. Turn Water Heater Bypass valve to BYPASS position. (See “Water System Drain Valve Locations” chart at the end of this section for location of bypass valve on your model).
3. Remove and save the protective cap from the end of the antifreeze siphon tube (save cap to cover tube after use).

4. Insert the end of the antifreeze siphon tube into a pail or other container with 2 to 3 gallons of non-toxic RV antifreeze solution.
5. Turn the Winterization valve handle so that it points toward the antifreeze siphon tube. (See “Water System Drain Valve Locations” chart at the end of this section for location on your model).

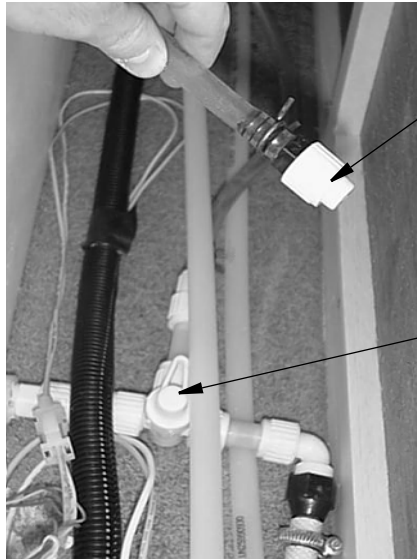

Antifreeze Siphon Tube

- Insert into container of RV water system antifreeze

Winterization Valve

- Point toward antifreeze siphon tube to winterize

RV Antifreeze Siphon Tube and Winterization Valve -Typical View

(See “Water System Drain Valve Locations” chart at the end of this section for location on your model)

NOTE: Ensure that all drain valves are *CLOSED* before pumping RV antifreeze into the water system. Refer to the “Water System Drain Valve Locations” chart at the end of this section for valve locations on your model.

Fill Lines

6. Turn the Water Pump switch on.
7. Open each hot and cold water faucet handle in the coach - one at a time, until antifreeze solution just begins to flow from the faucet, then close.
Do not forget the exterior shower/wash station knobs.

8. Press the toilet flush pedal and hold until antifreeze begins flowing into the toilet. Leave small amount of antifreeze that remains in the bowl.

When Done Adding RV Antifreeze

9. Turn the Water Pump switch off.
10. Turn the Winterization valve so it points toward the waterline to the water pump. This will stop the flow from the antifreeze siphon tube and revert the tank line flow to the water pump.
11. Replace the protective cap onto the end of the antifreeze siphon tube to keep out insects and debris when not in use.

Drain Water Heater

12. Turn off the Water Heater power switch before draining the water heater tank to avoid damage to the heating element.
13. Drain the water heater by removing the plug from the base of the water heater tank, accessible from the outside of the coach (requires socket and ratchet).



Water Heater Drain Plug (Remove with socket)

- Also, open the Pressure-Temperature Relief valve at the top right portion of the tank to prevent air locking in the tank while draining.

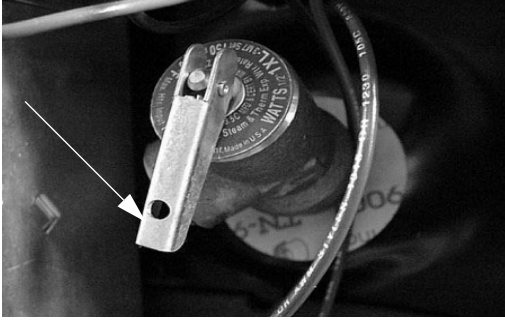

Pressure-Temperature Relief Valve
(Lift handle only when water heater is cold)

14. Reinstall the water heater drain plug and close the P-T Relief valve when drained.

Drain Optional Appliances

15. At this time, if your coach is equipped with an optional refrigerator ice maker, the waterlines for that must also be drained.
(See “Winterizing Optional Appliances” instructions at the end of this section.)
If not, proceed to the next numbered step.

Fill Drainage System P-Traps

16. Pour about one cup of RV antifreeze down each drain for the galley sink, lavatory sink, and shower/tub. This fills the drain trap pipes to prevent holding tank odors from entering the coach during storage.

Dump and Clean Holding Tanks

17. Completely drain the sewage and waste water holding tanks at an approved waste disposal site. Drain the sewage tank first so the following waste water can rinse any waste solids from the dump outlet and sewage drain hose.
18. Close dump valves and refit the dust cap onto the drain outlet. This will inhibit rust formation on valve shafts and prevent entry and contamination by airborne debris, insects, and rodents.

Your drainage and fresh water systems are now winterized.

See instructions for removal from storage in Section 11 - Maintenance and Storage.

To Winterize the Waste Pump (Model 35F with forward bathroom toilet)

- Ensure that black and gray holding tanks are completely empty.
- Pour 2 gallons of RV antifreeze down forward bathroom toilet.
- Press and Hold the Waste Pump switch for approximately 5-10 seconds to get antifreeze into the pump.

WATER SYSTEM DRAIN VALVE LOCATIONS		
Model	System	Drain Valve Locations
Model 30TR	Waterlines	<ul style="list-style-type: none"> Open exterior shower faucet and lay shower head on ground (if equipped). (If your coach is not equipped with an exterior shower, there will be in-line drain valves located behind the service panel in the water service center and one (1) valve located in passenger side compartment behind rear axle). <i>Also, place the tip of your finger inside the city water connection and gently press the backflow valve (small "button" in center of connector) to drain any water left in the city waterline.</i>
	Water Tank	<ul style="list-style-type: none"> Drain valve in driver side compartment behind rear axle.
	Water Heater	<ul style="list-style-type: none"> Drain plug on outside of coach behind service door. Use socket to remove drain plug.
	Water Heater Bypass Valve	<ul style="list-style-type: none"> Valve located in galley cabinet. Remove drawer on right-hand side to access.
	Winterization (Antifreeze) Valve	<ul style="list-style-type: none"> Valve and siphon tube located in passenger side compartment behind rear axle.

Model 26PR	Waterlines	<ul style="list-style-type: none"> Open exterior shower faucet and lay shower head on ground (if equipped). (If your coach is not equipped with an exterior shower, there will be in-line drain valves located behind the service panel in the water service center and one (1) valve located in passenger side compartment behind rear axle). <i>Also, place the tip of your finger inside the city water connection and gently press the backflow valve (small "button" in center of connector) to drain any water left in the city waterline.</i>
	Water Tank	<ul style="list-style-type: none"> Drain valve in passenger side compartment behind rear axle.
	Water Heater	<ul style="list-style-type: none"> Drain plug on outside of coach behind service door. Use socket to remove drain plug.
	Water Heater Bypass Valve	<ul style="list-style-type: none"> Valve in galley cabinet. Open door under galley sink to access.
	Winterization (Antifreeze) Valve	<ul style="list-style-type: none"> Valve and siphon tube located in passenger side compartment behind rear axle.
Model 32KR	Waterlines	<ul style="list-style-type: none"> Open exterior shower faucet and lay shower head on ground (if equipped). In-line drain valves located behind the service panel in the water service center. <i>Also, place the tip of your finger inside the city water connection and gently press the backflow valve (small "button" in center of connector) to drain any water left in the city waterline.</i>
	Water Tank	<ul style="list-style-type: none"> Under bed. Remove panel beneath mattress to access.
	Water Heater	<ul style="list-style-type: none"> Drain plug on outside of coach behind service door. Use socket to remove drain plug.
	Water Heater Bypass Valve	<ul style="list-style-type: none"> Valve behind water heater. Remove return air grill in refrigerator cabinet to access.
	Winterization (Antifreeze) Valve	<ul style="list-style-type: none"> Valve and siphon tube located under bed. Remove panel beneath mattress to access.

Model 35FR	Waterlines	<ul style="list-style-type: none"> Open exterior shower faucet and lay shower head on ground (if equipped). (If your coach is not equipped with an exterior shower, there will be in-line drain valves located behind the service panel in the water service center. <i>Also, place the tip of your finger inside the city water connection and gently press the backflow valve (small "button" in center of connector) to drain any water left in the city waterline.</i>
	Water Tank	<ul style="list-style-type: none"> Drain valve in driver side compartment behind rear axle.
	Water Heater	<ul style="list-style-type: none"> Drain plug on outside of coach behind service door. Use socket to remove drain plug.
	Water Heater Bypass Valve	<ul style="list-style-type: none"> Valve behind water heater. Remove drawer below oven to access.
	Winterization (Antifreeze) Valve	<ul style="list-style-type: none"> Valve and siphon tube are located in the utility compartment (driver side).
Model 36DR	Waterlines	<ul style="list-style-type: none"> Open exterior shower faucet and lay shower head on ground (if equipped). (If your coach is not equipped with an exterior shower, there will be in-line drain valves located behind the service panel in the water service center. <i>Also, place the tip of your finger inside the city water connection and gently press the backflow valve (small "button" in center of connector) to drain any water left in the city waterline.</i>
	Water Tank	<ul style="list-style-type: none"> Drain valve in utility compartment (second door behind driver side rear axle).
	Water Heater	<ul style="list-style-type: none"> Drain plug on outside of coach behind service door. Use socket to remove drain plug.
	Water Heater Bypass Valve	<ul style="list-style-type: none"> Valve behind water heater. Remove drawer in wardrobe to access.
	Winterization (Antifreeze) Valve	<ul style="list-style-type: none"> Valve and siphon tube are located in the utility compartment (driver side).

Chalet

SECTION 8 - ENTERTAINMENT

AUDIO/VIDEO SYSTEM CABLES

A set of standard, color-coded AV System Cables are provided in the front overhead entertainment center cabinet for connection of your choice of DVD player or home theater system.



Audio/Video System Cables
(Located in front overhead entertainment center cabinet)



Front TV Ignition Switch Interlock
-Typical View

AUDIO-VIDEO SYSTEM BASIC OPERATION

NOTE: For your convenience, we have also included a handy, tear-out version of this “AV System Basic Operation” guide in Section 8 of your Operator’s Manual Supplement. See your InfoCase for specific operating guides for audio and video components.

FRONT TV IGNITION SWITCH INTERLOCK

-If Equipped

If your coach is equipped with a front overhead TV, it is plugged into a special electrical outlet with a built-in ignition switch interlock. The device allows the front overhead TV to operate only when the ignition key is in the Off or Accessory positions.

DVD PLAYER

-If Equipped



The DVD player video output is connected to the lounge TV and plays through the TV stereo speakers or the deluxe sound rear radio speakers in the lounge area of the coach.

Set TV Sound Output

- Use the TV Menu button to set TV audio output to Variable Audio Output. (See TV owner’s manual for instructions.) This will connect TV stereo sound output to the deluxe speakers in the lounge area.
- Volume is adjusted with the TV remote or volume buttons.

Set TV Video Input

- Turn TV and DVD player On.
- Press the SOURCE button on the TV or TV remote to select “INPUT 1.”
- The TV screen will display the DVD player logo when the correct input is selected.

Play DVD

- Insert DVD into player. DVD will begin to load automatically. TV screen will typically show “READING” or “LOADING”.
- The DVD may load directly to the main title/menu screen or it may begin to play previews. You may be able to skip previews if desired by pressing the NEXT button until you see the main menu screen.

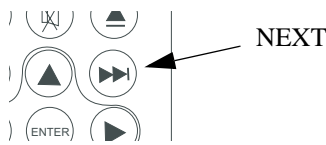

- When the main menu screen appears, use the arrow buttons on the DVD remote to select the desired entry or press the ENTER or PLAY buttons on the remote (or “Play” button on DVD player) to begin playing the feature.

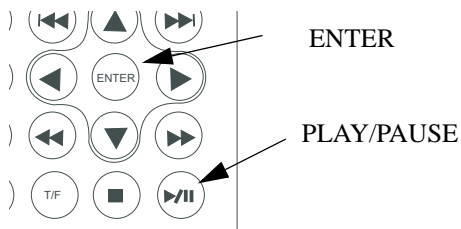

- Volume is adjusted with the DVD remote (or volume buttons on DVD player).

Further Information

For further information and operating instructions, see the manufacturer’s information included in your InfoCase.

CD/DVD PLAYER

(& Stereo Radio)

Exterior Entertainment Center

–If Equipped



The TV operates from 120-volt AC household current only, so you must have either the shoreline connected, the generator running, or the inverter turned on (if equipped).

The exterior entertainment center TV is connected to the exterior DVD player, the rooftop antenna, and the park cable input.

Play DVD

- Turn TV and DVD player On.
- Press the SOURCE or INPUT button on the TV or TV remote to select INPUT or AV.
- The TV screen will display the DVD player logo when the correct input is selected.
- Insert DVD into player. DVD will begin to load automatically. TV screen will typically show “READING” or “LOADING”.
- The DVD may load directly to the main title/menu screen or it may begin to play previews. You may be able to skip previews if desired by pressing the NEXT button until you see the main menu screen.

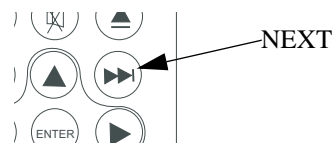

- When the main menu screen appears, use the arrow buttons on the DVD remote to select the desired entry or press the ENTER or PLAY buttons on the remote (or “Play” button on DVD player) to begin playing the feature.

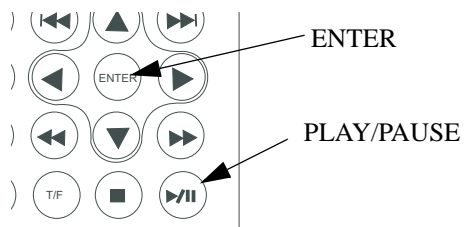

- Volume is adjusted with the DVD remote (or volume buttons on DVD player).

Antenna

- Turn On antenna booster inside coach.
- Turn On TV and tune to desired channel.



Cable

(Park cable input located in power cord compartment)

- Turn Off antenna booster inside coach. See above photo.
- Turn On TV and tune to desired channel.

Further Information

For further information and operating instructions, see the manufacturer’s information included in your InfoCase.

FLIP-DOWN SCREEN VIDEO PLAYERS

(Rear Bunk models only) -If Equipped

The flip-down LCD screen DVD Video Players are mounted overhead in each of the bunk beds.

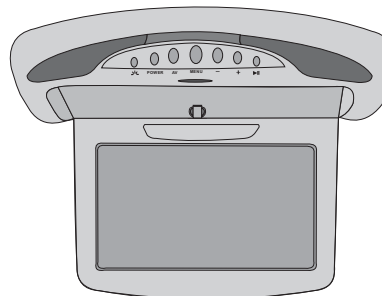

The Video Players operate independently so the occupant of one bunk may watch a DVD while the other watches a different DVD. The same DVD can be watched on both players at the same time as well. The top player is the master unit. Place the DVD in the top player and begin playing the DVD. Select AV1 input on the unit in the lower bunk to view the DVD playing in the upper bunk.

The players each contain auxiliary audio-video inputs for connection of a video game system or other audio-video equipment if desired.

Remote Control and Wireless Sound

- A sensor array above the screen of each Video Player receives command signals from the remote control.
- The sensor array also continuously transmits wireless sound signals for reception on IR wireless headphones.
- See Video Player instruction guide in your InfoCase for remote control instructions and additional information on wireless headphones.

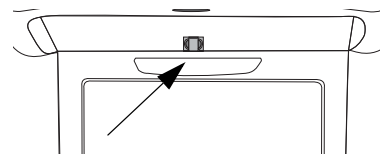

12-Volt Master Power

- The Video Players operate on 12-volt DC current. Turn on the 12-volt master power (TV) switch shown, located on the backwall of the top bunk.



NOTE: To avoid drain on the 12-volt house battery, we recommend turning the master power switch off when Video Players will not be in use.

Video Player Power ON/OFF

- Press the POWER button on either the remote control or the unit once to turn the power on. Press the same button to turn the player off.
- Push the open button (located on the front of your screen) and lower the monitor to the desired level. You may also adjust the swivel angle.

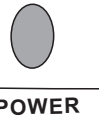

To Play DVD

- Insert the DVD label side down (facing you) into the slot on the side of the player. The player will automatically switch to DVD mode. The screen will display the DVD logo and begin to read the disc.
- The DVD may load directly to the main title/menu screen or it may begin to play previews. You may be able to skip previews if desired by pressing the NEXT button on the remote until you see the main menu screen.
- When the main menu screen appears, press the PLAY button on the player or ENTER button on the remote control to begin playing the feature, or use the arrow buttons to select the desired entry.
- Volume is adjusted with the +/- buttons on the player or the remote control.



- Insert the CD label side down (facing you) into the slot on the side of the player. The player will automatically switch to proper mode to play audio or video CD.

To Connect Game Systems or Other A/V Components

- Plug the audio and video cables of the game system or component into the audio-video input jacks at the rear underside of the Video Player.
- Switch the game system or component ON.
- Press AV button on Video Player to select. VIDEO 1 or VIDEO 2 input. (The component logo or other indication may appear on screen when proper input is selected).
- Operate game system or component using the component's controller(s).
- See Video Player instruction guide in your InfoCase for more information.

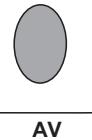

Reading Lights

- Push the light button to turn the reading lights on and off.

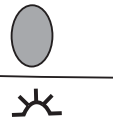

BEDROOM DVD/SATELLITE RECEIVER CONNECTION

If your coach is equipped with a bedroom TV, connections are provided for the TV to connect to a DVD player, satellite receiver, video game, or video camera.

To Play CD Audio (or CD Video)

- The Video Player is also capable of playing CD Audio music and CD Video discs.



Bedroom DVD/Satellite Receiver Connection
-Typical View

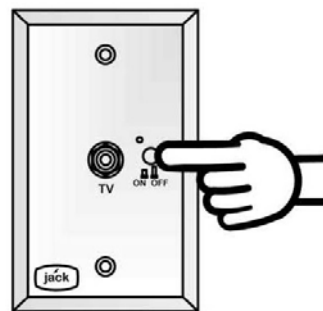

Digital Antenna Power Switch
(Located in an overhead cabinet or mounted on a wall near the TV)

2. Turn ON the Signal Meter Power switch (located on the side of the Signal Meter).

TV ANTENNA - DIGITAL (Jack® Digital HDTV Over-the-Air Antenna)

Your coach is featured with a digital antenna, which provides crystal clear digital HD reception of over-the-air channels in addition to superior broad reception range.

The digital antenna is equipped with a built-in amplifier for maximum VHF and UHF programming.

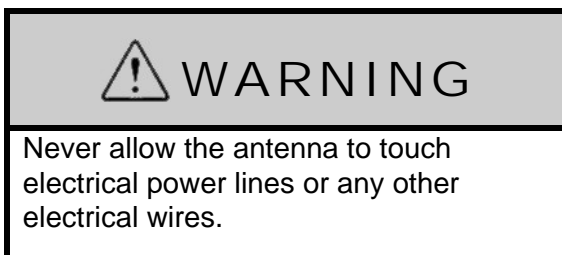

Operating the Digital Antenna

1. Turn the Digital Antenna Power Switch ON.

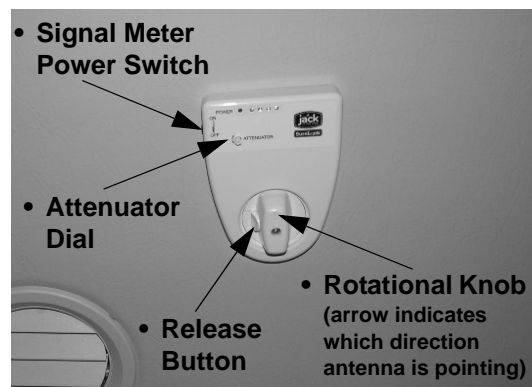

Digital Antenna Signal Meter
(Located on ceiling)

3. Rotate the Attenuator Dial fully **CLOCKWISE**.
4. Press Release Button on the Rotational Knob and rotate antenna (until maximum number of LED lights illuminate on the Signal Meter).

NOTE: LED lights will illuminate from left to right. All LED lights may not illuminate, depending on signal strength.

5. Rotate Attenuator Dial **COUNTER-CLOCKWISE** until the last illuminated LED light flickers.
6. Rotate antenna to illuminate the last flickering LED light.
7. Repeat Steps 5 and 6 to pinpoint signal reception.

SECTION 8 - ENTERTAINMENT

Chalet

NOTE: Refer to television manufacturer's instructions to scan for available channels.

Further Information

See the antenna manufacturer's user guide provided in your InfoCase for complete operating and maintenance information.

TV SIGNAL AMPLIFIER

The TV Signal Amplifier is built into the antenna and can be turned on or off with a power switch located on a switchplate inside the front overhead cabinet.

An indicator light will glow when the switch is on and the TV Signal Amplifier is active.



TV Signal Amplifier Power Switch
(Located in front overhead cabinet)
-Typical View

TV DIGITAL SATELLITE SYSTEM WIRING

This coach is pre-wired for installation of a digital satellite TV system. Coaxial cable connections to hook up your satellite receiver are located near the entertainment center cabinet.

A second connection may be included in an overhead cabinet in the bedroom for the rear TV (if equipped).

See your authorized Winnebago Industries® dealer for proper installation and sealing of roof mounted components.



Interior Connection for Satellite Dish
(Located in cabinet near TV)
-Typical View

SATELLITE DISH AND CABLE TV CONNECTIONS

The exterior satellite dish and cable television input connections are located in the utility compartment or water service center, depending on model.



Satellite Dish and Cable TV Connections
(Located in utility compartment
or water service center)
-Typical View

EXTERIOR ENTERTAINMENT CENTER

-If Equipped

The exterior entertainment center contains a stereo radio/CD player, electrical outlets and a convenient TV hook-up for your outdoor listening or viewing pleasure.

NOTE: These electronic devices and speakers are not designed to be waterproof. Please take measures to prevent rain or other precipitation from entering the entertainment center by closing the compartment door or ensuring that an awning will prevent entrance of precipitation.

Further Information

Please read the manufacturer's operating information in your InfoCase for operation of Radio/CD player.

Further Information

Please read the manufacturer's user guide in your InfoCase for complete operating instructions.

EXTERIOR ENTERTAINMENT CENTER

-If Equipped

The exterior entertainment center contains a TV, stereo radio/CD/DVD player, and audio/video hook-ups for your outdoor listening or viewing pleasure.

NOTE: These electronic devices and speakers are not designed to be waterproof. Please take measures to prevent rain or other precipitation from entering the entertainment center by closing the compartment door or ensuring that an awning will prevent entrance of precipitation.



Exterior Entertainment Center
-Typical View

Chalet

SECTION 9 - FURNITURE AND SOFTGOODS

LOUNGE CHAIR – SWIVEL GLIDER

-If Equipped

This chair is not equipped with a seat belt and is not intended for seating while the coach is in motion.

The hoop base of the lounge chair is mounted to the floor with a clamp as shown.



The clamp knob can be unscrewed to allow you to position the chair away from the wall.

WARNING

The chair must be clamped back into place and the glide mechanism locked before driving the coach.

The chair has a glide-lock mechanism to prevent chair movement while the coach is moving. The glide lock is located behind the seat skirt on the rear side of the seat base mechanism.

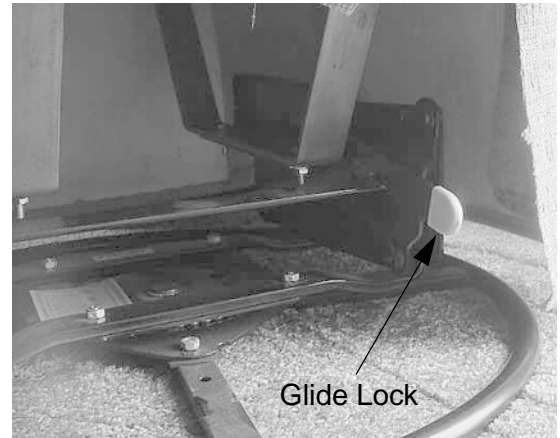

SLEEPING FACILITIES

WARNING

Sleeping facilities are not intended for use while vehicle is in motion. For safety, passengers must use safety belted seating positions while vehicle is in motion.

BUFFET TABLE AND CHAIRS

-If Equipped

(Typical view – your coach may differ according to floorplan)

Buffet Chairs

The buffet chairs are free-standing to allow greater freedom of movement. Folding chairs are also provided for additional seating when needed. The folding chairs are typically stored in the wardrobe.

Free-standing chairs are not intended for occupancy while the vehicle is in motion.

Before driving, always return buffet chairs to their storage location.

! WARNING

Properly secure all free-standing chairs, furniture, and loose items prior to driving. Moving items can cause driver distraction, possibly resulting in an accident that can result in death or serious injury.

Storing Buffet Chairs

1. Push chairs against opposite sides of the buffet table.



2. Bind chairs together with the provided strap, ensuring the strap goes through the ring located on the bottom side of the buffet table.



3. Latch strap and tighten as necessary for security.

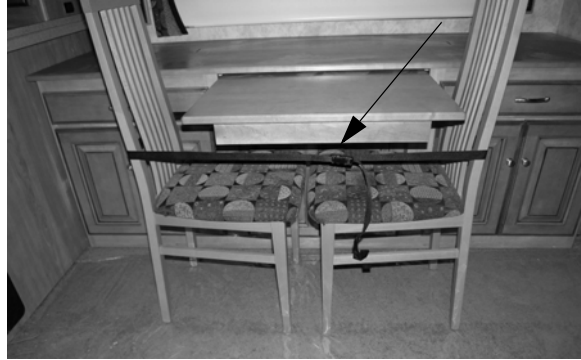

Buffet Table Extension

1. Grasp the edge of the buffet table and pull all the way out.



2. Insert buffet table extension.

NOTE: The buffet table extension is located inside the buffet cabinet.

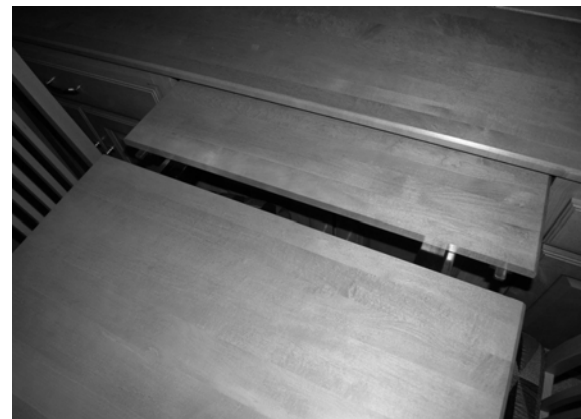

3. Push edge of buffet table in to adjoin with the table extension.



4. Reverse steps to store buffet table extension.

DINETTE/BED CONVERSION -If Equipped (Typical view – your coach may differ)



Dinette to Bed

1. Release the catch on the table leg brace and fold the leg up against the bottom of the table.



2. Remove the table from the wall support bracket by lifting the end of the table. Then lower the table to rest on the cleats attached to each dinette bench.



3. Arrange dinette cushions to cover bed area.



Bed to Dinette

1. Reattach the table onto the wall support and lower the table leg.

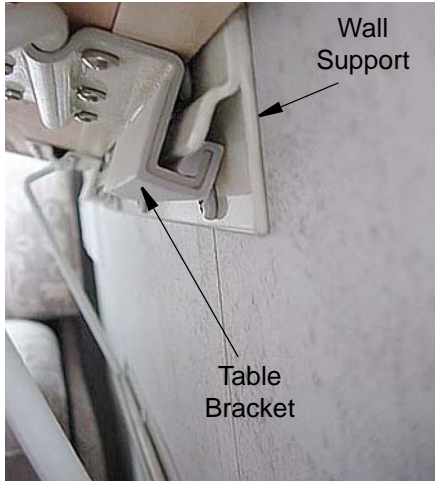

2. Make sure that the table leg is secured into the floor support bracket and the leg brace is locked.



2. Lift the dinette cushions upward and push table straight down.



3. Rotate lock rod counter-clockwise (right) to secure table in the lowered position.



4. Lower the dinette cushions.

DINETTE/BED CONVERSION - DREAM DINETTE™

**-If Equipped
(Typical view – your coach may differ)**

Dinette to Bed

1. Release the lock rod on the bottom of the dinette table by turning clockwise (left).



5. Arrange dinette cushions to cover bed area.



Reverse steps to convert back into dinette seating.

U-SHAPED DINETTE/BED CONVERSION

-If Equipped
(Typical view – your coach may differ)

The U-Shaped Dinette can be converted into additional sleeping space when needed by lowering the dinette table and arranging the dinette cushions.

1. Release both latches on the table leg to unlock.

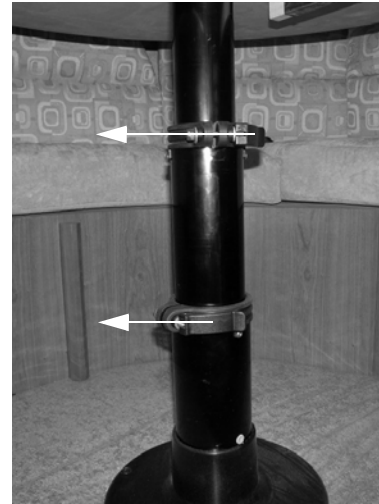

2. Lift edges of the dinette cushions up and push the dinette table straight down. Make sure the table is lowered as far as it will go so when arranging the cushions to cover the bed area, they are even with the other dinette cushions.

NOTE: You may find it easier to remove the dinette cushions completely before lowering the table, especially if just one person is converting the dinette into bed position.



3. Secure both latches on the table leg to lock in lowered position.



4. Arrange cushions to cover bed area.

NOTE: The cushions to cover the dining table section are located under the center dinette seat (lift removable panel below seat cushion to access) or you may use the back dinette seat cushion and two bolster cushions, depending on model.



Reverse steps to reassemble to dinette configuration.

Round Table Leaf Extension -If Equipped

Lift the leaf extension upward then reach beneath the tabletop and slide the support arms outward to hold the extension. Reverse steps to lower the extension.

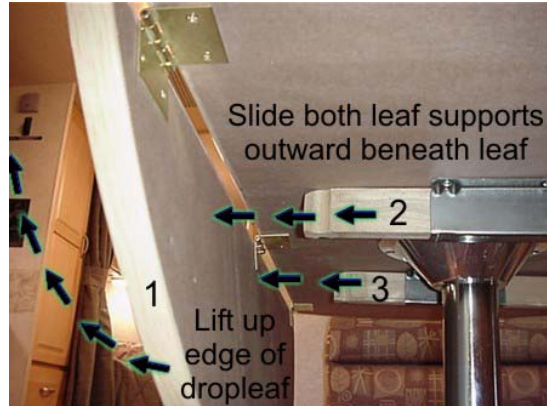

DINETTE CONVERSION

-If Equipped

(Typical view – your coach may be featured with two dinette tables and pedestal legs, depending on model)

Dinette Table Setup

1. Remove the dinette table(s) and pedestal leg(s) from rear wardrobe or galley cabinet, depending on model.
2. Insert dinette pedestal leg(s) into the metal receiver(s) on the floor in front of sofa.



3. Place dinette table(s) securely onto the dinette pedestal leg(s).



-Typical View

Reverse steps to store dinette table(s) and pedestal leg(s).

SOFA/BED CONVERSION

-If Equipped

Sofa to Bed

- Pull OUT on security latch (located on front of sofa) to release sofa seat.



Security Latch
(Located on front of sofa)
- Pull OUT to release

- Lift the front edge of the sofa seat upward and outward from the wall while gently pushing downward on the backrest until the cushions lie flat.
- The bed is now ready for use.

Bed to Sofa

- Push the front edge of the sofa seat toward the wall while lifting upward on the backrest until the sofa is fully seated against the wall and security latch “clicks” into locked position.

SOFA/BED CONVERSION

-If Equipped

Sofa to Bed

- Press DOWN on security latch handle (accessible through front sofa opening) to release sofa seat.

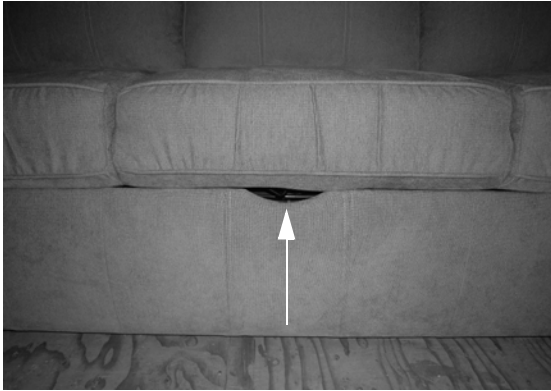

Security Latch Handle accessible through front sofa opening



Security Latch Handle
(Shown with sofa seat lifted)
- Press DOWN to release

- Lift the front edge of the sofa seat upward and pull outward from the wall while gently pushing downward on the backrest until the cushions lie flat.
- The bed is now ready for use.

Bed to Sofa

- Push the front edge of the sofa seat toward the wall while lifting upward on the backrest until the sofa is fully seated against the wall and security latch “clicks” into locked position.

SOFA/BED REMOVABLE ARMRESTS

-If Equipped

Some models may be equipped with removable sofa armrests that must be removed before converting the sofa into additional sleeping space.

Removing Armrests

- Remove the armrests from both ends of the sofa by lifting upward. A “fin” on the underside of the armrest holds it in place between the cushion and side of the sofa.



Remove armrest by lifting upward

Reinstalling Armrests

- Slide armrests into place at each end of the sofa.



Slide “fin” on bottom of armrest down between cushion and side of sofa

COMFORT SOFA SLEEPER -If Equipped (Typical View - your coach may vary according to floorplan)

Your coach may be equipped with a Comfort Sofa Sleeper, which is featured with an air bed that can be adjusted to the firmness of your choice by the touch of a button.

Sofa to Bed

1. Remove seat back cushions and set aside.

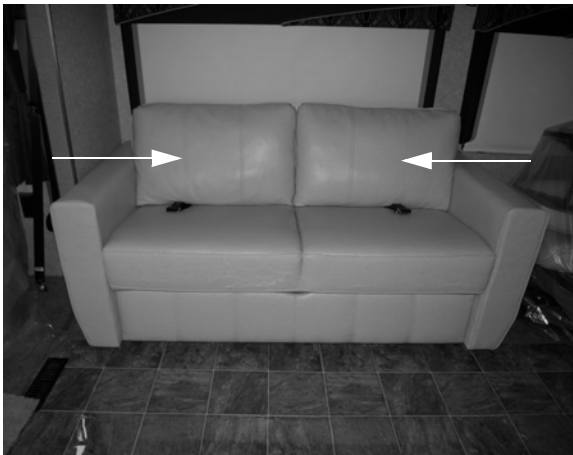

2. Using the pull strap (attached to the back side of the sofa), pull the sofa back out and extend all the way down to the floor.



3. Rotate the lever lock (located on the bottom right-hand side of the sofa air bed) "clockwise" to release the bottom section of the sofa air bed.



4. Unfold the bottom section of the sofa air bed and extend all the way down to the floor.



5. Unfold the air mattress so it is covering the sofa bed.



*NOTE: The air mattress is plugged into an AC power outlet behind the sofa.
It may be necessary to press the "Reset" button on the galley GFCI outlet before operating.*

6. Press and Hold the INFLATE button on the hand control to fill the air mattress.

NOTE: Ensure the Deflation Valve (located on the end of the air mattress) is closed before inflating.



Air Mattress Hand Control
(Located on the back side of the sofa)



7. Press and Hold the ADJUST button on the hand control to adjust the firmness of your air mattress to the setting that best suits your needs.



8. Insert index finger inside of Deflation Valve and press DOWN for a softer feel.

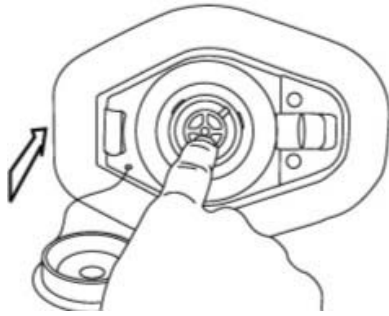

Bed to Sofa

1. Press and Hold the DEFLATE button on the hand control OR open the Deflation Valve (for quick deflation) until air mattress is completely deflated.

NOTE: If using Deflation Valve to deflate air mattress, pressing down on the mattress itself and forcing air out will speed up the deflation process.

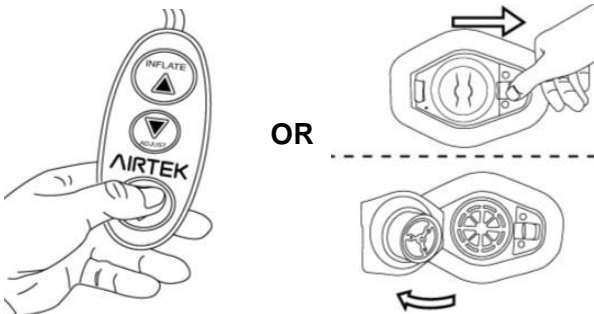

2. Fold bottom edges on each side of the mattress IN approximately 6 inches (to avoid pinching and obstruction of the mattress).

3. Fold in the bottom section of the air mattress.

NOTE: Leaving the Deflation Valve open while converting back into sofa position will help remove any remaining air for more compact storage.



4. Lift up the bottom section of the sofa bed and bring all the way up.



5. Rotate the lever lock “counter-clockwise”, securing the bottom section of the sofa bed back into locked position.



6. Grasp the pull strap and proceed to bring sofa all the way up. Once the sofa is back in original position, replace the sofa back cushions.



Further Information

See the air bed manufacturer's user guide provided in your InfoCase for complete air bed operating instructions, safety precautions, and repair information.

EXTENDABLE SECTIONAL SOFA

-If Equipped

Your coach may be equipped with an Extendable Sectional Sofa, which converts easily into additional seating space.

The sofa also converts into additional sleeping space. Refer to "Sofa/Bed Conversion" elsewhere in this section.

WARNING

Stow sectional sofa extension before retracting slide rooms. Failure to observe can cause injury and will cause equipment damage.

Extending Sectional Sofa

1. Lift and Hold the black lever (located on the arm of the sectional) to release the sectional extension.



2. Fully extend the sectional extension.



3. Grasp the pull strap (located on the front side of the sectional extension seat cushion) and pull UP and OUT.



4. Push front of seat cushion down, and then push rearward to secure the seat cushion into place.
5. Flip seat back support upright.



6. Install seat back cushion.



Reverse steps to store the sectional extension.

ROLLER SHADES (MANUAL) - SOLAR DAY/NIGHT

-If Equipped

Your coach may feature two-stage day/night roller shades that provide both solar heat protection and light-blocking capabilities.

The shade can easily be lowered by hand to any position, then retracted with a slight downward pull movement. When raising the shade, there is no need to hold onto the bottom of the shade - just simply let it go and it will rise at a slow, controlled rate.

You can pre-set the auto-stop positioning of your shade, which allows your shade to retract to a cushioned stop, at the positioning of your choice.



Further Information

For further operating information and care instructions, see the manufacturer's user guide provided in your InfoCase.

WOOD FURNITURE AND CABINETRY

-If Equipped

People are drawn to the natural beauty of wood. At Winnebago Industries®, our craftsmen work with the art found in each piece of wood to create cabinets of superior quality, backed by the Winnebago Industries warranty.

- Oak is a strong, open-grained hardwood that ranges in color from white to pink and reddish tones. Streaks of green, yellow, and even black may appear due to mineral deposits. Oak may also contain wormholes and wild, varying grain patterns. This distinct graining is considered a desirable quality and has made oak one of the most popular woods used for cabinetry.
- Maple is a close-grained hardwood that is predominately white to creamy-white in color, with occasional reddish-brown tones. While maple typically features uniform graining as compared to other wood species, characteristic markings may include fine brown lines, wavy or curly graining, bird's eye dots and mineral streaks. These traits are natural and serve to enhance maple's natural beauty.
- Cherry is characterized by its red undertones, but may vary in color from white to a deep, rich brown. Cherry is a close-grained wood with fairly uniform texture, revealing pin knots and curly graining. All wood will age with time and the finish will darken. This is especially true for cherry. This is a sought-after quality in cherry cabinetry, and those who select it expect this evolution.

No matter which species you choose for your new Winnebago Industries motorhome cabinetry, please keep in mind that no two pieces of wood are exactly the same.

Stains are likely to exaggerate the difference between open and closed grains and other markings in wood. Grain variation and color change should be expected. As hardwood ages, it will darken when exposed to different types of light. Color differences or changes in wood can also be caused by exposure to harsh chemicals, extreme heat, or other contributing external conditions.

Any color change that occurs in both the finish and the wood is considered part of the natural aging process and is not to be considered defect or damage.

Additionally, wood species exhibit other defining characteristics, such as mineral deposits/streaks, knots, sap runs, pin holes, and wormholes. These markings make the wood unique and contribute to its enduring beauty.

Therefore, since wood is a product of nature and will have certain natural characteristics and variances, they are not covered under the warranty.

SLIDEOUT ROOM TRAVEL LOCKS - ELECTRIC

-If Equipped

Some models are equipped with electric Slideout Room Travel Locks on slideout rooms to restrict movement of the slideout room while the vehicle is in motion. The slideout room will not extend until the lock is fully released.

Slideout Room Travel Lock switches are located on a wall in an area near the slideout room or incorporated into the monitor panel, depending on model.



Slideout Room Travel Lock
(Your coach may be equipped
with one or more types)
-Typical View

NOTICE

Release Slideout Lock before attempting to extend slideout room. The room will not extend until the lock is fully released. Fasten Slideout Lock before driving vehicle. See following instructions.

NOTE: *Be sure locks are fully released before attempting to extend or retract room. If the latch mechanisms are protruding more than 1/4", the room will not extend or retract and the slideout pump will run in idle/bypass mode.*

To Release

- Press and Hold the UNLOCK side of the Slideout Room Lock switch for about 7 seconds. (You may be able to hear the lock motor sound stop).

To Lock

- Press and Hold the LOCK side of the Slideout Room Lock switch for about 7 seconds. (You may be able to hear the lock motor sound stop).

Slideout Lock Drain Line

If your coach is equipped with electric Slideout Room Travel Locks, it is recommended to periodically inspect the slideout lock drain line (located near the top of the exterior slideout room).

NOTE: Depending on the length of your slideout room, there may be two Slideout Room Travel Locks. Therefore, two drain lines will need to be inspected (typically one located on each end of the slideout room).

It is possible for dirt and debris to collect inside the drain line and cause obstruction, not allowing water to drain properly. If the drain line is plugged, use a small tool (i.e. pipe cleaner) to dislodge any debris. Failure to comply may result in water backing up inside the drain line, resulting in water leaks and/or property damage.

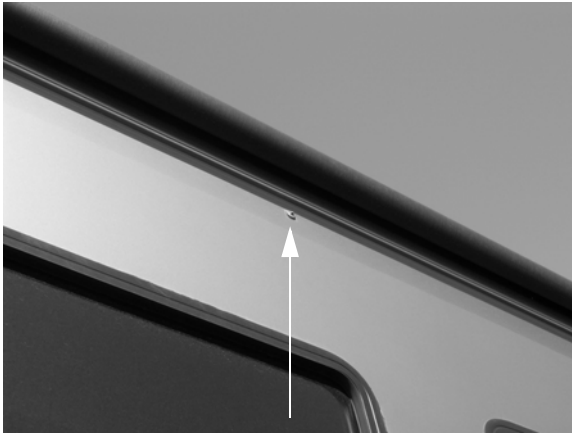

Slideout Lock Drain Line
(Located near the top of the
exterior slideout room)



SLIDEOUT ROOM TRAVEL LOCK

-If Equipped

Some models are equipped with an expandable prop-lock rod device to restrict movement of the slideout room while the vehicle is in motion.

The Lock Rod **must be released before extending the room** or damage to the coach will result.

NOTICE

Release and remove Slideout Prop-Lock Rod before attempting to extend slideout room. Damage to the vehicle will result if this is not done. Position and secure Prop-Lock before driving vehicle. See following instructions.

To Release Lock Rod

- Rotate the body of the cylinder to loosen and remove lock rod.



- Place T-shaped rod end against back side of slideout room flange
- Rotate cylinder body to loosen or tighten ends
- Place flat plate end against coach sidewall

Slideout Room Prop-Lock Rod

Typical view of forward end of retracted slideout room directly behind driver seat. Your model may differ in appearance.

To Secure Lock Rod

- Place the flat plate end of the lock rod against the outer wall of the coach about 6" down from the top edge of the forward end of the retracted slideout room (behind the driver seat in most cases).
- Swing the T-shaped end of the rod into place against the back side of slideout room flange (frame) as shown.
- Rotate the cylinder body to tighten the lock rod snugly. During vehicle stops, check and retighten as necessary.

Master Keylock

A master keylock switch is located near the power switch for the front slideout room. This keylock must be turned on to provide power to the slideout control switches.



Slideout Room Keylock

The key to turn the master keylock “off” is attached to the lock rod. This is to remind you that the rod is removed prior to turning the switch.



SLIDEOUT ROOM OPERATION - ELECTRIC

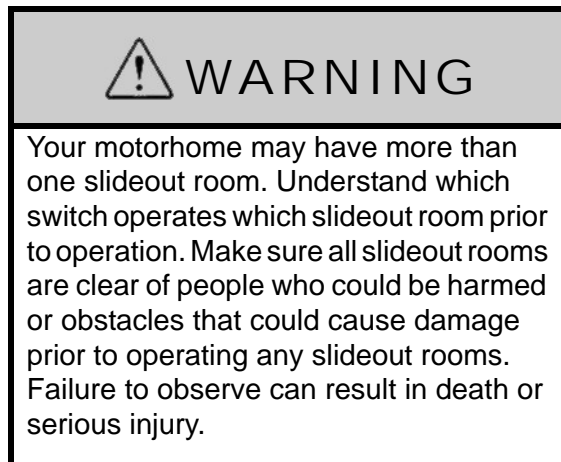

Slideout rooms provide a spacious living area at the push of a button.

Front slideout room switches (if equipped) are located either on the dash, near the main entry door, or near the Systems Monitor Panel. Location varies by model and floorplan.

Rear slideout switches (if equipped) are located on a wall near the slideout room or the Systems Monitor Panel. Location varies by model and floorplan.

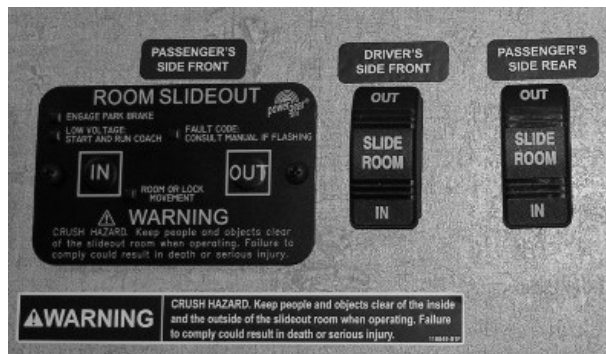

Slideout Switches

(Your coach may have one or more of these switches depending on model, options, and available equipment)
-Typical View



The slideout room system uses 12-volt DC motorized mechanisms with an electronic control system to provide smooth operation and positive weather seal.

NOTE: We recommend that you KEEP THE ENGINE RUNNING WHILE EXTENDING OR RETRACTING SLIDEOUT ROOMS so the engine alternator can provide maximum power for proper operation of the slideout mechanisms.

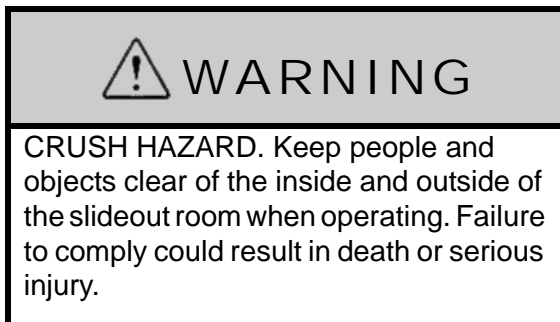

To Extend Slideout Room

Before Extending!

- Level the coach and set the Parking Brake.
- Release the travel lock or latch (if equipped) inside the coach. *See information at beginning of this section (if equipped).*
- Ensure exterior compartment doors are closed so that they will not interfere with slideout operation.
- Check inside and outside the vehicle to make sure that there are no people who could be harmed or obstacles that could cause damage due to room extension.

- If the slideout room has a couch or other furniture, make sure no people or pets are seated on them until the room has been fully extended.



Extend Procedure:

See “Before Extending!” before proceeding.

- Start the engine so the alternator can provide maximum power for proper operation of slideout mechanisms.
- Insert the Safety Lock key and turn to activate slideout room control switch.
- Press the Slideout Room “EXTEND/OUT” switch and hold until the room is fully extended, then release the switch.
- To stop extending the room during operation, release the button.
- Deactivate the slideout switch with the Safety Lock key.

To Retract Slideout Room

Before Retracting!

- Be sure the coach is level and the Parking Brake is set.
- Ensure exterior compartment doors are closed so that they will not interfere with slideout operation.
- Check inside and outside the vehicle to make sure that there are no people who could be harmed or obstacles that could cause damage due to room retraction.
- Stow all furniture extensions before retracting slideout rooms to avoid property damage.
- If the slideout room has a couch or other furniture, make sure no people or pets are seated on them until the room has been fully retracted.

- Remove all items from the coach living room floor and close cabinet doors and drawers. Be sure there are no items at the end of the bed, behind the driver seat, or protruding from compartments, which could be crushed or cause damage to floor covering or cabinets when the room is retracted.

NOTICE

Because the slideout roof is drawn into the interior of the coach when retracted, be sure there is no debris, such as excessive dirt, tree seeds, twigs, leaves, etc. on the roof before retracting.

If it has rained recently before you retract the slideout room, we recommend using the hydraulic leveling system (if equipped) to lean the coach and drain off any excess water possibly remaining on the roof before retracting. Lean the coach slightly to the left or right (depending on slideout location), by raising both right or left side jacks to let excess water flow away from the rooftop weather seal and toward the outside of the slideout roof. Retract the slideout slowly, starting and stopping to allow water to drain off room cover.

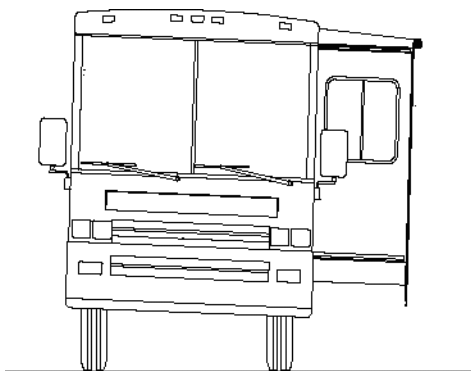

Retract Procedure:

See *“Before Retracting!”* before proceeding.

- Start the engine so the alternator can provide maximum power for proper operation of slideout mechanisms.

- Insert the Safety Lock key and turn to activate slideout room control switch.
- Press the Slideout Room “RETRACT/IN” switch and hold until the room is fully retracted, then release the switch.
- To stop retracting the room during operation, release the button.
- After the room is retracted, deactivate the slideout switch with the Safety Lock key, then refasten the travel lock or latch inside the coach (if equipped).

SLIDEOUT ROOM – EXTREME WEATHER PRECAUTION

Certain extreme weather conditions, such as heavy rains, heavy snow, and high winds, or any combination of these, could cause damage to the slideout room cover-awning (if equipped) or reduce effectiveness of the slideout room weather seals.



Slideout Cover-Awning
-Typical View

Also, freezing rain and snow can prevent the slideout cover-awning (if equipped) from closing and may cause damage to the cover-awning, slideout room, weather seals, and mechanisms.

To avoid potential damage, we recommend retracting your slideout room during extreme weather conditions.

**SLIDEOUT ROOM
TROUBLESHOOTING**

Battery Voltage or Circuit Breaker Problems

If the slideout room will not work:

- Turn the Chassis Battery Disconnect switch OFF and then ON again. This will, in many cases, reset power to the slideout system.
- The house battery may be low on charge. Plug in the external power cord (shoreline), start the engine, or start up the generator (if equipped). This may assist slideout room operation.
- The chassis battery may be low on charge. Press and Hold the Battery Boost switch (located on the dash) while pressing the interior slideout control switch. This momentarily connects the house batteries to assist in slideout room operation.
- The circuit breaker may be tripped. The circuit breaker, labeled “Slideout Power” is located on a panel on an interior wall of the passenger side storage compartment just behind or ahead of the entrance door.

Problems Retracting the Room

- Set the Park Brake if the Engage Park Brake light flashes while pressing the Retract (IN) button.

- Light will flash if park brake not set
- Light will flash fault code if system malfunctions



- Low Voltage Indicator

**Slideout Touchpad
(Located near monitor panel)
-Typical View**

If an error is detected on your slide system, the LED light on the control panel will blink an error code. If an error code appears, see the manufacturer’s user guide in your InfoCase to determine the problem. The error code must be cleared prior to operating the room. To clear the error and reset the system:

- If none of the “Battery Voltage or Circuit Breaker Problems” troubleshooting recommendations reset the system, remove the touchpad from the monitor panel (a screwdriver will be needed) and press and hold the RESET button (“Set Stops/Clear Fault”) located on the back of the touchpad for 5 seconds. The slideout is now ready to be retracted. Press IN on the touchpad to retract the room.
- Reinstall touchpad to the wall.
- Take your vehicle to an authorized service center for repair.

Before operating the room after an error has been detected, check for obvious faults such as obstructions prior to trying to operate the room again. If the error code appears again, the room will need to be retracted using either the manual retraction method or the fully manual method. Both methods listed below are intended as a means to retract the room to prepare the coach for travel to the nearest authorized service center.

Manual Mode

Manual Mode lets you individually move the two room arms by pressing the IN and OUT buttons on the touchpad. This mode can be used only if there is not a motor failure or full electrical system failure. To override the encoder and enter the Manual Mode, press and hold the RESET button (“Set Stops/Clear Fault”) located on the back of the touchpad until the two LEDs begin to flash.

While in the Manual Mode, each of the two room slide arms are activated by pressing and holding the IN and OUT buttons. The “OUT” button will retract the front arm. The “IN” button will retract the back arm. Both IN and OUT buttons may be held down at the same time to simultaneously activate both arms to retract the room. If one side of the room gets ahead of the other, release that button until the other arm catches up. The current limiting feature of the control still functions in the Manual Mode so each side can be fully retracted until it stops.

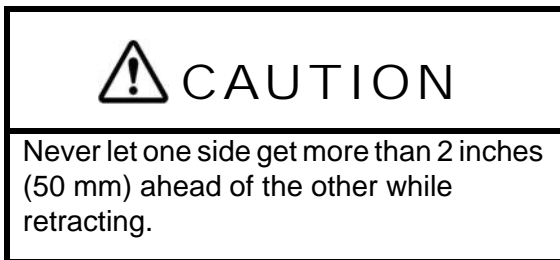

Once the room has been retracted, the control will return to the automatic mode after 60 seconds.

In the event of a total system failure where Manual Mode cannot be used, two crank handles may be used to retract or extend the room. See *Slideout Emergency Retraction - Electric* elsewhere in this section.

Problems Extending the Room

- Set the Park Brake if the Engage Park Brake light flashes while pressing the Extend (OUT) button.

- Light will flash if park brake not set
- Light will flash fault code if system malfunctions



- Low Voltage Indicator

Slideout Touchpad
(Located near monitor panel)
-Typical View

If an error is detected on your slide system, the LED light on the control panel will blink an error code. If an error code appears, see the manufacturer’s user guide in your InfoCase to determine the problem. The error code must be cleared prior to operating the room. To clear the error, perform the following steps (one at a time) to reset the system:

- If none of the “Battery Voltage or Circuit Breaker Problems” troubleshooting recommendations reset the system, remove the touchpad from the monitor panel (a screwdriver will be needed) and press and hold the RESET button (“Set Stops/Clear Fault”) located on the back of the touchpad for 5 seconds. The slideout is now ready to be extended. Press OUT on the touchpad to extend the room.
- If touchpad was removed, reinstall to the wall.
- Take your vehicle to an authorized service center for repair.

Further Information

See the slideout room operating guide included in your InfoCase for further instructions and troubleshooting information.

**SLIDEOUT EMERGENCY
RETRACTION (POWER GEAR®)**

-If Equipped

If the slideout mechanism is malfunctioning and the room will not retract using the interior control switch, you may need to access the motor/gear assembly and manually crank the room in to the travel position.

Your coach may be equipped with one or two motor/gearbox units (depending on model), which is located beneath the slideout room rail (or beneath each of the slideout room rails, if equipped with two motor/gearbox units).

Crank-In Procedure

1. Disengage the motor brake, which appears as a flat “square” protrusion on the protective boot at the end of the motor. Move the brake lever slightly - about 1/8 turn counter-clockwise, or to left when facing end of motor (repeat for motor at other end of room, if equipped).
2. Disconnect the motor power lead from the wiring harness (repeat for motor at other end of room, if equipped).
3. Use a 3/4” socket and ratchet wrench on the motor gearbox shaft to crank the room in to the travel position.

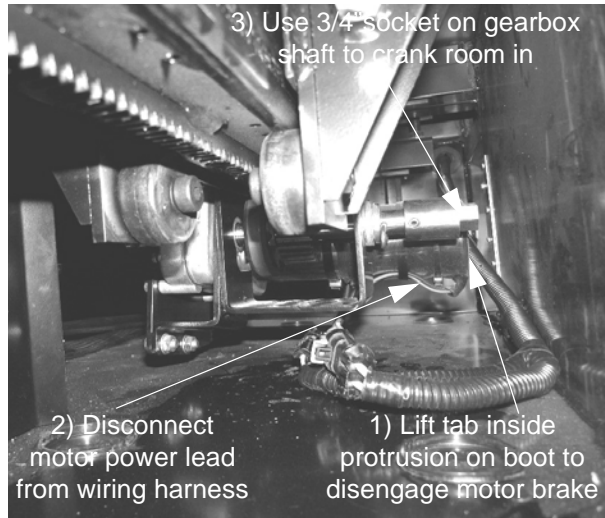

Slideout Motor/Gear Assembly
(Located beneath end of slideout room rail)
* Shown with slideout room extended
-Typical View

NOTE: If equipped with two motor/gearbox units, crank both sides of the room alternately and equally to avoid wedging the room.

If help is available, a second person (with a duplicate socket and ratchet) cranking the other end simultaneously will greatly speed up the process.

4. Crank the room(s) until it is just “snugged up.” Do not over-crank or you could damage the gear assembly.
5. While maintaining pressure on ratchet wrenches, re-engage the motor brake by moving lever clockwise slightly - or to right when facing end of motor (repeat for motor at other end of room, if equipped).
6. Reconnect motor power lead to wiring harness (repeat for motor at other end of room, if equipped).
7. Fasten slideout room travel latching device (if equipped) inside the coach before driving the vehicle.
8. See your dealer for service of the slideout mechanism before using again.

Further Information

See the Slideout Room operating guide included in your InfoCase for further instructions and troubleshooting information.

SLIDEOUT EMERGENCY RETRACTION (POWER GEAR®)

(Front Slideout Room)

-If Equipped

If the slideout mechanism is malfunctioning and the room will not retract using the interior control switch, you may need to access the motor/gear assembly and manually crank the room in to the travel position.

Your coach may be equipped with one or two motor/gearbox units (depending on model), which is located beneath the slideout room rail (or beneath each of the slideout room rails, if equipped with two motor/gearbox units).

Crank-In Procedure

1. Disengage the motor brake, which appears as a flat “square” protrusion on the protective boot at the end of the motor. Move the brake lever slightly – about 1/8 turn counter-clockwise, or to the left when facing end of motor (repeat for motor at other end of room, if equipped).
2. Disconnect the motor power lead from the wiring harness (repeat for motor at other end of room, if equipped).
3. Use a 3/4” socket and ratchet wrench on the motor gearbox shaft to crank the room in to the travel position.
4. Crank the room(s) until it is just “snugged up.” Do not overcrank or you could damage the gear assembly.
5. While maintaining pressure on ratchet wrenches, re-engage the motor brake by moving lever clockwise slightly - or to the right when facing end of motor (repeat for motor at other end of room, if equipped).
6. Reconnect motor power lead to wiring harness (repeat for motor at other end of room, if equipped).
7. Fasten slideout room travel latching device (if equipped) inside the coach before driving the vehicle.
8. See your dealer for service of the slideout mechanism before using again.

- 1) Lift tab inside protrusion on boot to disengage motor brake

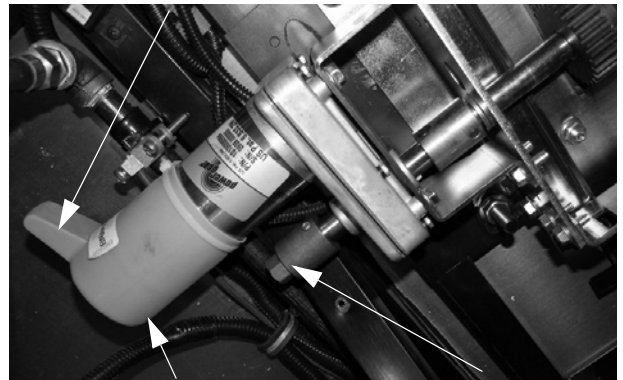

- 2) Disconnect motor power lead from wiring harness

- 3) Use 3/4” socket on gearbox shaft to crank room in

Front Slideout Motor/Gearbox Unit
(Located underneath coach below slideout)
-Typical View

NOTE: If equipped with two motor/gearbox units, crank both sides of the room alternately and equally to avoid wedging the room.

If help is available, a second person (with a duplicate socket and ratchet) cranking the other end simultaneously will greatly speed up the process.

Further Information

See the slideout manufacturer's user guide provided in your InfoCase for further instructions and troubleshooting information.

**SLIDEOUT EMERGENCY
RETRACTION - BEDROOM**

-If Equipped

If the slideout mechanism is malfunctioning and the room will not retract using the interior control switch, you may need to access the motor/gear assembly and manually crank the room in to the travel position.

The rear bedroom slideout has a motor/gearbox unit, which is located underneath the bed. Remove panel to access as shown in the following photo (if equipped).



Removable Panel (if equipped)
(Located underneath bed)
* Lift bed board to access
-Typical View

Crank-In Procedure

1. Disengage the motor brake, which appears as a flat "square" protrusion on the protective boot at the end of the motor. Move the brake lever slightly – about 1/8 turn counter-clockwise (to left when facing end of motor).
2. Disconnect the motor power lead from the wiring harness.

- 1) Lift tab inside protrusion on boot to disengage motor brake

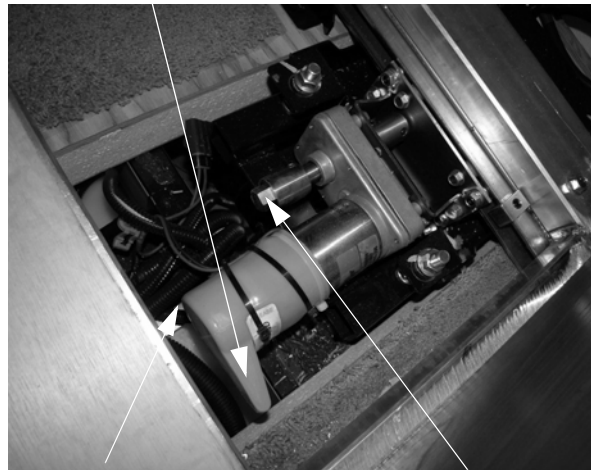

- 2) Disconnect motor power lead from wiring harness
- 3) Use 3/4" socket on gearbox shaft to crank room in

Rear Slideout Motor/Gearbox Unit
(Located underneath rear bed)
-Typical View

3. Use a 3/4" socket and ratchet wrench on the motor gearbox shaft to crank the room in.
4. Crank the room until it is just "snugged up." Do not overcrank or you could damage the gear assembly.
5. While maintaining pressure on ratchet wrenches, re-engage the motor brake by moving lever clockwise slightly (to right when facing end of motor).
6. Reconnect motor power lead to wiring harness.
7. Reinstall access panel (if equipped) and lower bed board.
8. Fasten slideout room travel latching device (if equipped) inside the coach before driving the vehicle.
9. See your dealer for service of the slideout mechanism before using again.

Further Information

See the slideout manufacturer's user guide provided in your InfoCase for further instructions and troubleshooting information.

GENERAL SLIDEOUT CARE

- Keep slideout room seals clean.
- Clean the floors inside the coach before retracting the slideout room to avoid floor scratches or carpet pile snags.
- Wipe outer slideout room seals occasionally with talc or 303 brand protectant for smooth, quiet operation.
- See your authorized dealer for regular maintenance and service of the slideout mechanism.

Slideout Room Seal Care and Maintenance

While most household cleaners work well for cleaning slideout room seals, certain chemical agents may cause the seals to degrade. Typically, 409® and Lysol® type products work well. Use a product, such as Armor All® to keep seals soft.

In addition, certain caulks and sealers may include chemicals that may adversely effect the performance of the seals. See your authorized dealer for caulks and sealers recommended for your coach.

LEVELING SYSTEM

-If Equipped

The Hydraulic Leveling System makes selecting a parking site easier and faster by reducing the effect of uneven ground.

Hydraulic jacks raise the affected low corners of the coach to make leveling “set up” faster and easier for you.

The Hydraulic Leveling System Control Panel is located near the dash area.



Leveling System Control Panel

See the **Leveling System Operation Guide** provided in your **InfoCase** for complete **operating instructions**. It also contains additional precautions, technical information, and instructions for manual operation if a system failure occurs.

NOTE: When parking at an uneven site, always park the front of the motorhome to the downhill side. This allows you to level by raising the front end rather than the rear. Since only the rear wheels are locked while in PARK, raising either one or both of the rear wheels off the ground could allow the vehicle to roll off the jacks.



 **WARNING**

- Keep all people clear of the coach while the leveling system is operating.
- When extending the rear stabilizers, do not lift the wheels beyond ground contact. This makes it possible for the vehicle to roll unexpectedly forward (or backward) off the jacks. This could cause severe injury or death.
- Do not use the levelers on icy or slick surfaces on which the foot pads may slip.
- Do not use leveling jacks to support the vehicle for service or tire changing.
- Do not use the leveler as an emergency brake. They are not designed for any type of vehicle braking purpose.
- Never check for hydraulic fluid leaks using your hands and/or any other body part. The leaking fluid is under pressure and is capable of cutting and penetrating your skin, resulting in severe injury.

Jacks Down Light

The “Jacks Down” reminder is intended to warn you to retract your Leveling Jacks before moving the vehicle. The light will come on briefly and a chime will sound when the ignition key is turned to the On or Run positions if the jacks are down.



“Jacks Down” Light
(Located on dash)
-Typical View

NOTICE

- Do not try to drive vehicle unless “TRAVEL” light is glowing with ignition switch on.
- Do not try to drive the vehicle until the air suspension system has built up sufficient pressure if you have used the coach leveling system or have used the DUMP button to manually exhaust the air suspension system.
- Do not rely only upon the warning lights to indicate when jacks are up. It is the owner’s responsibility to check that all jacks are up before moving the coach.

NOTE: If the Leveling Jacks should fail to retract, see the “Troubleshooting” and emergency operation instructions in the Leveling System Operation Guide provided in your InfoCase.

In The Event Of Accidental Jack Extension

1. Bring the vehicle to a safe and complete stop as soon as possible.
2. Turn the Leveling Systems Power switch ON and press the “Auto Store” switch.
3. Visually inspect the vehicle undercarriage for any problems.

4. See the Leveling System Operation Guide supplied in your InfoCase for troubleshooting instructions or operating the Leveling System if jacks fail to retract or any other functions fail.

Further Information

See the manufacturer's operation guide provided in your InfoCase for complete operating instructions, safety precautions, and troubleshooting tips.

CHECKING HYDRAULIC OIL LEVEL

See the Leveling System Operation Guide provided in your InfoCase for complete maintenance instructions and information.

All maintenance should be done as part of the normal servicing of the coach.

The hydraulic oil level should be checked when the vehicle is first purchased, and then twice a year - or more often if an oil leak develops in the system.

The hydraulic pump/reservoir is located inside a compartment behind the driver side front tire. In certain models, an access panel must be removed to access the pump/reservoir.

NOTE: To get an accurate indication of oil level, Leveling Jacks and Slideout Rooms must be in the retracted (IN) position.

Checking Hydraulic Oil Level

The hydraulic oil level is checked visually by inspecting the hydraulic oil reservoir. Always keep the hydraulic oil level full (up to the FILL line on the reservoir).

NOTE: Always clean away any dirt and debris from the top of the reservoir before removing the breather cap to avoid entry of debris and contamination of hydraulic oil in the reservoir, which could lead to pump failure or other problems.



Hydraulic Oil Reservoir
-Typical View

NOTE: Overfilling the hydraulic reservoir can cause leakage of oil through the breather cap.

Hydraulic Fluid Recommendation

Dexron® II or Mercon® automatic transmission fluid is recommended for use in your Leveling System.

DO NOT USE brake fluid or hydraulic jack oil, which can damage the seals and cause leaks.

SECTION 11 - MAINTENANCE AND STORAGE

SEALANTS – INSPECTION AND GENERAL INFORMATION

Water is a recreational vehicle's worst enemy when it is allowed to enter where it is not intended. Sealants perform a very important function and should be inspected closely and maintained regularly. Winnebago Industries® utilizes many different types of sealants. Refer to the "Sealants Call-Out Sheet" provided in your InfoCase for further information.

Sealants, in general, do not have "set" lifetimes. Varying environmental factors affect the pliability and adhesiveness of sealants. You or your dealer must:

- Inspect all sealants, a minimum of every six months.
- Inspect the moldings, windows, clearance lights, exterior compartment doors, and all their attachments.
- Also, inspect weather seals around entrance door, etc., and if necessary, have a dealer replace them immediately.
- Check for cracks, voids, gaps, breaks, adhesion, and any sign of physical deterioration.

NOTE: Proper sealant inspection includes not just visual observation but running a finger along sealant seams to verify proper adhesion to the surface. Any loosened areas must be replaced.

- Have the sealant replaced if you notice any of the above. Your local Winnebago Industries dealer has the correct and necessary parts and experience to help you maintain your sealants. See "Sealants Call-Out Sheet" provided in your InfoCase.
- Always use the same type sealant that was removed.
- Immediately have dealership check moldings, windows, and exterior attachments for leak source if you notice water inside of unit.

NOTICE

Sealants must be inspected every 6 months and replaced if necessary.

ROOF

WARNING

Stay off roof. Roof surface may be slippery. Falling could result in death or serious injury.

The roof is made of Thermo-Panel materials like the walls and floor. It will support the weight of an average adult for periodic maintenance or repair of the roof or roof mounted components.

Walking or working on the roof should be left to qualified service personnel using proper safety equipment in a safe environment. You should only walk or work on the roof if you are qualified and have created a safe environment.

For your safety, it is not recommended that you store or carry items on the roof.

Always have damage to the roof area repaired immediately. Damaged or detached sealant around the vents, air conditioner, body-to-roof seams, etc., should also receive immediate attention. Delaying these repairs may allow water leakage and result in damage to interior ceiling and body panels, upholstery, etc., which is not covered by the limited warranty (see *Section 1 - Introduction*).

UNDERCARRIAGE

Buildup of mud and dirt under the body of the vehicle can cause damaging rust or corrosion on steel or aluminum parts and can add needless

weight to the vehicle. This, in effect, reduces the amount of cargo you can carry and remain within GVWR and GAWR limits.

Corrosive materials, such as those used for ice and snow removal and dust control, can also accumulate on the underside of a vehicle. These materials should be removed by flushing the undercarriage regularly with water, especially horizontal surfaces, cavities, and other areas where mud and other deposits may collect.

EXTERIOR AUTOMOTIVE PAINT FINISH

–If Equipped

The body of your coach is fully or partially finished with the highest quality automotive paint and clearcoat. Follow these precautions to keep the finish on your coach looking its best and preserve maximum gloss and durability.

Parking

- **Avoid parking under trees** – When this happens you should rinse the bird droppings and tree sap off as soon as possible. Tree sap is a form of sugar and will dissolve after a couple of rinses. Bird droppings can eat into a painted surface if left unattended and need removed as soon as possible. Lukewarm soapy water can help speed up the cleaning process.
- **Avoid parking near salt spray** – When this happens you need to rinse off the salt mineral residue to minimize the corrosiveness of the salt.
- **Avoid parking near factories with heavy smoke or industrial fallout** – Industrial fallout can eat into your coaches finish when dew or rain mixes with it to create nitric or sulfuric acid that gets magnified by the intensity of the sun. As the water evaporates the acid becomes more powerful and attacks the painted surface.
Rinsing and washing the surface helps remove the fallout and neutralize the acid. After the

initial 60-day cure stage, a coat of wax or polish can help protect the surface from these types of contaminants.

- **Do not scrape ice or snow from the painted surface.** Brush off gently with a soft-bristled ‘snow brush’ – avoid being forceful with the brush.
If brush scratches show after the motorhome thaws out, it may be possible to remove them by hand waxing with a silicone-free liquid wax.

Driving

- Avoid driving on gravel roads.
- Rinse off bugs and bird droppings with water daily.
- Antifreeze, fuel or windshield/window solutions spilled on the painted surface should be rinsed off immediately with water and allowed to air dry. Wiping dry with a towel may create fine scratches due to the solvent nature of these types of fluids.
- Fuel cannot be diluted and dissipated with water. It must be removed with a mineral spirit type cleaner (such as *SEAFOAM Bugs-B-Gone* or equivalent) or a silicone-free spray wax and micro fiber cloth to remove the stain left by fuels.

NOTE: When driving in wintry conditions the road surface may be covered with heavy salts or small rocks to improve road traction. These types of road conditions can cause undue surface damage to your RV. Please refrain from driving in these conditions

Washing

- Commercial vehicle wash facilities should be strictly avoided! They will scratch your RV!
This is because truck style wash centers have high-pressure wands that emit higher than necessary water pressures and the brushes are very aggressive. Most truck wash brushes are made from a heavy plastic for durability and are under heavy pressure. They are designed

to clean heavy road films on semi trailers and are often dirty. They are not designed for custom painted RV's and they will scratch the clearcoat finish. Many times these scratches can penetrate the clearcoat finish causing delamination and/or other paint related issues that are not covered under warranty.

- Wash your RV with cool or lukewarm water using a mild soap— such as a baby shampoo— that does not contain bleach solution. Most auto stores offer car wash detailing soaps that are similar and do not have bleach in the formulation (*such as Meguiars #62*).
- Never use a bristled brush or broom to wash the painted surface. This will cause scratches in the finish. Use a clean lamb's wool mitt, sponge or microfiber mitt (or mop) to wash your unit.
- Be sure your cloth or applicator is clean. A dirty applicator can scratch your RV.

Washing Procedure

- Rinse area to be washed with cold water to remove surface residue. Make sure you are not in direct sunlight.
- With area to be washed still wet from the rinse, use the recommended soapy mixture to clean the area. Use care to make sure that a clean lambs wool mitt, sponge or Microfiber mitt or mop is used to apply soapy water.
- Rinse washed area before soap evaporates.
- Dry the rinsed area before the water evaporates.

NOTE: Avoid aiming water flow from a hose or spray from high pressure washing equipment into any appliance intake because damage or difficulty in operating appliances may occur.

- After washing the coach, carefully inspect sealant around window frames and vents and any other joints that may have loosened or separated. See “Sealants” at the beginning of this section for details.

Bug Removal

- Rinse the loose debris off with water and allow the remaining residues to soak and soften. Use soap and water to wash the residue, then rinse. (You may wish to repeat and leave soap on longer than normal to help with softening hardened residue.)
- For more stubborn areas use an ammonia based glass cleaner followed by a warm soapy water wash and a rinse.
- Remember to use micro-fiber towels during this process to help avoid scratches.
- If this does not work, as a last resort, use a bug removal product (*like SEAFOAM Bugs-B-Gone or equivalent*) in a shady area and follow the directions on label.

Polishing and/or Waxing

NOTE: When your coach is new or has been repainted for any reason, no polish or wax should be applied to the finish until after a 60-day cure cycle at temperatures higher than 60 degrees for 60 days. Failure to observe this precaution could void your paint warranty.

- We recommend a silicone-free polish (*such as Meguiars M8132 Hand Polish or Machine Polish*) with an orbital machine and terry cloth applicator.
- Liquid waxes are easier to apply and bring to a gloss with fewer residues.
- Avoid paste waxes. They sometimes have fillers and additives that give a very short term result. Stay away from silicones in polishes and soaps.
- Buffing Compounds remove some of the mil film of the clearcoat, so we recommend that only professionals or very experienced users apply this type of product.

Inspection

A motorhome exterior is subjected to many physical forces and environmental conditions. While the coach is parked, it is exposed to climate and weather extremes and other environmental conditions. While in operation, it

is subjected to various twisting and flexing forces caused by routine cornering and turning, and by uneven road surfaces, such as bumps, potholes, railroad tracks and parking lot entrances.

Inspect the exterior fiberglass shell periodically for cracks which may represent a threat to the integrity of the fiberglass.

Minute cracks in the surface, commonly called "spider cracks" or "hairline cracks" caused by normal flexing of the fiberglass exterior are normal and typically pose no threat to the integrity of the vehicle other than appearance.

However, if a crack has opened up and the weave of the cloth is visible, this does represent a threat to the integrity of the fiberglass and must be repaired or covered as quickly as possible to avoid penetration by moisture, especially in freezing climates.

If the fiberglass has been damaged and contains cracks, tears or holes, use plastic sheeting and duct tape, if necessary, to prevent moisture from damaging the sidewall material or the interior of the coach.

EXTERIOR GRAPHIC CARE

The pressure-sensitive graphics on your vehicle require very little maintenance. In order to allow the graphics to have the longest life possible, the following steps should be taken.

- Wash graphics with plain soap and water or any car wash detergent. Rinse thoroughly.
- High pressure water spray may loosen or damage graphics. Keep spray nozzle at least 1 1/2 feet from the edge of the graphics.
- Test any cleaning solution on a small section of graphic before using.
- Never use aromatic solvents such as acetone, M.E.K., toluene, paint thinner or lacquer thinner on graphics. Solvents may soften the vinyl and smear colors.
- Gasoline or other fuels spilled on graphics should be rinsed off immediately with water.
- Do not apply paint or clearcoat over the graphics.

- Do not apply wax over the graphics, especially wax containing petroleum distillates. Wax that has dried along the edge of a graphic can be removed with cotton swabs after softening it with isopropyl alcohol. Rinse area thoroughly after cleaning.

PLASTIC PARTS - CLEANING

Many parts in your vehicle, such as the dash, exterior light lenses, and certain exterior body panels are made of high-impact plastic materials that can be damaged by wiping with solvents or improper cleaning products.

Always try cleaning plastic parts with the mildest cleaners first and work your way up to stronger cleaning products. Use the following cautionary lists as a guide when selecting cleaning products to use on plastic parts.

NOTICE

Do not use citrus-based cleaners on polycarbonate finishes. Citric compounds will damage the high-gloss surface, causing it to appear dull or "flat". Always test a cleaning product on a hidden area to be sure it will not cause damage to the appearance of the part.

Here is a list of mild cleaners that **may be used safely**:

- Car washing soap and water
- Glass cleaners *without ammonia*
- Mineral oil
- Multipurpose cleaners (such as Fantastik[®], Formula 409[®], etc.)

The following products, compounds, or solvents must be **wiped off immediately** to avoid damage:

- Ammonia
- Brake fluid
- Bathroom basin, tub, and tile cleaners
- Chlorine

- Ethyl alcohol
- Isopropyl (rubbing) alcohol
- Kerosene or gasoline
- Naphthalene
- Pine-type household cleaners

Do not use cleaners containing the following products, compounds, or solvents. These products **will damage** the finish.

- Acetic acid
- Acetone (nail polish remover)
- Aromatic solvents (lacquer thinners)
- Benzene
- Butyl alcohol

INTERIOR SOFT GOODS

We recommend a weekly routine of vacuuming all fabrics and carpet throughout the motorhome to prevent an accumulation of dirt, which can detract from the appearance and shorten the life of carpet and fabrics.

Fabric Upholstery

Some fabrics used in this motorhome may contain fire retardant and lightfastness additives, which can be damaged by use of improper cleaning products. Some water-based household cleaning products are not formulated for use on fabrics and may cause excessive shrinkage or fading. Always test any cleaning product on a hidden area of fabric before using on visible areas. For best results, fabric cleaning should be referred to a professional carpet and upholstery cleaner.

NOTE: To minimize fading of upholstery, carpets and other interior fabrics caused by excessive sunlight, the drapes, blinds, or shades should be closed when the motorhome is parked for an extended period of time.



WARNING

When cleaning upholstery and fabric, do not use lacquer thinner, nail polish remover, laundry soaps, or bleach. Never use carbon tetrachloride, gasoline, or naphthalene for any cleaning purpose. These materials may cause damage to the material being cleaned and most are highly flammable, posing risk of injury due to fire.

Ultraleather™ Leather-Like Upholstery

Ultraleather synthetic leather fabric material has the luxurious look and feel of the finest European calfskin, with the durability and resistance to soils and stains of vinyl fabrics. It is also tougher than real calfskin and has superior resistance to punctures, snags, and rips.

For most soils and stains, the fabric manufacturer recommends spot treatment with a solution of water and Tide® brand laundry detergent or equivalent. More stubborn stains may be treated with a water-based multipurpose cleaner/degreaser such as Simple Green® or equivalent. Solvent cleaners such as nail polish remover or other aromatic solvents are not recommended.

Care Instructions

- Spot clean with mild soap and water.
- Air dry or, if desired, dry quickly using a hair dryer on warm setting - not hot.
- For stubborn stains, use cleaner-degreaser.

UltraLeather Cleaning Chart		
Type of Stain	Detergent/ Water	Cleaner/ Degreaser
Coffee, Tea	◆	
Red Wine, Liquor	◆	
Cola, Soft Drinks	◆	
Milk	◆	
Ketchup	◆	
Steak/Soy Sauce	◆	
Mayonnaise, Butter	◆	◆
Salad Oil	◆	◆
Chocolate	◆	◆
Cosmetic Makeup	◆	◆
Lipstick	◆	◆
Face Cream	◆	◆
Suntan Oil/Lotion	◆	◆
Shoe Polish	◆	◆
Urine	◆	◆
Machine Oil		◆

Vinyl Fabrics (including ceiling)

Vinyl should be cleaned with a soft, damp cloth, and a mild detergent only. Do not use solvents. Solvents may damage the surface of the vinyl.

**Draperies, Curtains, and
Bedspreads**

These items may be woven from a variety of fabrics. We recommend that these be professionally dry cleaned only. A five percent shrinkage may occur when you have these items dry cleaned.

General Stains

As with any stain or contamination, the quick response is the best, especially when done in conjunction with the proper cleaner for the type of stain.

CEILING FABRIC CARE

-If Equipped

While using your coach, your ceiling fabric may become soiled and require spot cleaning from time to time.

These materials are made from polypropylene or polyester synthetic fibers, so they clean very well with virtually no damage to the color or fabric itself.

Most commercially available carpet and upholstery cleaners will do an excellent job removing stains. From time to time, additional cleaning methods may need to be used to remove stubborn or difficult stains.

The following cleaning chart is provided as a guideline for care and cleaning of ceiling fabrics used in your coach.

CEILING FABRIC STAIN REMOVAL		
Type of Stain	Cleaning Agent	How to Remove
Mustard	Dry-Clean Solvent	Scrub-Soak-Blot Dry
Ketchup*	High Strength Detergent	Scrub-Soak-Blot Dry
Coffee*	High Strength Detergent	Scrub-Soak-Blot Dry
Chocolate*	Detergent	Scrub-Soak-Blot Dry
Tea	High Strength Detergent	Scrub-Soak-Blot Dry
Chewing Gum	Dry-Clean Solvent	Scrub-Soak-Blot Dry
Oil	High Strength Detergent	Scrub-Soak-Blot Dry
Grease	High Strength Detergent/Degreaser	Scrub-Soak-Blot Dry
Tar/Asphalt	K-1 Kerosene/Thinner	Scrub-Soak-Blot Dry
Wax	Detergent	Hot Iron on Detergent-Soaked Towel/Cloth
Rust	Rust Remover	Scrub-Soak-Blot Dry
Dirt*	Detergent	Scrub-Soak-Blot Dry
Lipstick	Dry-Clean Solvent	Soak-Blot Dry
Nail Polish	Dry-Clean Solvent	Soak-Blot Dry
Shoe Polish	Dry-Clean Solvent	Soak-Blot Dry
Crayon	High Strength Detergent	Scrub-Soak-Blot Dry
Marker (indelible)	Detergent	Scrub-Soak-Blot Dry
Ink (Ballpoint Pen)	Dry-Clean Solvent	Soak-Blot Dry
Pencil Lead (Graphite)	Detergent	Scrub-Rinse-Blot Dry
Vomit*	High Strength Detergent	Scrub-Rinse-Blot Dry-Deodorize w/Vinegar
Urine*	High Strength Detergent	Scrub-Rinse-Blot Dry-Deodorize w/Vinegar
Blood*	High Strength Detergent	Scrub-Rinse-Blot Dry
Excrement*	High Strength Detergent	Scrub-Rinse-Blot Dry-Deodorize w/Vinegar

NOTE: In many cases listed above, repeated steps may be required to fully extract contaminant from material. Items listed above with () may also be removed through steam extraction method by a professional cleaner or service. Always check to see that the cleaner used will not cause damage to the material or fabric by testing on an area out of sight.*

Water Stains

Water stains should be cleaned with a mixture of 1/4 cup of white powdered or clear liquid laundry detergent (no coloring) in a bucket of warm water. Working with a clean sponge or white cloth, start from the outside of the stain and work your way to the center. This method will keep the stain from spreading. Do not over saturate as this may cause delamination. No need to scrub, simply rub lightly or dab the stain.

You may have to repeat this procedure more than once to achieve desired results. Finish up with clean water, using the same method, and blot dry.

Steam cleaning is also an option. Again, take care not to over-saturate the material.

CABINETRY – CLEANING

Wooden items may be cleaned with a soft cloth and a good quality wood finish cleaning product.

Vinyl simulated wood panels may be cleaned with a mild, water-based cleaner and a soft cloth. Do not use solvents on vinyl wood panels.

NOTE: Many cabinetry and furniture items throughout this motorhome are constructed either partially or completely of real hardwoods. Because of natural variations in woodgrain density, slight differences in stain hue may exist between one item and another. This is the distinctive character and beauty of real wood.

TABLES AND COUNTERTOPS

Work surfaces are covered with a plastic or thermo-formed laminate that resists solvents, stains, and abrasions. A coat of furniture wax applied to these surfaces on the counters and table will help preserve their beauty and make cleaning easier. Always clean the surface before applying wax.

STAINLESS STEEL APPLIANCES

-If Equipped

Care and Maintenance

You can easily maintain the beauty of your stainless steel appliances with little effort, under most circumstances, by performing the following recommendations.

Typically, excellent results can be obtained by washing stainless steel with mild dishwashing liquid and hot water, followed by rinsing

thoroughly and drying with a soft cloth. Drying is particularly important if the tap water is very hard and leaves scale deposits.

Stainless steel does not deteriorate due to frequent cleaning, so proper cleaning can be performed whenever necessary. For more stubborn stains, perform the following procedures for your stainless steel appliances to start shining again.

Scale

To remove scale left by water, simply use a multipurpose cream detergent and a soft cloth. Thicker scale may be removed by generously applying 25% vinegar and hot water solution to the stain. Rinse thoroughly with a sodium bicarbonate and water solution, then follow up by rinsing with water. Clean carefully.

Oil and Grease Stains

To remove oil and grease stains, use a mild dishwashing liquid and hot water. Rinse thoroughly with clean water and dry with a soft cloth. For more stubborn stains, ethyl alcohol, acetone, or another non-halogenated solvent may be used with care.

Stubborn Dirt and Burnt Grease

Use a multipurpose cream detergent and a soft cloth.

Coffee and Tea Stains

Prepare a sodium bicarbonate solution and hot water. Apply generously to stain and let sit for 15 minutes. Rinse thoroughly and dry with a soft cloth.

Rust Stains

Apply a multipurpose cream detergent and rub delicately with a soft cloth. If stain persists, it may be necessary to apply a stainless steel-specific product.

Fingerprints

Use a mild dishwashing liquid and warm water. Rub delicately with a soft cloth. Window cleaner may also be used.

Scratches

Apply a stainless steel-specific detergent/polisher and buff with a soft cloth.

Important “Don’ts”

- Do not use hydrochloric acid or any other detergents containing chlorides on stainless steel.
- Do not use abrasive powder detergents that could ruin the surface finish.
- Do not use wool, abrasive brushes, or tools that have previously cleaned other metals, because as well as scratching the surface, they can generate contamination and unattractive stains.
- Do not use silver cleaners.

GALLEY SINK

Acrylic

Care and Cleaning Instructions

The galley sink has been designed and engineered to resist scratches and should not stain under normal household use if used properly.

To keep this product looking its best, we recommend that you take a few easy precautions.

General Cleaning

Clean often with hot water and soap. If a cleanser is necessary, make sure the product is recommended for use on plastics.

Avoid harsh abrasive cleaners, ammonia, or citric-based products as discoloration may result.

Rinse all food, beverage, or cosmetic residue from the sink as soon as possible. Some residues, if left to sit in the sink, may require the use of detergent or a mild liquid or gel-type kitchen surface cleaner.

If acids or medicine spill on the surface, wash the spills immediately.

Hard-to-Remove Food and Beverage Residue

For most stubborn stains, fill the sink about one quarter full with a 50/50 solution of bleach and water. After 10 or 15 minutes of soaking, drain solution from the sink as you rinse both sides and bottom.

NOTE: Do not use steel wool or metal scouring pads.

Marks or Discoloration

A color-matched automotive scratch remover compound may be used to remove stubborn marks or discoloration. Always follow label directions.

NOTE: Improper use may damage this product and void the warranty.

RANGE AND REFRIGERATOR

For care and appearance maintenance of the range and refrigerator, refer to the appliance manufacturer’s operation and maintenance manuals included in your InfoCase.

VINYL FLOORING

Care and Maintenance

You can easily maintain the beauty of your vinyl flooring with little effort, by following these recommendations:

- Sweep or vacuum floor daily (use a vacuum without a beater bar head.) Remove loose dirt with a soft brush or Swiffer® type product.
- For more intense cleaning, use a non-abrasive cleanser, such as Mr. Clean®. Rinse with clean water.

NOTE: Floor cleaners containing waxes, brighteners, or gloss agents are not recommended.

- Regular cleaning with solvent-based chemicals may adversely affect the topcoat performance.
- Do not use undiluted bleach or leave a dilution of bleach on the floor for longer than one hour.

Maintenance Tips

- Install protection (such as pads or casters) on furniture with legs or sharp edges. This protection should not contain bitumen, which may cause brown stains.

NOTE: Faulty pads and casters should be removed and replaced.

- Burning cigarettes and matches can cause damage to the flooring.
- Use doormats (that do not contain bitumen) to keep out most of the dirt and dust.
- Remove spills immediately with a damp cloth, followed by rinsing with clean water.
- The use of stiletto heels is not recommended, as they may cause permanent damage to the flooring.
- Protect flooring from prolonged direct sunlight exposure.

Treatment of Stains

Acids, alkali, alcoholic beverages, coffee, soft drinks, ketchup, fruit, fruit juices, food, vegetables, mustard, ink, and iodine:

- Remove the stain with lukewarm water and a cloth or sponge. If necessary, clean with a soft nylon pad and non-abrasive mild detergent or resilient floor cleaner.

Heel marks:

- Clean as soon as possible with a soft nylon pad and non-abrasive mild detergent or resilient floor cleaner.

Asphalt, candle grease, chewing gum, fat, oil, tar, and shoe polish:

- Gently remove with a blunt instrument and treat with a soft nylon pad and non-abrasive floor cleaner.

Lacquer and nail polish:

- Remove as soon as possible. Do not allow to dry. If necessary, apply nail polish thinner (sparingly) to remove any residue.

Corrosion, paint, and grass stains:

- Treat as soon as possible with a soft nylon pad and non-abrasive mild detergent or resilient floor cleaner.

Varnish, oil paint, and solvents:

- Blot up as soon as possible. Do not rub, as this will only spread material further across the surface. Carefully treat with a mild cleanser. When dry, carefully peel the stain off. MEK may be used sparingly, if necessary. Rinse immediately with clean water.

Pet stains:

- Treat with lukewarm water. If stain remains visible, clean with a soft nylon pad and non-abrasive resilient floor cleaner.

BATHROOM

Toilet

For instructions on the care of your toilet, refer to the information in your InfoCase.

Tub and Shower Walls

The tub and shower walls in the bathroom should be cleaned with mild soap and warm water. Do not use an abrasive cleaner on the shower walls and tub, as scratching and discoloration may occur. Stubborn stains may be removed with an automotive-type cleanser.

Lavatory Sink

The lavatory sink is made of the same material as the galley sink. See Galley Sink - Care and Cleaning Instructions.

DOORS AND WINDOWS

Windows may be periodically cleaned with a good quality glass cleaner or mild soap solution using a soft cloth.

Use care when removing ice or frost from the windows. Always use a plastic ice scraper, never one made of metal. Use care when removing ice from the mirrors to protect the reflective surfaces.

Door locks and hinges should be lubricated periodically with powdered graphite to ensure trouble-free operation and to protect against freeze-up.

VEHICLE STORAGE - PREPARATION

Properly preparing your vehicle for storage will lessen the possibility of damage to your vehicle. Prepare the motorhome for vacancy just as you would if you were leaving your house for an extended period.

Clean and Prep Coach for Storage

1. Turn off the propane gas tank.
2. Turn the electronic thermostat switch OFF.
3. **Remove all foods and items that may cause odors from cabinets and refrigerator.**
4. Clean and defrost the refrigerator. Prop the door open slightly to allow any odors to dissipate. Place an open box of baking soda inside the refrigerator to help absorb odors.
5. **Fully charge the batteries. Batteries must have at least 80% charge to survive freezing temperatures and long period of non-use.** We recommend that you connect a battery charger or plug in the shoreline once a month during long-term storage periods to maintain battery charge and to avoid sulfating. If connecting a charger directly to batteries, turn the House/Coach Battery Disconnect switch off to avoid electrical arcing when attaching and detaching charge clamps.

NOTE: We do not recommend leaving the shoreline plugged in continuously during storage.

6. After charging batteries, turn the House/Coach Battery and Chassis Battery Disconnect switches off to disconnect the batteries and avoid parasitic* drain.

** Parasitic battery drain is the gradual drain by items connected directly to battery power such as clocks, radio memory, and the engine computer.*
7. Have the vehicle chassis completely serviced and lubricated. Be sure radiator antifreeze protection level is sufficient for the lowest anticipated temperatures.
8. Wash and wax the coach.

9. Inspect all seams and seals around doors, windows, vents, and any other joints. Replace or repair any that are damaged. Sealing materials and compounds can be purchased from your dealer. Badly damaged weather seals may need to be replaced by your dealer.
10. Close all windows and roof vents. Protect all appliance vent openings from contamination by animals or insects (e.g. bird nest, wasp nests, etc.)
11. Lubricate all door hinges and locks.
12. Clean the interior of the coach. Dirt and stains are more easily removed when fresh.

If you are storing your vehicle through the winter or in cold climates, extra preparations must be made to protect equipment and systems that can be damaged by freezing temperatures. See "Winterizing Procedure" in *Section 7 - Plumbing*.

VEHICLE STORAGE - REMOVAL

1. Completely air out the motorhome.
2. Have the entire LP gas system checked for leaks.
3. Check window operation.
4. Check cabinet and door hinges. Lubricate with penetrating oil, if necessary.
5. Close all faucets and drain valves that are open.
6. Add a few gallons of water to the fresh water tank and turn on the water pump to check for leaks, especially at fittings.
7. Open all faucets in turn to release trapped air and check to be sure faucet washers have not hardened during storage.
8. Sanitize the water system as outlined under *Disinfecting the Fresh Water System* in the Plumbing section, then flush the waterlines thoroughly with fresh water.
9. After flushing fresh waterlines, install a new water filter cartridge on the galley sink water filter and/or full-coach water filtration system (if equipped). See appropriate filter installation instructions in Plumbing section.

NOTE: Always purge a new filter with clean running water before using. See filter manufacturer's directions included with the filter cartridge.

10. Check the toilet for proper operation.
11. Add water to the holding tank using the toilet flush pedal and galley sink faucet. Check to be sure dump valves seal tightly.
12. Check around all appliances for obstructions and ensure that all vent openings are clear.
13. Start refrigerator and check for proper cooling.
14. Clean wall and counter surfaces.
15. Replace batteries, if necessary, and check out electrical system to make sure all lights and electrical components operate.
16. Check tires for proper cold inflation pressure. See "Vehicle Certification Label" in *Section I - Introduction*.
17. After washing accumulated winter grime from the vehicle, it is important to carefully inspect the seams and sealants for separation or cracks that may have appeared around the window frames, vents, and any other joints. See *Sealants – Inspection and General Information* at the beginning of this section. Resealing is quite simple and the material is quickly and easily applied. Appropriate compounds are available from your dealer. See the *Sealants – Recommended Application* page in the Supplement Manual provided in your InfoCase.
Also inspect weather seals around doors, etc., and if necessary, have a dealer replace immediately.

CHASSIS SERVICE AND MAINTENANCE

Consult the appropriate sections in your chassis manual for specific information regarding operating safety, service recommendations, and maintenance schedules for the chassis section of your vehicle.

COACH MAINTENANCE CHART

These recommendations apply for normal recreational use. Heavy duty or full-time use may require more frequent maintenance intervals.

Always use specified sections or manufacturer's guide for further information and instructions.	Before Each Use	Weekly	Monthly	Every 3 Months	Every 6 Months	Every Year	As Necessary
Propane Gas System							
Have propane gas system checked for leaks						◆	◆
Pressure Regulator - inspect and adjust if needed						◆	
Check propane tank condition, mounting, and fittings						◆	
Electrical System							
Check Battery Condition Meter	◆						
Check battery fluid level and connections			◆				
Check 12V fuses and 120V breakers							◆
Check GFCI receptacles			◆				
Generator							
Visually inspect generator and compartment	◆						
See generator manufacturer's maintenance guide							◆
Plumbing System							
Sanitize plumbing system							◆
Winterize plumbing system							◆
Clean water pump strainer filter						◆	◆
Slideout & Leveling System							
Check and adjust							◆
Check hydraulic oil level			◆				◆
Check hydraulic lines (routing, leaks, etc.)						◆	
Inspect slideout room seals (bulb seals), clean as necessary				◆			
Check and inspect electric slideout lock drain line(s)							◆
Exterior							
Clean roof				◆			◆
Clean sidewalls			◆				◆
Clean windows							◆
Flush underside of vehicle				◆			◆

**SECTION 11 -
MAINTENANCE AND STORAGE**



COACH MAINTENANCE CHART

These recommendations apply for normal recreational use. Heavy duty or full-time use may require more frequent maintenance intervals.

Always use specified sections or manufacturer's guide for further information and instructions.	Before Each Use	Weekly	Monthly	Every 3 Months	Every 6 Months	Every Year	As Necessary
Safety Equipment							
Check operation of the following items:							
Headlights, Taillights, and Marker Lights	◆		◆				
Turn Signals	◆		◆				
Horn	◆		◆				
Hazard Warning Flashers	◆		◆				
Windshield Wipers and Washers	◆		◆				
Fire Extinguisher - check charge indicator	◆		◆				
Smoke Alarm - test operation *	◆		◆				
Carbon Monoxide Alarm - test operation *	◆		◆				
Propane Gas Leak Detector - test operation	◆		◆				
(*replace battery if needed)							
Appliances							
Water Heater							
See water heater manufacturer's maintenance guide							◆
Inspect and clean exterior vent	◆						◆
Refrigerator							
See refrigerator manufacturer's maintenance guide							◆
Inspect and clean exterior vent/drip tray drain tube	◆						◆
Furnace							
See furnace manufacturer's maintenance guide							◆
Inspect and clean exterior vent	◆						◆
Air Conditioner							
See A/C manufacturer's maintenance guide							◆
Inspect for exterior damage				◆			◆
Check/replace filter			◆				
Range Top							
See range manufacturer's maintenance guide							◆
Inspect and clean/replace range hood grease filter							◆

COACH MAINTENANCE CHART

These recommendations apply for normal recreational use. Heavy duty or full-time use may require more frequent maintenance intervals.

Always use specified sections or manufacturer's guide for further information and instructions.	Before Each Use	Weekly	Monthly	Every 3 Months	Every 6 Months	Every Year	As Necessary
Sealants							
Inspect (see "Sealants - Inspection and General Information" at the beginning of this section for proper inspection technique)					◆		◆
Replace (see "Sealant Call-out Sheet" in the supplement manual provided in your InfoCase)							◆
Frame & Chassis							
Follow chassis manufacturer's maintenance guide (refer to chassis manual)							◆
Inspect hitch receiver (if towing)	◆						
Tires							
Check and adjust air pressure	◆						◆
Check tread wear	◆						◆
Check front end alignment and adjust if needed							◆
Miscellaneous							
Lubricate locks, hinges, and latches						◆	◆

LOADING THE VEHICLE

NOTE: Your motorhome's load capacity is designated by weight, not by volume, so you cannot necessarily use all available space when loading your motorhome.

- Store or secure all loose items inside the motorhome before traveling. Possible overlooked items such as canned goods or small appliances on the countertop, cooking pans on the range, or free-standing furniture items can become dangerous projectiles during a sudden stop or evasive maneuver.
- Be aware of GVWR, GAWR, and individual load limit on each tire or set of duals.

When loading the vehicle, distribute the cargo load equally so that you do not exceed either the Front or Rear Gross Axle Weight Rating (GAWR) or the Gross Vehicle Weight Rating (GVWR). The Gross Axle Weight Rating (GAWR) means the weight value specified by the chassis manufacturer as the load carrying capacity of a single axle system as measured at the tire-to-ground interfaces. This is the total weight a given axle is capable of carrying. Each axle has its own rating.

Have your vehicle weighed to determine the proper load distribution for your vehicle. Also distribute cargo side-to-side so the weight on each tire or dual set does not exceed one half of the GAWR for either axle.

For example, if the Front GAWR is 6,000 lbs., there should be no more than 3,000 lbs. on each tire. (If the left side weighs 3,100 lbs. and the right side weighs 2,700 lbs., at least 100 lbs. of the load must be shifted from the left side to the right side.) The GVWR is listed on the Vehicle Certification Label. (See sample in *Section 1 - Introduction*).

The GCWR (Gross Combination Weight Rating) means the maximum allowable loaded weight of this motorhome and any towed trailer or towed vehicle.

NOTE: We recommend that you dump all holding tanks before traveling to avoid carrying unnecessary weight.

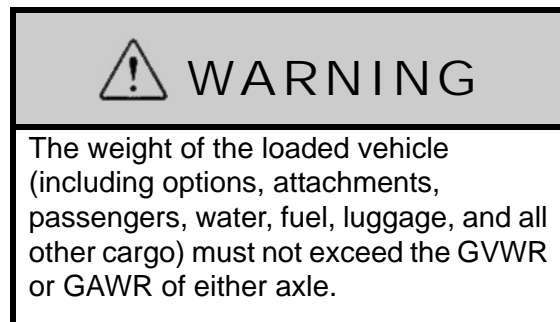

WEIGHING YOUR LOADED VEHICLE

To check the weight of your fully loaded coach, locate a commercial weighing scale that is capable of weighing large trucks.

NOTE: Sales literature may give approximate or standard weights. Your actual coach weight may differ based on added factory and/or dealer options.

Loading

Load your vehicle completely as if you were going on a long trip with everything you would carry, including food, clothing, bedding, lawn chairs, etc., a full fuel tank, full propane tank, and a partial tank of fresh water, but empty holding tanks.

Finding a Scale

In urban areas, the most common places to find a public access scale are commercial truck stops. In rural areas, most grain storage elevators have scales available. Most scales charge a nominal fee for weighing a vehicle.

Weighing

There is typically a scale operator to direct you but the basic routine is to take three separate weights - front axle, whole vehicle, and rear axle.

You will first drive only your front wheels onto the scale pad, then drive ahead so that the whole vehicle is on the scale, then finally pull off until just the rear wheels are on the pad.

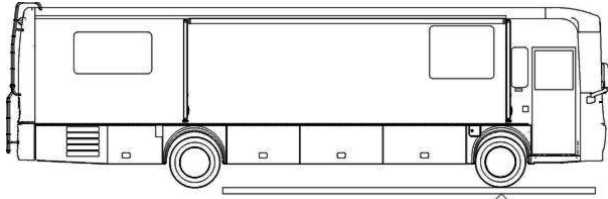

Front GAWR (Front Axle Only)

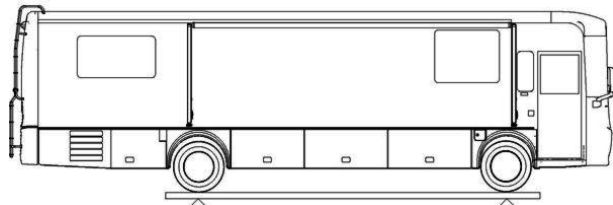

GVWR - Whole Vehicle (All Axles)

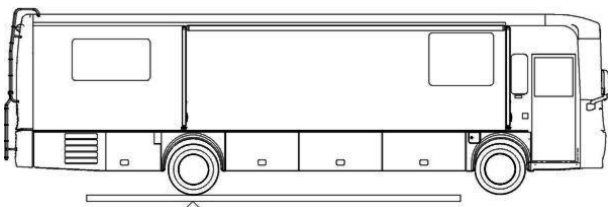

Rear GAWR (Rear Axle Only)

You will receive a weight “ticket” that states your current Front Gross Axle Weight, Rear Gross Axle Weight, and Gross Vehicle Weight. You can compare these weights to the weight ratings listed on your Vehicle Certification Label to use as a guideline for future loading limits and weight distribution.

The gross weight of the vehicle must not exceed the Gross Vehicle Weight Rating (GVWR) specified on the Vehicle Certification Label. The front and rear axle weight also should not exceed the corresponding Axle Weight Rating specified on the Vehicle Certification Label.

Corner Weighing (Side-to-Side)

The most accurate method of weighing a motorhome is to weigh each “corner” of the coach separately (single L/R front wheels or L/R rear dual sets.) This method will help you determine how to distribute your cargo to avoid overloading, especially on tires.

To determine the weight distribution on each tire or dual set, you will need to find a scale capable weighing side-to-side, or all four “corners” of the vehicle, separately.

A truck scale may be used if the ground is level with the scale surface and the scale has clearance to drive one side of the coach onto the scale as shown.

Drive the coach on the level area next to the scale and straddle the scale so that only one side of the coach will be on the scale pad.

NOTE: Wind and precipitation can also cause weight inaccuracies.

Pull only the right front wheel onto the scale pad as shown.

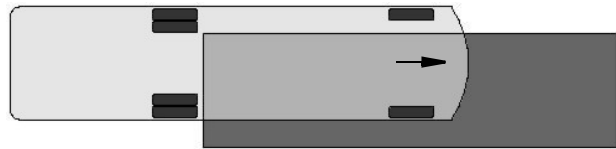

Weighing Right Front Corner

When the front wheel has been weighed, pull the coach straight ahead until only the right rear wheel/dual set is on the scale pad as shown.



Weighing Right Rear Corner

Now, turn the coach around and repeat the process for the other side.

The load on each wheel or dual-wheel set should not exceed one-half of the corresponding GAWR. For example, if the GAWR for the rear

axle is 12,000 lbs., then the load on each rear dual set (left rear duals or right rear duals) should not exceed 6,000 lbs.

Tires must be filled to the recommended air pressure for the highest loaded tire set on that axle. For example, on the rear axle, if the left side weighs more than the right, fill the left tires to the pressure required for that weight, then fill the right tires to the same pressure as the left ones.

If your actual weight is considerably less than GAWR, you may be able to lower your tire pressure. See a tire dealer for a load/pressure chart.

NOTE: The Hitch Load from a Towed Vehicle or carrier box must also be counted on the Rear GAWR and subtracted from the rear axle cargo capacity.

Be aware that hitch load can affect handling characteristics. The more weight on the hitch, the lighter the front end will feel at the steering wheel.

CAR OR TRAILER TOWING

Hitch Capacity*

5,000 lbs. max.

Tongue Weight*

500 lbs. max.

The factory installed towing hitch on this coach is capable of pulling 5,000 lbs. load (max.), however, the vertical (tongue) weight may vary according to chassis and model combinations (*see label on hitch). Towing capacity may be less than hitch rating.

When towing a trailer or vehicle, do not exceed either the GVWR, the rear axle GAWR, or the chassis GCWR by the combined loaded weight of the coach and the towed vehicle. *See preceding items "Loading the Vehicle" and "Weighing Your Loaded Vehicle" for explanation of weight ratings.*

Because of individual vehicle use and loading habits, we recommend weighing the vehicle while fully loaded to avoid exceeding any of the

listed Gross Weight Ratings. See "Vehicle Certification Label" in the Introduction section for information on gross weight ratings.

Towing will affect vehicle handling, durability, and fuel economy. Exceeding any of the listed Gross Weight Ratings will result in unacceptable overall vehicle performance. Maximum safety and satisfaction when towing depends on proper use of correct equipment.

When towing a vehicle behind your motorhome, the tow bar should be level or pointing slightly upward towards the tow vehicle.

When coupling the vehicle tow bar to the Factory Receiver Hitch using a "drop receiver" or a conventional "ball mount" (commonly referred to as a "stinger" or a "draw bar"), do not exceed a 4" drop, nor one that the centerline of the hitch pin to the centerline of the ball exceeds 8". See the following Hitch Assembly illustration.

If a towing "brake system" is required, we recommend that a "modulated" towed vehicle braking device be installed. This means that when the motorhome brakes are applied, whether hard or soft, a mirror effect occurs in the braking of the towed vehicle. In other words, the more force applied to the motorhome brakes, the more force will be applied to the rear vehicle's braking system.

We do not recommend the usage of a "surge-style" braking device. The usage of a surge brake (especially when coupled with a hitch ball located outside our recommended limits) places excessive stress on the hitch. This abuse of the ball mount and the hitch may cause premature hitch assembly failure.

Finally, do not forget to consider the actual tongue weight. This should not exceed the stated hitch vertical load for your vehicle. This weight is typically defined as the tongue weight of a towed vehicle hitch, boat trailer tongue weight, or a receiver-mounted carrier rack.

Check state regulations on trailer weight and trailer brake requirements to be sure you select the right equipment before towing.

Before descending a steep or long grade when towing a trailer, reduce speed and shift into a lower gear to control vehicle speed. Avoid prolonged or frequent application of brakes which could cause overheating and brake failure.

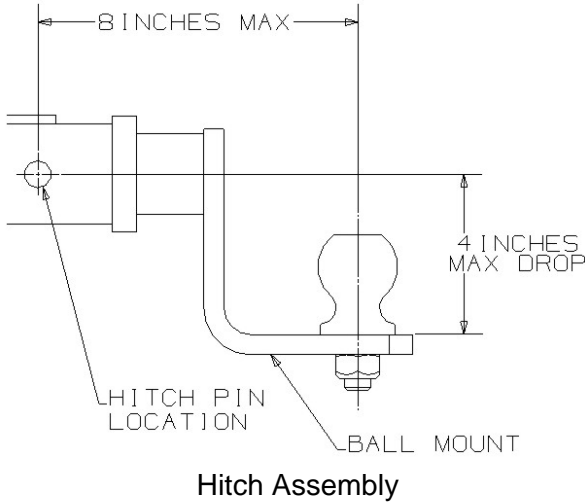

WARNING

For safe towing and vehicle handling, maintain proper trailer weight distribution. The total weight of the motorhome and the vehicle towed must not exceed the Gross Combined Vehicle Weight rating. See the “Body and Chassis Specification” chart in the Introduction section.

NOTICE

Exceeding any of the recommended gross vehicle weight ratings may result in vehicle damage. Do not install a frame equalizing-type hitch on your vehicle.

**TRAILER WIRING
CONNECTOR**

Your coach is pre-wired for trailer or car towing lights with a 7-pin socket.

The following diagram shows proper connection of trailer or tow vehicle wiring to the coach light system. The “pigtail” assembly with the (car/trailer end) connector plug should be wired by a qualified technician.

The trailer brake controller connector is located to the left of the steering column.

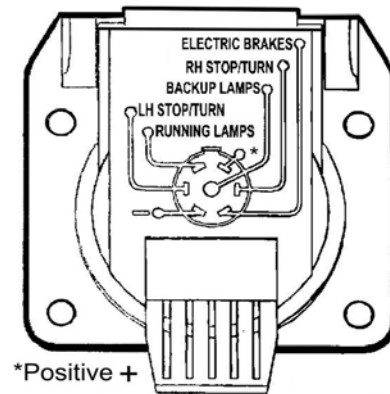

TOWING GUIDELINES

Gross Vehicle Weight Rating (GVWR)

This is the maximum allowable weight of the fully loaded vehicle. Included are fuel, water, LP, passengers, cargo, tools, and optional equipment installed by the motorhome manufacturer, dealer, or owner. This value is found on the VIN label, typically placed near the driver position.

Gross Axle Weight Rating (GAWR)

This is the total weight a given axle is capable of carrying, measured at the ground. Each axle has its own rating. These values are also found on the Vehicle Certification Label: front and rear.

Gross Combination Weight Rating (GCWR)

This is the maximum allowable weight of the motorhome and loaded trailer, including the items noted in GVWR above. For purposes of

this definition, the “trailer” can be a trailer, a vehicle towed on a dolly, or a vehicle towed by means of a tow bar. GCWR is typically specified based on durability and performance of the tow vehicle drive train: engine and cooling systems, transmission, drive line, drive axle, and others. The tow vehicle brakes may be rated for operation at GVWR, not GCWR.

NOTE: State or provincial laws/regulations may require the “trailer” to be equipped with brakes that are activated when the motorhome brakes are applied. The user is responsible to know and understand the laws of the state or province being traveled. The Department of Transportation in a given state or province should be able to provide specific information.

Hitch Ratings

SAE Standard J684 defines:

- Class 1 trailers as “GVWR not to exceed 2,000 lbs”.
- Class 2 trailers as “GVWR over 2,000 lbs. and not to exceed 3,500 lbs. GVWR”.
- Class 3 trailers as “GVWR over 3,500 lbs. and not to exceed 5,000 lbs. GVWR”.
- Class 4 trailers as “GVWR over 5,000 lbs. and not to exceed 10,000 lbs. GVWR”.

Hitches are to be permanently marked with “Maximum trailer GVWR to be drawn” and “Maximum vertical tongue weight to be imposed.” The SAE standard does not specify a vertical load rating.

Traditionally, hitches are labeled 3,500/350 as Class 2, 5,000/500 as Class 3, and 10,000/1,000 as Class 4. The vertical tongue load value of 10 percent of drawn rating comes from the collective experience that 10 percent is the minimum value that provides stable towing of a trailer.

Ford’s towing guide suggests 10 to 15 percent for trailers over 2,000 lbs. Within GCWR, a Class 3 hitch allows “dingy” towing a large car or

mid-size SUV; a Class 4 hitch allows “dingy” towing a large SUV or pickup. (Hitch ratings are independent of towing vehicle ratings.)

NOTE: Some Winnebago Industries® models equipped with a Class 3 hitch may have a label limiting vertical tongue load to 350 lbs. All Winnebago Industries models equipped with a Class IV hitch have a label limiting vertical tongue load to 500 lbs. On a 228” wheelbase, a 500-lb. load on a hitch 11’ from the rear axle will apply about 800 lbs. at the axle.

The user must verify that the hitch equipment being used is adequate for the application.

ENTRY STEP – ELECTRIC

–If Equipped

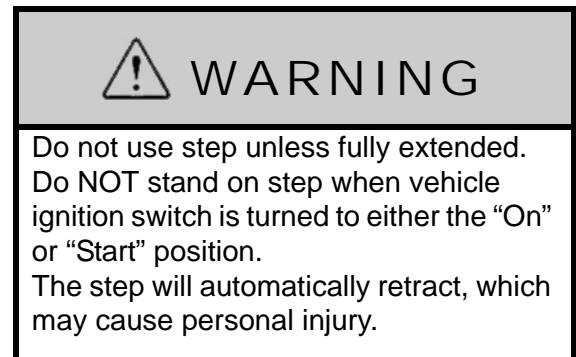

The power switch for the electric entry step is located to the left of the main entry door as you enter the coach.



Entry Step Switch
(Located near entrance door)
-Typical View

The step has several automatic extend/retract functions that are controlled by the position of a sensor mounted on the inner edge (hinge side) of the screen door.

Automatic Mode - Entry Step Switch ON

(Step Operates with Door)

With the Step switch in the ON position, the step is in Automatic Mode. This means it will extend and retract automatically whenever the screen door is opened or closed.



Red Activation Lever

- The red Activation Lever located on the entry step switch must be depressed in order to put the step switch in the ON position.

Stationary Extended Mode - Step Switch OFF

(Step Remains Extended)

With the Step power switch in the OFF position, the step will extend when the screen door is opened and will stay extended whether the door is opened or closed.

NOTE: The step switch is “locked” in the OFF position.

This position is normally used to keep the step extended when parked at a campsite or whenever people will be going in and out the vehicle frequently.

Automatic Retraction Feature

The step is equipped with an automatic retraction feature that stores the step automatically if the main entry door is closed and the Ignition Switch key is turned to the On or Run positions.

The step **WILL RETRACT** even if the Step switch is OFF.

This feature is intended to prevent injury or damage by an extended step while the vehicle is moving.

Further Information

For additional information on the step, see the manufacturer’s operators manual included in your InfoCase.

WINDOWS

Crank-Out Windows

- To open, pull out the lever on the window handle and begin cranking the window out “counter-clockwise” to desired position.



- To close, crank the window in snugly (by turning the window handle “clockwise”), then back off 1/4 turn to help avoid glass warping, which can result in wind noise.
- Push the lever back in on the window handle.

If the window will not open after three or more full turns of the knob, the glass may be stuck to the sealing gasket. Go to the outside of the coach and gently free the glass with your fingers. A periodic light dusting of talcum powder on the gasket should prevent this from recurring.

Horizontal Slider Windows

Swing the latch handle straight out or up (depending on the style of window). Grasp the sliding window edge frame and slide the window to the side. Ensure the latch is open before trying to slide the window closed.



Vertical Slider Windows

Vertical windows have spring-loaded catches on both sides of the window that pop out to hold the window in its fully raised position. Press the catches outward toward the frames while lowering the window.



POWER ROOF VENTILATOR

Lounge, Galley, or Bath Area –If Equipped

The vent dome is raised and lowered using the Dome Crank knob on the fan.

The turbine fan will start automatically as the vent is raised, and stop as the vent is lowered.

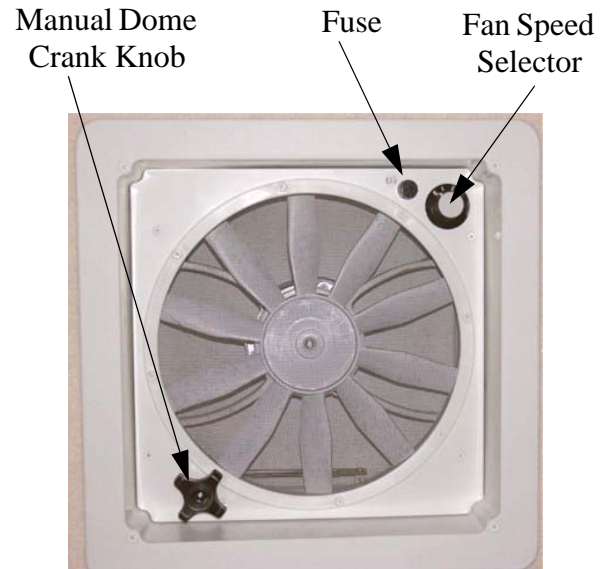

Power Roof Ventilator

To Operate Ceiling Ventilator

1. Turn the Dome Crank Knob to raise the dome about 3" or more to allow the turbine fan to operate. *(A built-in safety switch will not let the fan motor run unless the dome is partially open).*
2. The turbine fan will start automatically as the vent dome is raised and stop as the vent dome is lowered and closed. *(Fan Power switch must be ON and Fan Speed knob in a position other than 0-Off).*
3. Turn the Fan Speed knob to the desired level (0-Off, 1-Low, 2-Med, 3-Hi).
4. Open a window or door to provide airflow. Direction of airflow is determined by which window or door is opened.

NOTE: For best results, close all other roof vents, windows, and doors, then open one (1) window the farthest distance from the roof ventilator. The fan speed selector on the fan allows you to adjust the amount of circulation you need at any time.

5. If you want the vent dome raised without the fan running, turn Off either the Fan Power switch or Fan Speed knob (0-Off).

Further Information

See the power ventilator manufacturer's operating instructions supplied in your InfoCase for further instructions, care, and cleaning information.

**POWER ROOF VENTILATOR
WIRING**

This coach is pre-wired for installation of a powered roof ventilator. The wires are located in the roof near the existing galley/lounge roof vent.

See your authorized Winnebago Industries® dealer for proper installation and sealing of roof mounted components.

POWER AWNING

-If Equipped

The Power Awning switch is located on the control panel just inside the entrance door.



Power Awning Switch
(Located near entrance door)
-Typical View

Operating the Awning

- Press the Power Awning switch IN or OUT to extend or retract the Awning as desired.

Ignition Lockout System

The ignition lockout system will disable the extend function while the vehicle ignition key is in the On position. With this feature, the Awning will only extend when the vehicle ignition key is in the Off position. The Awning can retract anytime regardless of the ignition key position.

Further Information

For complete operating instructions, features, safety precautions, and maintenance care, refer to the Awning manufacturer's user guide provided in your InfoCase.

**STORAGE COMPARTMENT
DOORS**

The high-density gaskets used on the exterior storage compartments are designed to provide a more positive seal against dust and weather.

To ensure that exterior storage compartment doors have latched properly, press firmly on the bottom edges of the doors with the palms of your hands while twisting latches.

TOOL AND LADDER STORAGE

The roof ladder extension and various tools supplied with your coach are stored in one or more of the exterior storage compartments.

NOTE: Actual features and locations may vary depending on model, available equipment, and storage compartment configuration.

ROOF LADDER

-If Equipped

 WARNING
Stay off roof. Roof surface may be slippery. Falling could result in death or serious injury.

The ladder on your vehicle is provided for limited access to the roof.

Walking or working on the roof should be left to qualified service personnel using proper safety equipment in a safe environment. You should only walk or work on the roof if you are qualified and have created a safe environment.

For your safety, it is not recommended that you store or carry items on the roof.

Before Using the Ladder

- **Inspect the ladder** to make sure it is not damaged. Never use a damaged ladder.
- **Keep the rungs of the ladder clean and dry** while in use. Never use the ladder when it is raining, snowing, or icy. The rungs can become slippery. Do not step onto the rungs if the rungs are wet, or if your shoes are wet or carry mud or debris that could result in a loss of footing.
- **Never ignore warning labels** or weight limits defined on your ladder. The following warning label is located on or near the ladder:

 **WARNING**

Do not exceed 225-lb. maximum weight capacity.
Misuse of ladder could result in death or serious injury.
See Operators Manual before using ladder.

- **Maximum Capacity: 225 lbs.**
- **Do not overload.** Ladder is intended for one person.
- **Make sure you are physically capable** to safely use the ladder. Strength, flexibility, and stability are required.
- **Be aware that the vehicle may sway** as you climb the ladder. Do not use the ladder in high winds.
- **As you climb the ladder,** grasp the side rails firmly and always use both hands. Keep your body centered between the side rails. Do not over-reach.
- **Never allow children** on the ladder.
- **Do not transport items** anchored to the ladder. You could damage the ladder.

EFFECTS OF PROLONGED OCCUPANCY

Your motorhome was designed primarily for recreational use and short-term occupancy. If you expect to occupy your coach for an extended period, be prepared to deal with condensation and humid conditions that may be encountered.

Humidity and Condensation

Moisture condensing on the inside of windows is a visible indication that there is too much humidity inside the coach. Excessive moisture can cause water stains or mildew, which can damage interior items such as upholstery and cabinets.

When you recognize the signs of excessive moisture and condensation in your coach, you should take immediate action to minimize their effects.

You can help reduce excessive moisture inside the motorhome by taking the following steps:

Ventilate with outside air

Partially open one or more windows and a roof vent to circulate outside air through the coach. In cold weather, this ventilation may increase use of the furnace, but it will greatly reduce the condensation inside the coach.

Minimize moisture released inside the coach

Run the range hood fan while cooking and open a bath vent while bathing or showering to carry water vapor out of the coach. Avoid making steam from boiling water excessively or letting hot water run. Avoid bringing extra moisture into the coach by way of soaked clothing or snow on shoes. Do not hang-dry wet overcoats or clothing inside the coach.

Chalet

INDEX

About this Manual	1-1	Driving Safety	2-1
Air Conditioner Filter	4-11	Ducted Roof Air Conditioning System	4-11
Air Conditioner/Heater – Automotive (Dash)	3-8	DVD Player	8-1
Audio/Video System Cables	8-1	Effects of Prolonged Occupancy	12-9
Audio-Video System Basic Operation	8-1	Electrical	2-5
Bathroom	11-10	Electrical Cautions	6-1
Battery Access	6-8	Electrical Generator – 120-Volt	6-6
Battery Boost Switch	3-7	Electrical Outlets – House 120-Volt AC	6-5
Battery Care	6-9	Electrical System – House 120-Volt AC	6-1
Bedroom DVD/Satellite Receiver Connection	8-4	Electrical System – House 12-Volt DC	6-7
Brake-Shift Interlock	3-6	Emergency Exits	2-6
Buffet Table and Chairs	9-1	Engine Access – Interior	3-10
Cabinetry – Cleaning	11-8	Engine Cooling System	3-11
Car or Trailer Towing	12-3	Engine Overheat	2-10
Carbon Monoxide Alarm	2-3	Entry Step – Electric	12-5
Carbon Monoxide Warning	2-3	Extendable Sectional Sofa	9-12
CB Radio Power Wiring	3-9	Exterior Automotive Paint Finish	11-2
CD/DVD Player	8-2	Exterior Entertainment Center	8-6
Ceiling Fabric Care	11-7	Exterior Entertainment Center	8-7
Chassis Battery Disconnect Switch	3-12	Exterior Graphic Care	11-4
Chassis Service and Maintenance	11-12	Exterior Shower/Wash Station	7-5
Checking Hydraulic Oil Level	10-13	External Power Cord	6-1
Child Restraints	3-3	Fire Extinguisher	2-5
Circuit Breakers – House 120-Volt AC	6-5	Flip-Down Screen Video Players	8-3
Circuit Breakers and Fuses – Chassis/Dash Automotive 12-Volt	3-13	Formaldehyde Information	2-7
Circuit Breakers and Fuses – House 12-Volt DC	6-10	Fresh Water System	7-1
Coach Maintenance Chart	11-13	Front Axle Tire Alignment	1-2
Comfort Sofa Sleeper	9-9	Front Service Access	3-10
Defrost Fans	3-8	Front TV Ignition Switch Interlock	8-1
Dinette Conversion	9-6	Fuel and Propane Gas	2-1
Dinette/Bed Conversion - Dream Dinette™	9-4	Galley Sink	11-9
Dinette/Bed Conversion	9-3	General Slideout Care	10-11
Disinfecting Your Fresh Water System	7-4	General Warnings	2-1
Doors and Windows	11-10	Ground Fault Circuit Interrupter	6-6
Drainage System (P-Traps)	7-6	Hazard Warning Flashers	3-7
		Heat Pump	4-10
		Heater – Rear Coach (Automotive)	3-8
		House/Coach Battery Disconnect Switch	6-8
		Interior Soft Goods	11-5

Inverter Unit – 1000W	6-3	Rearview Monitor System	3-5
Jump Starting	2-9	Refrigerator	4-1
Keys	3-5	Refrigerator Service Access Compartment ..	4-2
Leveling System	10-11	Reporting Safety Defects	1-2
Lights	3-12	Roadside Emergency	2-9
Loading	2-5	Roller Shades (Manual) - Solar Day/Night	9-13
Loading the Vehicle	12-1	Roof	11-1
Lounge Chair – Swivel Glider	9-1	Roof and Ladders	2-7
Maintenance	2-6	Roof Ladder	12-8
Map Light Switch	3-7	Safe Use of the Propane Gas System	5-2
Microwave Oven	4-4	Safety Messages Used in this Manual	1-1
Microwave Oven/Range Hood	4-4	Satellite Dish and Cable TV Connections ...	8-6
Mirrors – Power Electric	3-6	Sealants – Inspection and	
Mold, Moisture, and Your Motor Home	2-8	General Information	11-1
MotorAid Water Heater	4-8	Seat Belts	3-2
Occupant and Cargo Carrying		Seats – Driver/Co-Pilot	3-1
Capacity Label	1-3	Service and Assistance	1-2
Owner and Vehicle Information	1-6	Shower Hose Vacuum Breaker	7-5
Park Brake – Foot Pedal	3-6	Sleeping Facilities	9-1
Plastic Parts – Cleaning	11-4	Slideout Emergency	
Power Awning	12-8	Retraction - Bedroom	10-10
Power Center	6-4	Slideout Emergency Retraction	
Power Control System (PCS)	4-6	(Power Gear®)	10-8
Power Roof Ventilator	12-7	Slideout Emergency Retraction	
Power Roof Ventilator Wiring	12-8	(Power Gear®)	10-9
Pre-Delivery Inspection	1-2	Slideout Room – Extreme	
Pressure-Temperature Relief Valve	4-8	Weather Precaution	10-5
Propane Gas Furnace	4-9	Slideout Room Operation – Electric	10-3
Propane Gas Leak Detector	2-3	Slideout Room Travel Lock	10-2
Propane Gas Leaks	2-2	Slideout Room Travel Locks - Electric	10-1
Propane Gas Pressure Regulator	5-4	Slideout Room Troubleshooting	10-6
Propane Gas Supply	5-1	Slideout Rooms	2-6
Propane Gas Warnings and Precautions	5-3	Smoke Alarm	2-4
Propane Vaporization in Cold Weather	5-5	Sofa/Bed Conversion	9-7
Radio - In-Dash	3-9	Sofa/Bed Conversion	9-7
Radio – In-Dash	3-9	Sofa/Bed removable Armrests	9-8
Radio Power Switch	3-9	Specifications and Capacities	1-5
Range and Oven	4-2	Stainless Steel Appliances	11-8
Range and Refrigerator	11-9	Storage Compartment Doors	12-8
Range Hood	4-4	Suspension Alignment and Tire Balance ...	3-12
Rear Air Conditioner Power		Systems Monitor Panel	4-4
Selector Switch	4-11	Tables and Countertops	11-8

Chalet

Tires	3-12
Toilet	7-6
Tool and Ladder Storage	12-8
Tow/Haul Transmission Mode	3-7
Towing Guidelines	12-4
Trailer Wiring Connector	12-4
TV Antenna - Digital	8-5
TV Digital Satellite System Wiring	8-6
TV Signal Amplifier	8-6
Undercarriage	11-1
U-Shaped Dinette/Bed Conversion	9-5
Vehicle Certification Label	1-4
Vehicle Storage – Preparation	11-11
Vehicle Storage – Removal	11-11
Vinyl Flooring	11-9
Waste Water System	7-6
Waste Water System (Waste Pump)	7-8
Water Heater – Gas	4-7
Water Heater - Gas/ Electric	4-7
Water Heater Bypass Valve	7-11
Water Pump	7-2
Water System Drain Valve Locations	7-17
WaterLine & Tank Drain Valves	7-10
Weighing Your Loaded Vehicle	12-1
Windows	12-6
Winterizing Procedure	7-12
Wood Furniture and Cabinetry	9-13